

# CLASSIC BATTLETECH

TM

TECHNICAL™  
READOUT:

3

0

5

0

UPGRADE

# TABLE OF CONTENTS

<b>INTRODUCTION</b>	4	Hatamoto-chi	88	Demon	170
<b>INNER SPHERE BATTLEMECHS</b>	6	Victor	90	Marksman	172
Flea	8	Zeus	92	Magi	174
Hornet	10	Katana (Crockett)	94	Burke	176
Commando	12	Shogun	96	Fury	178
Falcon	14	Stalker	98	Rhino	180
Firefly	16	Cyclops	100	Puma Assault Tank	182
Javelin	18	Mauler	102	<b>Star League BattleMechs</b>	184
Spider	20	Banshee	104	Mercury	184
UrbanMech	22	Annihilator	106	Thorn	186
Firestarter	24	Atlas	108	Mongoose	188
Jenner	26	Imp	110	Hermes	190
Panther	28	<b>CLAN OMNIMECHS</b>	112	Hussar	192
Raven	30	Dasher	114	Sentinel	194
Wolfhound	32	Koshi	116	Wyvern	196
Assassin	34	Uller	118	Crab	198
Cicada	36	Puma	120	Kintaro	200
Clint	38	Dragonfly	122	Champion	202
Hermes II	40	Fenris	124	Lancelot	204
Vulcan	42	Black Hawk	126	Bombardier	206
Whitworth	44	Ryoken	128	Exterminator	208
Blackjack	46	Vulture	130	Guillotine	210
Hatchetman	48	Loki	132	Black Knight	212
Vindicator	50	Thor	134	Flashman	214
Wolf Trap	52	Mad Cat	136	Thug	216
Centurion	54	Man O' War	138	Crockett	218
Enforcer	56	Masakari	140	Highlander	220
Hunchback	58	Gladiator	142	King Crab	222
Trebuchet	60	Daishi	144	<b>Star League Aerospace Fighters</b>	224
Dervish	62	<b>STAR LEAGUE</b>	146	Trident	224
Hoplite	64	<b>Star League Vehicles</b>	148	Swift	226
Grand Dragon	66	Gabriel	148	Spad	228
Quickdraw	68	Ripper	150	Zero	230
Axman	70	Beagle Tank	152	Rogue	232
Catapult	72	Rotunda	154	Tomahawk	234
JagerMech	74	Nightshade	155	Hellcat	236
Caesar	76	Cyrano	158	Gotha	238
Cataphract	78	Lightning	160	Ironsides	240
Grasshopper	80	Zephyr	162	Hammerhead	242
Orion	82	Chaparral	164	Rapier	244
Awesome	84	Kanga	166	Ahab	246
Charger	86	Thor Artillery Vehicle	168		

## TECHNICAL READOUT: 3050 UPGRADE

### TECHNICAL READOUT: 3050 ORIGINAL EDITION

#### Writing

J. Andrew Keith  
Jim Musser

#### Development

Sam Lewis

#### Editorial Staff

*Senior Editor*  
Donna Ippolito  
*Assistant Editor*  
Kent Stolt

#### Playtesters

*The Ariston Game Club:*  
Bill Webb  
Christina  
Kevin William  
Eric J. Smith  
Phil Schumer  
Larua Lee  
Dave Brave

#### Production Staff

*Art Director*  
Jim Nelson  
*Production Manager*  
Sam Lewis  
*Cover*  
Jim Nelson  
*Illustrations*  
Joel Biske  
Jim Nelson  
Dana Knutson  
Steve Venters  
*Layout*  
Tara Gallagher

### TECHNICAL READOUT: 3050 REVISED EDITION

#### Original Technical Readout: 2750 material by

Clare W. Hess    Blaine L. Pardoe  
Dale L. Kemper    Boy F. Petersen, Jr.  
Jim Long

#### Additional Material by

Sam Lewis

#### BattleTech Line Developer

Bryn Nystul

#### Development

Bryan Nystul  
Randall N. Bills

#### Editorial Staff

*Editorial Director*  
Donna Ippolito  
*Managing Editor*  
Sharon Turner Mulvihill  
*Associate Editors*  
Diane Piron-Gelman  
Rob Cruz  
*Editorial Assistance by*  
Karen Stange

#### Production Staff

*Art Director*  
Jim Nelson  
*Project Manager*  
Jim Nelson  
*Front Cover Art*  
Jim Nelson  
*Back Cover Art*  
C. Sterns  
*Cover Design*  
Mike "Skuzzball" Nielsen  
*B&W Illustrations*  
Joel Biske    Dana Knutson  
Jim Nelson    Steve Venters  
*Layout*  
John Bridegroom

### TECHNICAL READOUT: 3050 UPGRADE

#### Writing

Herb A. Beas II  
Randall N. Bills  
Chris Hartford  
Ken' Horner  
Kevin Killiany  
Nick Marsala  
David McCulloch  
Ben Rome  
Jason Schmetzer  
Christoffer Trossen  
*Additional Contribution*  
Jack Mc Crary

#### Product Development

Randall N. Bills  
*Assistant Development*  
Mike Miller  
Chris Wheeler

#### Production Editing

Jason Hardy

#### BattleTech Line Developer

Randall N. Bills

#### Production Staff

*Art Direction*  
Randall N. Bills  
*Cover Art*  
Doug Chaffee  
*Cover Design*  
Ray Arrastia  
*Layout*  
Ray Arrastia  
*Illustrations*  
Doug Chafee  
Brent Evans  
Chris Lewis  
Jim Nelson  
*Classic BattleTech Logo Design*  
Shane Hartley and Steve Walker

#### Proofers

Paul Bowman, Rich Cencarik, Christopher K. Searls, Peter Smith, Patrick Wynne.

#### Special Thanks

Once again I have to thank Mike Miller and Chris Wheeler who jumped in feet first to help keep this project rolling forward when so many other critical things kept getting in the way.

©2007 WizKids, Inc. All Rights Reserved. Classic BattleTech Technical Readout: 3050 Upgrade, ClassicBattleTech, BattleTech, Mech, BattleMech, MechWarrior and WK Games logo are registered trademarks and/or trademarks of WizKids, Inc in the United States and/or other countries. No part of this work may be reproduced, stored in a retrieval system, or transmitted in any form or by any means, without the prior permission in writing of the Copyright Owner, nor be otherwise circulated in any form other than that in which it is published.

Published by Catalyst Game Labs,  
an imprint of InMediaRes Productions, LLC  
PMB 202 • 303 91st Ave NE • G701 •  
Lake Stevens, WA 98258

#### FIND US ONLINE:

Precentor\_martial@classicbattletech.com  
(e-mail address for any  
Classic BattleTech questions)  
<http://www.classicbattletech.com>  
(official Classic BattleTech web pages)  
<http://www.CatalystGameLabs.com>  
(Catalyst web pages)  
<http://www.wizkidsgames.com/mechwarrior/>  
(official MechWarrior web pages)  
<http://www.wizkidsgames.com>  
(WizKids web pages)  
<http://www.battlecorps.com/catalog>  
(online ordering)

**T**his manual is intended to assist members of Our Blessed Order who have recently completed their training as Acolytes, bringing them up to date on the events in this outer world. The incredible changes in politics and technology following the Fourth Succession War are nothing compared to the total transformation of the Inner Sphere that has occurred over the past two years. The Successor States are cooperating to a degree unthinkable even three years ago, a powerful new adversary has captured more than 100 worlds, and military technology has run rampant.

The rapid pace of events and even more rapid proliferation of sophisticated weaponry have delayed the issue of this book. Intended for release in 3050, as stated in the title, the book would have been out of date before it reached the hands of its intended readers. Precentor XX-eta Lilith Sebastian wisely ordered wholesale revisions before the volume reached the printer. The cover, unfortunately, could not be called back.

So it is in 3052 that this volume brings our newest Acolytes abreast of the latest BattleMech equipment of all parties in the Inner Sphere, except, of course, Our Blessed Order. Our equipment has not, of course, changed for centuries, and Acolytes make an in-depth study of our military capacities as part of their basic training.

It is important to remember that Clan weapons are superior in performance to those of the Inner Sphere, even though the same terminology is used to discuss the weapons and equipment for both Clans and Inner Sphere. I need not remind you of the terrible consequences should this, or any ComStar document, fall into the hands of anyone outside Our Order.

I am honored that Precentor XX-eta Lilith Sebastian commissioned me to oversee the research and writing of this document. I also thank Precentor Martial Anastasius Focht for his help, especially in the sections on the Clans. The commander of the Com Guards spent many months as envoy to the Clans, and his information and insight have been invaluable. The information about the Inner Sphere response came mostly from the files of Precentor XV-delta Raymond Little, whose assistance helped make this work possible.

It is the hope of all involved with this project that our newest Acolytes will use this information in this book to help achieve our great task of reunifying mankind, according to the Word of Blake

—Merle Jimmus  
Adept XXI-sigma  
ComStar Archives, Terra  
8 February 3052

Ever since the data vaults of ComStar were opened to the public in the years following Tukayyid, millions of readers have consulted this vital reference work graciously provided by the so-called “new” ComStar. Our agents have acquired the original files of this document and have discovered startling inconsistencies and omissions. These “mistakes” are clearly attempts by ComStar to conceal its own level of technology and whitewash its checkered past.

In this edition, wherever possible, we have made corrections and additions to correct such inaccuracies and omissions. Of particular interest are the various Star League-era 'Mechs and vehicle files, which were removed from the original document by ComStar censors. In previous Technical Readouts, ComStar claimed these machines had completely disappeared, victims of the Succession Wars or Kerensky's Exodus. As we now know, many of them are still in service, either with ComStar itself or the Clans, although the Clans relegate such machines to garrison duty. To make space for these additions, other 'Mechs had to be removed by our editors. However, the text of their descriptions needed no alterations, so scholars can still rely on the original data for those aging designs.

—Major-General Margaret Tulliver  
Deputy Director, Wolfnet  
22 March 3058

How naive I sound. How full of myself, confident of ComStar's faults and our own righteous indignation. Confident we'd missed nothing: the guard against ComStar for the Inner Sphere. How we failed.

Following the publication of the revised document of ComStar's original *Technical Readout: 3058*, I could barely find the heart, much less the strength to continue. The crushing responsibility of our failure—of Wolfnet's failure—weighed heavily. Yet the Dragoons are ever tenacious, and what might kill a lesser animal only brings out the feral side. We have failed, but in pushing forward, in continuing the fight, we hope to overcome. Despite the lack of resources and the raging conflict all around us, the Herculean effort of Ryn Nikoli and her team have produced invaluable data.

Another decade has seen a plethora of additional technologies make their way onto the modern battlefield and the centuries-old machines detailed within these pages have once again gone through a renaissance of technological transformation. And unlike when the designs were rapidly converted during the Clan invasions, these more time-tested variants are generally far more lethal.

Through our newly acquired connections with Clan Wolf (in-Exile), we finally have a definitive look at the history of the groundbreaking Clan OmniMechs, as well as the latest Clan weaponry and Omni configurations.

Finally, in the previous published edition, I noted the importance of the Star League omissions on ComStar's part. That more true now than ever, as so many of those pivotal designs march in the armies of our most hated enemy: the Word of Blake. I've completely reorganized the book to emphasize the Star League designs, while updating that section to provide a crystal-clear picture of what our allies in this Jihad may face.

God save us all.

—Major-General Margaret Tulliver  
Deputy Director, Wolfnet  
31 December 3071

## GAME NOTES

Many of the variants and configurations that are new in *Technical Readout: 3050 Upgrade* are constructed with weaponry found in *Classic BattleTech Total Warfare*; the construction rules for said equipment can be found in *Classic BattleTech TechManual*. Additionally, note that some designs were slightly modified from previous publications to make them fully compatible with the construction rules as presented in *TechManual*.

Several units mount weapons and/or equipment not found in *Total Warfare* or *TechManual*, or mount equipment they cannot mount under those rules sets. They are: *Catapult*, *Chaparral*, *Kanga*, *Thor Artillery Vehicle*, and *Marksman*. The rules governing the use of their weapons and their construction are beyond the Standard Rules presented in *Total Warfare* and *TechManual*. They are covered in the Advanced Rules presented in *Classic BattleTech Tactical Operations*.

All Battle Values listed in this book were generated using the Battle Value system as it appears in *TechManual*. If a unit lists a NA under Battle Value, then it falls into the Advanced Rules category, as described above.



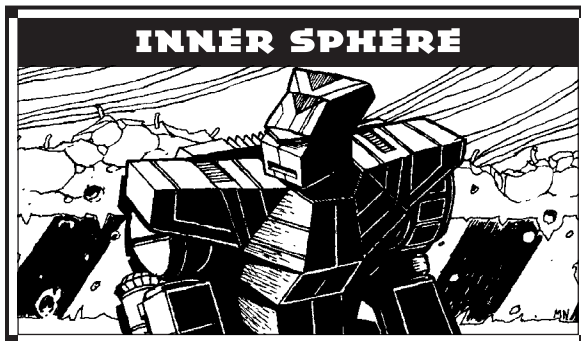

In these military technical readout briefings, the discussion of the technological renaissance of the last few decades is often quoted, making it feel as though we are simply treading over the same ground again and again. Yet as each stellar empire marches to war in this Jihad, they casually field technologies unavailable for centuries. Entire generations fought and died while leaders strove one with another, all the while only dreaming of the technologies so common today. Just as knowing an enemy is critical, knowing the genesis of today's technologies can also be important.

By the start of the thirty-first century, the Inner Sphere had settled into a state of near-constant war. However, unlike the fighting of the First and Second Succession Wars, these were not massive armies marching across endless worlds. Instead, it was a never-ending parry of sword-raids on important worlds. For the first time in hundreds of years, the Inner Sphere was able to focus beyond simple attack and defend strategies and could take the long view to see what had been lost.

In 3014, Hanse Davion led a raid on the world of Halstead Station, where he captured portions of an ancient Star League library. Using that material, he established the New Avalon Institute of Science, the Inner Sphere's largest and most prestigious university, with a primary goal of beating back the darkness of lost technologies across two centuries. Other House leaders took note of the development and followed suit in their own way.

Then, in 3028, mere months before the start of the Fourth Succession War, a watershed event occurred: the discovery of the Gray Death Memory Core on Helm. Already primed, the empires of the Inner Sphere gained access to the memory core and threw themselves into developing technologies. War, always a catalyst for advancing technologies, occurred in a large fashion in 3039, helping push technologies to new heights.

Then the Clans arrived in 3049. Nothing spurs technology like a war—especially a war with an enemy that fields vastly superior equipment. Already prepared through decades of decoding the Memory Core, the Inner Sphere was galvanized by the arrival of the Clans and the desperate need to field better technology to stave off the endless barbarian hordes.

Most of the 'Mechs detailed in this briefing originally faced the Clans with hasty refits of Inner Sphere technology built across those last decades. While this provided some benefits, the designs were completely out-classed and were destroyed in droves. This led directly to the development of designs constructed from the ground up to incorporate cutting-edge technologies (see the *Technical Readout: 3055 Upgrade* intelligence briefing). Yet these venerable designs still represented the vast majority of BattleMechs fielded by the stellar empires. As better and more advanced technologies became cheaper and easier to produce, these machines finally began to receive the upgrades that would allow them to compete on the modern battlefield.

Finally, it is important to note that the more astute reader may notice subtle differences to many of the 'Mechs detailed in this document. The reasons for this are multitude. In some cases they represent simple errors introduced by hurried ComStar Adepts in the midst of the Clan Invasion, and by the loss of critical Wolfnet personnel and records in the ongoing Jihad. In others, they represent new factory lines for centuries-old designs and new facilities requiring alternate supplies of components. The damage wrought in the Jihad has also brought many changes in design, as production facilities have been captured or destroyed, forcing manufacturers to utilize whatever sources of components they can acquire. Last but not least, in some cases these changes represent genuine innovations; better chassis, weapons, and electronics. Spurred on by the Clans themselves—with their modular components and unified engineering standards—numerous Inner Sphere manufactures have started to produce components to common standards. While once limited to specific brands of components—such as engines—advances in manufacturing, alongside companies looking to maximize both their customer bases and profits, have led to many 'Mech designs being able to sport a plethora of differing components without the need for lengthy overhauls or custom-built modifications.

—Captain Ryn Nikoli  
Battlefield Intelligence, Wolfnet  
8 October 3071

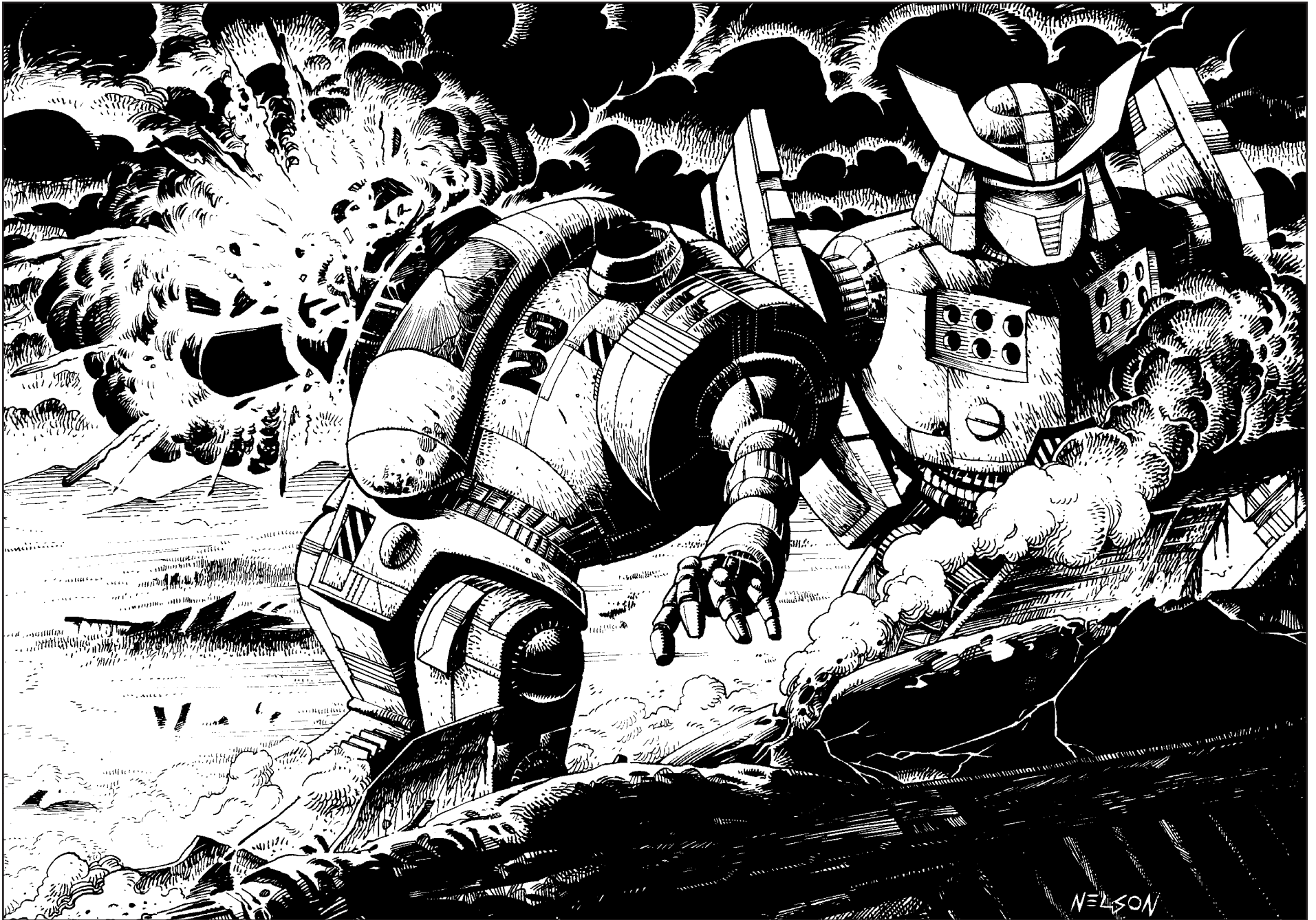

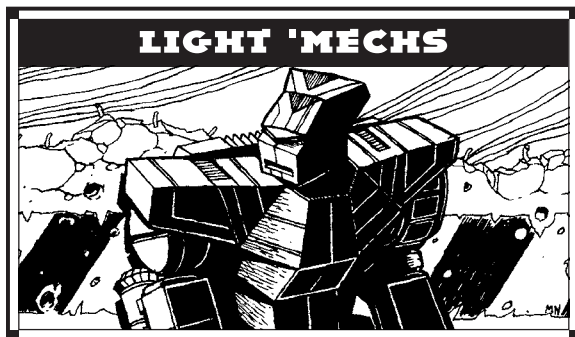

**Mass:** 20 tons

**Chassis:** Earthwerk Trooper II EndoSteel

**Power Plant:** GM 120

**Cruising Speed:** 64 kph

**Maximum Speed:** 97 kph, 119 kph w/MASC

**Jump Jets:** None

**Jump Capacity:** None

**Armor:** Livingston Ceramics

**Armament:**

2 Martell Medium Pulse Lasers

1 Olympian Flamer

2 Martell Small Lasers

**Manufacturer:** Earthwerks Incorporated

**Primary Factory:** Asuncion, Bernardo, Victoria

**Communications System:** Neil 2000

**Targeting and Tracking System:** Dalban HiRez-B

## Overview

A rare design first found in large quantity with Wolf's Dragoons, the *Flea* saw increased production during the 3040s. After the Capellan Confederation acquired the blueprints from a Maskirovka operation in the mid-3040s, Earthwerks allowed the Dragoon contract's exclusivity clause to lapse, and they began selling to all interested parties. The *Flea* found immediate use with the Confederation's numerous militias.

With the Confederation's recent gains in stealth technology and light weaponry, the *Flea* became a natural test platform. The prototype performed admirably, encouraging Earthwerks to quickly refit several of its older models.

## Capabilities

Not exceptionally fast, the *Flea* is ill-suited to a reconnaissance role (compared to modern designs like the *Raven* and the *Tessen*) but is nimble enough for the tighter confines of urban battlefields. Its simple construction allows Earthwerks to produce *Fleas* by the DropShip-load at affordable prices, which in turn gives the company extra profits by selling the 'Mech on open Periphery markets for substantially less than other light 'Mechs.

The *Flea's* design is a favorite among technicians, with critical components situated for easy repair and upgrades. Sales among mercenary units between 3067-68 set profit records for the company, with many of the newer "urban warfare" variants flying off the production lines. Because of the increased demand, Earthwerks recently opened a new assembly line on Victoria.

## Deployment

The FLE-17, produced almost exclusively by Earthwerks for the Confederation until 3053, is rarely seen among any of the other Great Houses' thirty-first century military. However, some 17s have recently appeared on the mercenary markets with Dragoon serial numbers; these sightings lend credibility to the reports of Wannamaker's Widowmakers conducting extensive salvage operations on Outreach and reselling their finds.

A rare variant specifically for use in urban combat was spotted by several mercenary commands on Chaos March worlds (with most sightings on Liberty), though Earthwerks denies such a design. Dubbed the *Fire Ant*, the design seems to have failed whatever testing it was put through, as none have been spotted since 3068.

The newer FLE-19—outfitted as an urban defender—has popped up among many Periphery nations, even as far away as the Rim Collection. An inexpensive design, this is Earthwerks' primary offering to the mercenary market and has begun showing up among many garrison-oriented units.

## Variants

The more common FLE-19 is outfitted with eight of the Confederation's new light machine guns, bundled

in two arrays (a technology recently received from the Concordat). A flamer and a single-use rocket launcher complete the 19's load-out. Buyers are warned by Earthwerks representatives that this variant is not designed to stand up to other BattleMechs unless in a pack formation.

Another new *Flea* variant is rumored to utilize the Confederation's stealth armor technology. The one confirmed report had the 'Mech outfitted with two ER medium lasers and a light PPC, though it is unknown just how the Confederation got its hands on a Combine weapon design. The MechWarrior who logged the report also noted a full squad of Fa Shih riding in support, so it is possible the Confederation is using these long-range *Fleas* as trooper support units.

The mysterious *Fire Ant* variant has several conflicting reports on its exact load-out, though several analysts believe it mounts up to six standard machine guns and three flamers. Because the sightings all revolve around urban centers, it is believed this variant is a light-duty 'Mech built for pacification rather than standard combat. Who built it—and where these 'Mechs have gone—are questions that have yet to be answered.

## Notable MechWarriors

**Brian "Colorado" Bunch:** Kicked out of the Broad Street Bullies for "excessive violence," Bunch arrived on Solaris in 3064 and made quite a name for himself in the Reaches BloodSport circuit. Known as a deadly urban fighter, his preferred ride was a custom-built *Stinger* nicknamed "Cam" that was destroyed during a Word of Blake attack on Equatus in late 3068. Having amassed a considerable sum of money in off-planet accounts (due to his incredible luck with casino dice), Bunch purchased one of the newer FLE-19s smuggled onto the Game World in 3069. Nicknamed "Bruin," his black-and-gold painted *Flea* has attracted a small following among the cutoff warriors of Fitzhugh; Colorado leads his "Band of Nine" from their small headquarters outside of Mantraa. The Band recently made connections with the Solaris Home Defense League and has been passing on intelligence of Blakist operations in the area.



# FLE-17 FLEA

Type: **Flea**

Technology Base: Inner Sphere

Tonnage: 20

Battle Value: 465

## Equipment

		Mass
Internal Structure:	Endo Steel	1
Engine:	120	4
Walking MP:	6	
Running MP:	9 (12)	
Jumping MP:	0	
Heat Sinks:	10	0
Gyro:		2
Cockpit:		3
Armor Factor:	48	3

	Internal Structure	Armor Value
Head	3	5
Center Torso	6	8
Center Torso (rear)		3
R/L Torso	5	5
R/L Torso (rear)		3
R/L Arm	3	4
R/L Leg	4	4

## Weapons and Ammo

	Location	Critical	Tonnage
Medium Pulse Laser	RA	1	2
Medium Pulse Laser	LA	1	2
Flamer	CT	1	1
Small Laser	LT (R)	1	.5
Small Laser	RT (R)	1	.5
MASC	CT	1	1

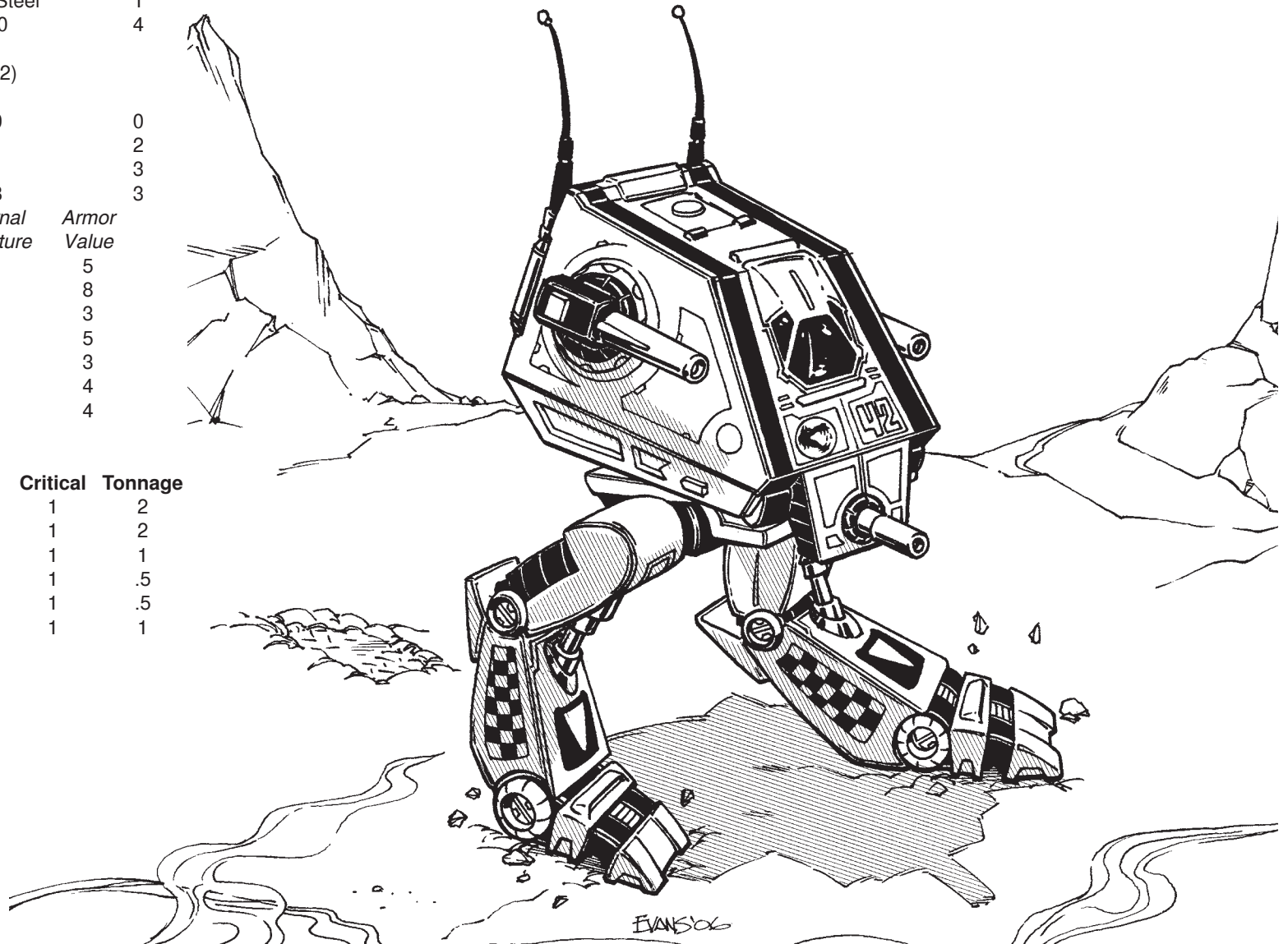

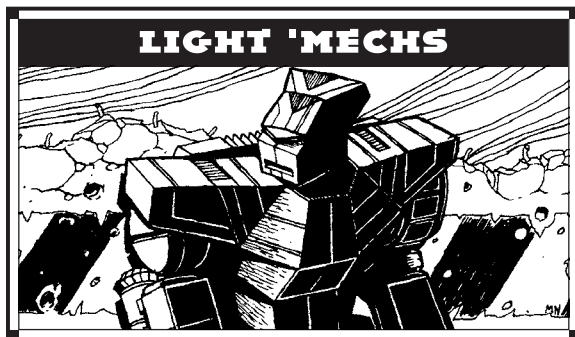

**Mass:** 20 tons

**Chassis:** Corean Model KL-77 Endo Steel

**Power Plant:** Hermes 100

**Cruising Speed:** 54 kph

**Maximum Speed:** 86 kph

**Jump Jets:** Pitban LFT-50

**Jump Capacity:** 90 meters

**Armor:** StarGuard CIV Ferro-Fibrous with CASE

**Armament:**

1 Holly LRM-5 Missile Rack

1 MainFire Point Defense Anti-Missile System

1 Martell Medium Laser

**Manufacturer:** Kallon Weapon Industries

**Primary Factory:** Talon (destroyed 3069)

**Communications System:** Tri-Word Duplex 4880

**Targeting and Tracking System:** Dalban HiRez II

## Overview

Designed for urban reconnaissance, the *Hornet* is lightly armed but relatively heavily armored for its size. First unveiled in 2760, the *Hornet* was met with little interest from the Star League member states, and production was discontinued two years later. Thought lost amidst the chaos of the Succession Wars, production was restarted when Kallon Weapons Industries rediscovered the blueprints in 2990. Again success remained elusive, and it was in the hands of mercenaries that the 'Mech demonstrated its effectiveness during the Fourth Succession War.

Kallon selected the *Hornet* as one of its first 'Mech designs to incorporate recovered technology. Working at the high-security Kallon factory in the Wernke system, the HNT-171 was unveiled in 3051. With the

demand for upgraded BattleMechs to face the Clans, demand for the *Hornet* continued to grow until Capellan forces destroyed the Talon production line in 3069.

## Capabilities

The new version improved on the old HNT-151 in a number of key areas. Incorporating endo-steel construction, ferro-fibrous armor, and cellular ammunition storage equipment, the 171 boasts improved survivability. This is enhanced further by the inclusion of a MainFire Point Defense Anti-Missile System, which provides the *Hornet* with better defense against enemy missiles and has proven a popular feature. The decision to expand the LRM magazine at the expense of jump capability has been less well received, however. Many *Hornet* MechWarriors point out that as one of the lightest 'Mechs on the battlefield, the chance of a *Hornet* actually surviving in a stand-up fight long enough to use all its ammunition is slim. Nonetheless, the large magazine capacity allows the 'Mech to operate effectively as a raider and scout-hunter, and to carry a variety of the new LRM munitions on the market.

The greatest criticism leveled at the 'Mech dates back to the original design and its stubby arms. The *Hornet* fares poorly in close combat due to a lack of hand and lower-arm actuators.

## Deployment

The first upgraded *Hornets* were sent to reinforce the depleted forces in the Sarna March. Facing invading Capellan troops, the *Hornets* of the Third Ceti Hussars worked in pairs to hunt down enemy *Ravens*. Subsequently, both the Ceti Hussars and Deneb Light Cavalry have deployed the 'Mech extensively, teaming it with *Valkyries* and *Wolfhounds*. Both commands included the *Hornet* in their post-FedCom Civil War rebuilding programs.

Federated Suns March Militia regiments have been gradually replacing their aging *Wasps* and *Stingers* with the *Hornet*. The Capellan March Militia has beaten off attacks from Word of Blake raiders by deploying their *Hornets* with a mixed load of Swarm and Thunder munitions. Rapidly deploying Thunder-delivered minefields, Militia troops herd their opponents together and then unleash salvo after salvo of Swarm missiles.

The old HNT-151 found a ready market with mercenary commands, most notably Wolf's Dragoons. The crack mercenaries commissioned their own updated version but later relegated them to service with their Home Guard as increasing quantities of Clantech became available.

## Variants

The original HNT-151 remains in service with militia units throughout the Federated Suns. Lacking advanced technology, it mounts two more jump jets and a small laser in place of the AMS and CASE. Four tons of standard armor provides slightly better protection, but endurance is reduced greatly with only half the LRM magazine capacity.

Wolf's Dragoons initially deployed the *Hornet* in greater numbers than House Davion. After Kallon modified the design, the Dragoons commissioned the production of the HNT-161. A less ambitious upgrade, the 161 retains the small laser and jump capability of the original design by sacrificing the anti-missile system upgrade.

## Notable MechWarriors

**Captain Piet Nichols:** As a young lieutenant in Gamma Regiment of Wolf's Dragoons, Nichols disobeyed orders and led an ill-conceived attack against a Marik supply depot. The attack failed, and two of his MechWarriors were killed before support could arrive. Court-martialed and stripped of his rank, Nichols was "volunteered" to serve under Captain Natasha Kerensky in her newly formed Black Widow Company in 3014.

Wounded seven times while having three BattleMechs shot out from under him, Nichols eventually expunged the disgrace from his record during the Fourth Succession War. Regaining his former rank, Piet commanded a lance from the cockpit of a diminutive *Hornet* for almost thirty years, first in the Black Widow Battalion, then in the Wolf Spiders Battalion.

Retiring from frontline duty, Nichols accepted a company command in the Home Guard in 3060. He was killed during the street fighting in Harlech on the Dragoon's homeworld of Outreach when the Tiger Sharks mercenary battalion overran his company's position.

# HNT-171 HORNET

Type: **Hornet**

Technology Base: Inner Sphere

Tonnage: 20

Battle Value: 535

## Equipment

		Mass
Internal Structure:	Endo Steel	1
Engine:	100	3
Walking MP:	5	
Running MP:	8	
Jumping MP:	3	
Heat Sinks:	10	0
Gyro:		1
Cockpit:		3
Armor Factor:	62	3.5

	Internal Structure	Armor Value
Head	3	7
Center Torso	6	8
Center Torso (rear)		3
R/L Torso	5	8
R/L Torso (rear)		2
R/L Arm	3	6
R/L Leg	4	6

## Weapons and Ammo

	Location	Critical	Tonnage
LRM 5	RT	1	2
Ammo (LRM) 48	LT	2	2
AMS	H	1	.5
Ammo (AMS) 12	LT	1	1
CASE	LT	1	.5
Medium Laser	RA	1	1
Jump Jet	CT	1	.5
Jump Jet	LT	1	.5
Jump Jet	RT	1	.5

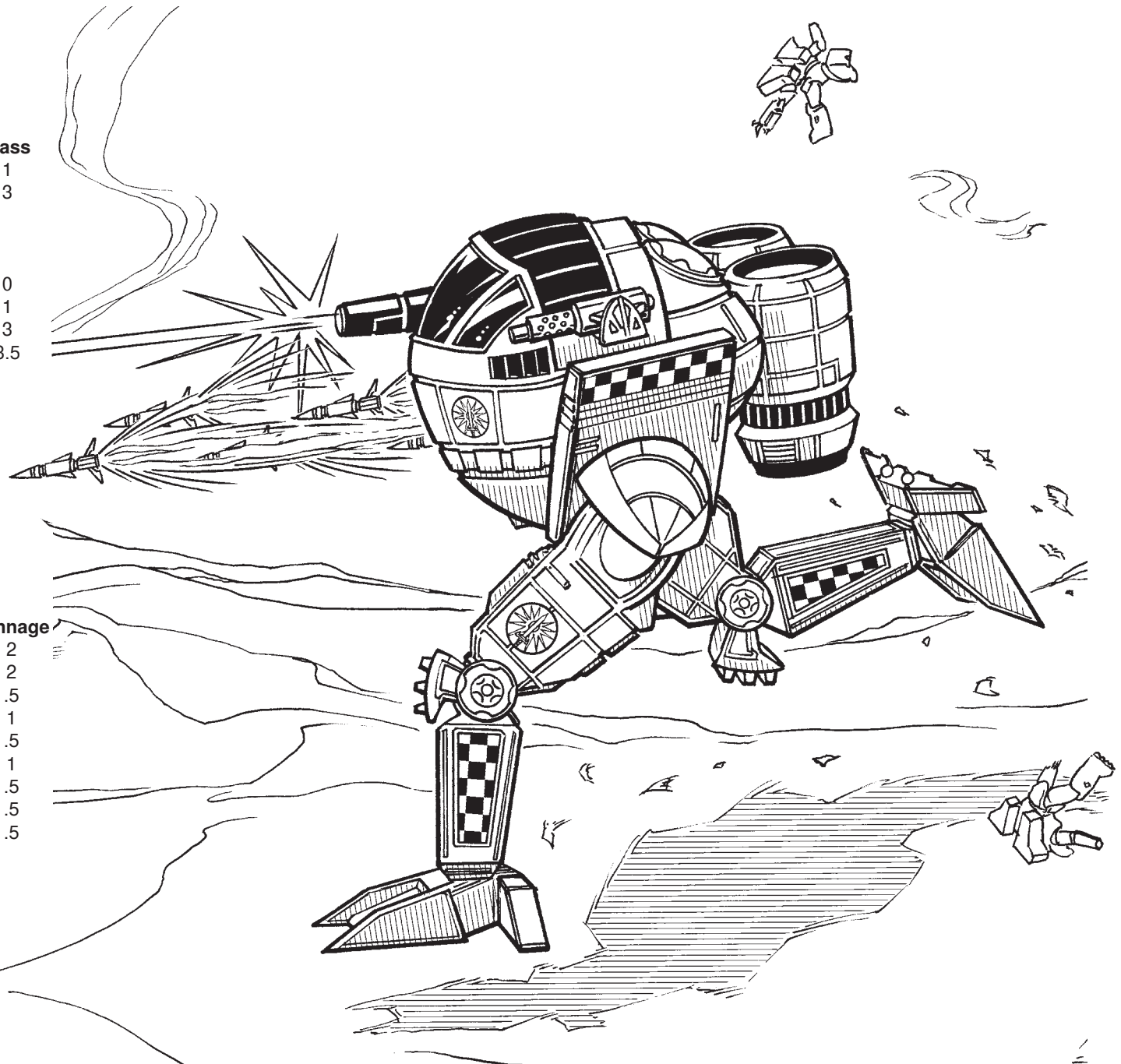

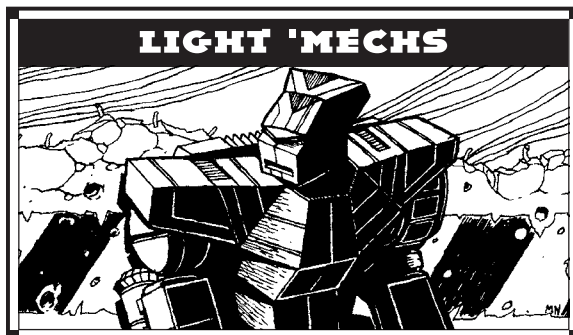

**Mass:** 25 tons

**Chassis:** Foundation Ultralight Endo Steel

**Power Plant:** GM 150

**Cruising Speed:** 64 kph

**Maximum Speed:** 97 kph

**Jump Jets:** None

**Jump Capacity:** None

**Armor:** Lexington Ltd. High Grade Ferro-Fibrous with CASE

**Armament:**

1 Coventry 90 mm SRM-6 Missile Rack

1 Coventry T4H Streak SRM Missile Rack

1 Defiance B3M Medium Laser

**Manufacturer:** Coventry Metal Works

**Primary Factory:** Coventry

**Communications System:** Cyclops 14

**Targeting and Tracking System:** Cyclops Multi-Tasker 10 with Artemis IV System

## Overview

Though the Lyrans are generally known for their penchant for heavier designs, one of the first BattleMechs ever produced by House Steiner was the light-weight *Commando*. The prototype COM-1A *Commando* was tested by the Coventry Defense Conglomerate (later known as Coventry Metal Works) in 2463. Three years later, the COM-2D entered standard production, providing the Lyrans' nascent BattleMech forces with a speedy alternative to the hulking monstrosities of the day. Since then, the *Commando* has seen its share of refits, with the technological booms of the 3030s and the post-Clan eras updating this venerable design to meet the challenges of the modern battlefield.

## Capabilities

The *Commando* balances armor, speed, and firepower in a fashion more common to BattleMechs twice its mass. Achieving speeds of almost 100 kph, its impressive medium-range firepower focuses on a low-heat combination of SRMs and a medium laser. This balance makes this 'Mech ideal for strike operations in built-up terrain. The numerous variants and upgrades that have evolved have continued to focus on this primary mission.

## Deployment

Despite a production span stretching back before the time of the original Star League, the *Commando* has remained a distinctly Lyran design, with the few lines produced beyond Coventry appearing in the Periphery realms of the Taurian Concordat (where the COM-2D is still made by Vandenberg Mechanized Industries of Illiushin) and the Marian Hegemony (who produce the COM-4H model). Even the Lyrans' former FedCom allies in the Federated Suns do not produce these machines for themselves, leaving the bulk of today's *Commandos* in Lyran hands.

## Variants

The original *Commando*, the COM-1A, never achieved full production and sported primitive design standards akin to those found in the Hegemony's first BattleMech, the *Mackie*. However, during the Succession Wars, Lyran engineers experimented with bringing back the original concept of the 1A in the form of the short-lived COM-1B model, which featured the COM-2D's proven chassis design but swapped the right arm SRM-4 with a large laser and downgraded the 2D's center torso SRM-6 to a smaller SRM-2. This variant saw little use, however, as Lyran commanders came to favor the COM-3A instead, with its twin SRM-6s and flamer-medium laser combo—despite the armor protection traded for this firepower.

The technological recovery of the last century allowed for the debut of the revamped COM-5S, which was deployed during the peak years of the Federated Commonwealth. The break-up of that alliance also saw the birth of the light-engine-equipped 7S model, a 5S enhancement that packed two Streak SRM-2s in the

right arm, an Artemis-enhanced SRM-4 in the center torso, and twin ER medium lasers in the left arm, all cooled by double heat sinks. At almost the same time, the Marian Hegemony debuted its own variant, the so-called COM-4H, which upgrades the older 2D model by replacing its weapons load with twin medium lasers on the left arm and double 15-racks of rocket launchers in the right arm and both side torsos.

Since capturing the CMW plant in 3068, Word of Blake engineers have tweaked the COM-7S design further to produce their COM-7B model. This variant replaces the SRM launchers and Artemis systems with a pair of standard SRM-4s, trades one ER medium laser for a pair of flammers, and uses a small cockpit. The freed tonnage allowed this model to add four jump jets and improve its armor, granting the *Commando* greater mobility and durability than ever, while providing an ideal platform for hunting the remnant Lyran forces and the Bradford family, whose resistance continues to defy the Blakist occupation of Coventry even today.

## Notable MechWarriors

**Hauptmann Larry Schuester:** On detached duty from the Twenty-fourth Lyran Guards, Schuester was on Coventry assisting in the training of the recovering Coventry CPM when the Word of Blake struck in 3068. Shot out of two heavier 'Mechs during the initial battle, Schuester found himself at the helm of a recovered COM-7S (which he nicknamed "*Gloria*") by late 3069 and has since led numerous reconnaissance raids at the head of his resistance company, Schuester's Sunday Soldiers. He was last heard from in late 3071, when he led his Soldiers on a daring operation against a Blakist POW camp near the ruins of Port Lawrence.

**Komandant Bono Duganmare:** Not a flashy hero, *Komandant* Duganmare served with the Twenty-second Skye Rangers where he was given the unenviable task of licking new recruits into shape. His success earned him and his "*Death's Knell*" a transfer to the prestigious Nagelring on Tharkad to head up the light BattleMech training program following the Fourth Succession War.

# COM-5S COMMANDO

Type: **Commando**

Technology Base: Inner Sphere

Tonnage: 25

Battle Value: 557

## Equipment

	Endo Steel	Mass
Internal Structure:		1.5
Engine:	150	5.5
Walking MP:	6	
Running MP:	9	
Jumping MP:	0	
Heat Sinks:	10	0
Gyro:		2
Cockpit:		3
Armor Factor:	53	3

	Internal Structure	Armor Value
Head	3	5
Center Torso	8	8
Center Torso (rear)		2
R/L Torso	6	6
R/L Torso (rear)		2
R/L Arm	4	5
R/L Leg	6	6

## Weapons and Ammo

	Location	Critical	Tonnage
SRM 6	LT	2	3
Ammo (SRM) 30	RT	2	2
Artemis IV FCS	LT	1	1
Streak SRM 2	RA	1	1.5
Ammo (Streak) 50	RT	1	1
CASE	RT	1	.5
Medium Laser	LA	1	1

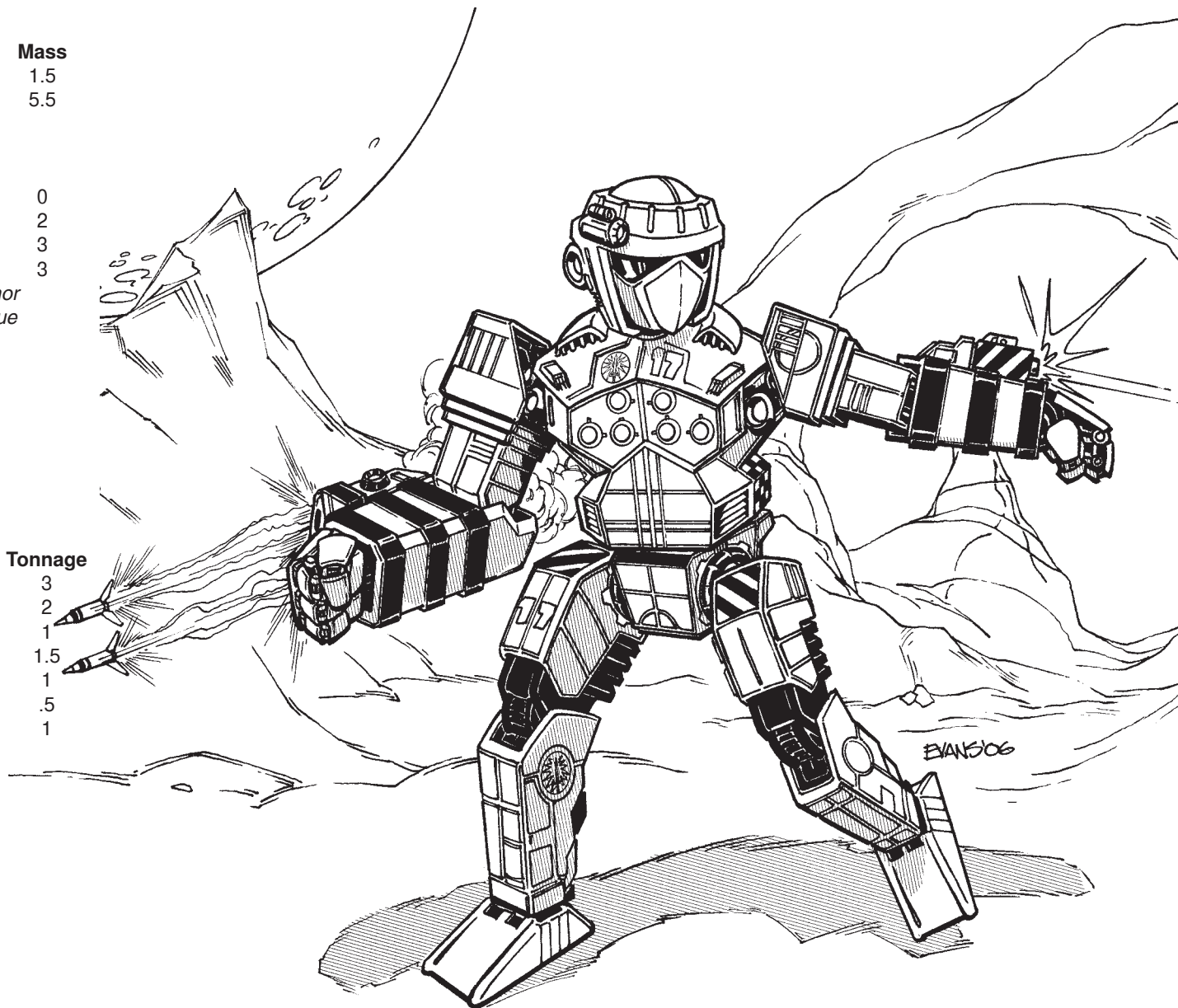

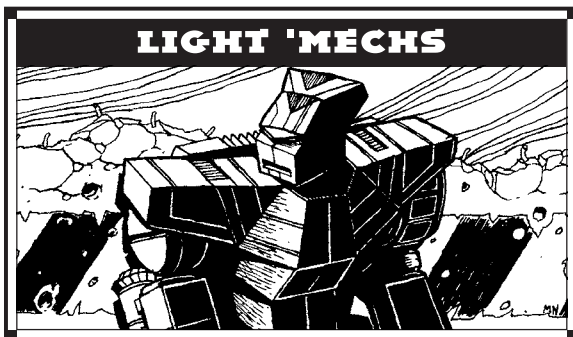

**Mass:** 30 tons

**Chassis:** Duralyte 296

**Power Plant:** GM 180

**Cruising Speed:** 64 kph

**Maximum Speed:** 97 kph

**Jump Jets:** PRS-60

**Jump Capacity:** 150 meters

**Armor:** StarGuard Type II

**Armament:**

1 Magna 400P Medium Pulse Laser

2 Omnicron 1000 Small Lasers

1 SureFire 444 Anti-Missile System

**Manufacturer:** Blackwell Industries

**Primary Factory:** Outreach

**Communications System:** Garret T20C

**Targeting and Tracking System:** Dynatec 150A

## Overview

In early 3060, the Wolf Dragoons arranged a deal with Blackwell Industries to begin general production of several designs for exclusive use by the Dragoons. This manufacturing contract was intended to replace dwindling numbers of rare designs that the Dragoons had brought with them to the Inner Sphere in 3005. Though the FLC-4P *Falcon* originally began life as a field upgrade of existing *Falcons*, it became the first of several BattleMechs built under the Blackwell contract.

## Capabilities

With a maximum speed of 97 kph and a jump capability of 150 meters, the *Falcon* was fast by the standards of 3005, but even the updated FLC-4P is now

consistently outclassed by the more technologically advanced designs of the current era. However, unlike its modern competitors, the *Falcon* does not carry a fragile light or extra-light fusion engine to free up weight for more armament.

The 4P model traded out the original *Falcon's* medium laser for a more accurate medium pulse laser. Also, to compensate for the increasing vulnerability of the *Falcon's* ground speed, the original pair of anti-infantry Reginald Mk. VI machine guns were replaced with a Surefire anti-missile system. A pair of Omnicron 1000 small lasers rounds out the *Falcon's* weaponry. However, that weapons array and the *Falcon's* speed profile are comparable to those of older BattleMech designs ten tons lighter than the *Falcon*. Only the anti-missile system and the six tons of StarGuard armor set the *Falcon* apart from its lighter cousins like the WSP-1A *Wasp*, as it can endure a much heavier beating and remain mission-effective.

## Deployment

While Blackwell was bound by an exclusivity clause on the FLC-4P, the company manufactured the -5P variant to break into the light BattleMech market. The inexpensive and relatively capable -5P variant was sold to all interested parties and proved popular with budget-challenged mercenary units, allowing them to upgrade their forces without spending hefty amounts of cash on fragile extra-light engines or lightweight, advanced chasses. Ironically, many of these *Falcons* were bought by TempTown mercenary units that joined Colonel Waco in the destruction of Harlech.

The Battle of Harlech did not inhibit *Falcon* production or sales from Blackwell's Outreach facility, but the Blakist reprisal for the Dragoon assault on Mars did so with prejudice—Blackwell Industries' Outreach facility was shattered during the sustained Blakist orbital bombardment. Rumors are circulating that the Word of Blake has rebuilt part of the Blackwell facility and is producing various 'Mechs including *Falcons*, but these claims have not been confirmed. The basic *Falcon* was produced in sufficient numbers that "new" sightings may simply be of 'Mechs built prior to the Word of Blake's second attack on Outreach.

## Variants

In addition to the -4P model, Blackwell Industries manufactured two variants, one for the general military market and one exclusively for Wolf's Dragoons. The first was a general upgrade of the *Falcon* to the latest technology released in 3065. This model, known as the -5P, carries a medium pulse laser and a pair of extended-range medium lasers slaved to a targeting computer. The anti-missile system was eliminated and the engine replaced with a light version to make room for the MASC system so the *Falcon* now had a chance to pace the swifter, modern BattleMechs in its weight class.

The second version utilized Clan technology, though it retained the chassis of the -4P model. Used exclusively by Wolf's Dragoons, the -6C replaces the twelve standard heat sinks with ten double strength units and upgrades all weaponry to Clan models. These potent weapons are slaved to a targeting computer. The medium pulse laser was replaced with an ER large laser while the standard small lasers were changed to extended-range versions. The standard armor was replaced with ferro-fibrous to enhance the unit's survivability. Unfortunately, only a handful of these variants survived the battle on Outreach, and most of these are now in the hands of Blakist forces.

## Notable Pilots

**Lieutenant Elton Rice:** Elton Rice was an independent MechWarrior hired to serve with Waco at the Battle of Harlech. His prior experience in the AFFC led him to command a heavy lance of five other independent MechWarriors. While Rice and his lance had no trouble taking a contract to battle Dragoons, they later balked at the extremes some of the rampaging TempTown MechWarriors took. Rice and his lance abandoned their contract against the Dragoons, instead successfully defending several thousand civilians sheltered in a large office building. The effort cost Rice's lance all of their BattleMechs and several of their lives.

# FLC-4P FALCON

Type: **Falcon**

Technology Base: Inner Sphere

Tonnage: 30

Battle Value: 649

## Equipment

Internal Structure:

Engine: 180

Walking MP: 6

Running MP: 9

Jumping MP: 5

Heat Sinks: 12

Gyro: 2

Cockpit: 3

Armor Factor: 96

Internal Structure	Armor Value
--------------------	-------------

Head	3	9
------	---	---

Center Torso	10	14
--------------	----	----

Center Torso (rear)		3
---------------------	--	---

R/L Torso	7	12
-----------	---	----

R/L Torso (rear)		2
------------------	--	---

R/L Arm	5	8
---------	---	---

R/L Leg	7	13
---------	---	----

## Weapons and Ammo

	Location	Critical	Tonnage
--	----------	----------	---------

Medium Pulse Laser	RA	1	2
--------------------	----	---	---

Small Laser	RA	1	.5
-------------	----	---	----

Small Laser	LA	1	.5
-------------	----	---	----

Anti-Missile System	LT	1	.5
---------------------	----	---	----

Ammo (AMS) 12	RT	1	1
---------------	----	---	---

Jump Jets	RT	2	1
-----------	----	---	---

Jump Jets	LT	2	1
-----------	----	---	---

Jump Jet	CT	1	.5
----------	----	---	----

## Mass

3

7

2

2

3

6

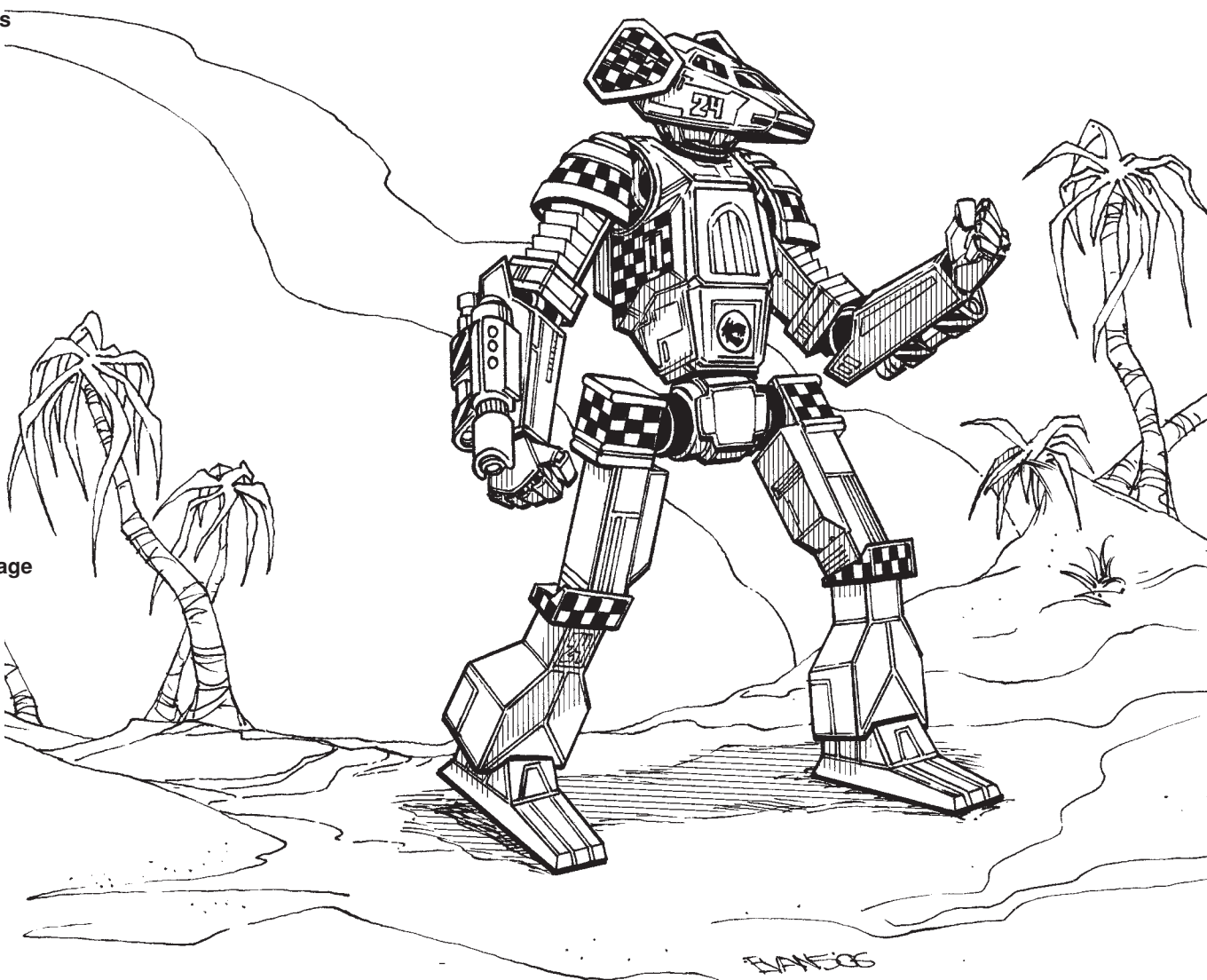

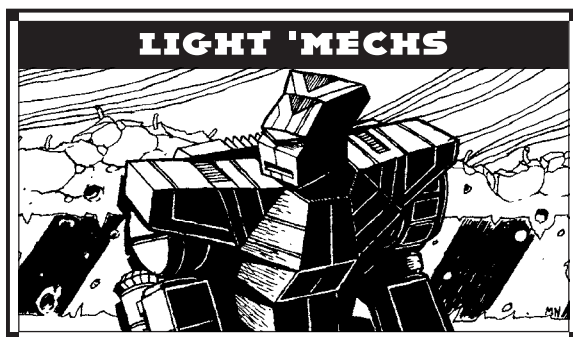

**Mass:** 30 tons

**Chassis:** Earthwerks Firefly

**Power Plant:** GM 150

**Cruising Speed:** 54 kph

**Maximum Speed:** 86 kph

**Jump Jets:** Lexington Lifters

**Jump Capacity:** 120 meters

**Armor:** StarSlab/1 with CASE

**Armament:**

3 Martell Medium Lasers

1 Coventry Five-Tube LRM 5

1 Surefire 444 Anti-missile system

**Manufacturer:** Coventry/Earthwerks Combine

**Primary Factory:** Terra (destroyed 2779)

**Communications System:** Datcom 18

**Targeting and Tracking System:** Radcom TXX

## Overview

Entering service in the late 27th century, the *Firefly* was one of the standard light 'Mechs of the SLDF in its later years. Although slow compared to other 'Mechs of its weight class, it was well armed and armored and often served as the anvil against which other force's recon units were shattered. Examples appeared in all the House militaries, though not in the numbers employed by the SLDF, and save for rumors of odd examples in the Periphery, all were thought destroyed by the end of the Second Succession War.

The reappearance of the design with Wolf's Dragoons in the early 31st century was met with raised eyebrows, though the secret of the *Firefly's* origin was made clear when the Dragoons' Clan origins came to light. The appearance of a small number of *Fireflys*

with the Com Guard forces in the 3040s encountered a similar reaction. [EDITOR'S NOTE: though this design technically belongs in the Star League section of this briefing, its modern association with the Dragoons warrants its inclusion here.]

## Capabilities

A *Firefly* field modification began to appear with Wolf's Dragons in the late 3040s as part of their preparations for the Clan onslaught they knew was coming. Very limited in scope, the upgrade was designed to increase the survivability of the *Firefly* at the expense of firepower. An anti-missile system replaced three of the small lasers of the 4A (strangely, a "false" AMS weapon port appears in the right arm) while cellular ammunition storage took the place of the fourth, guarding against the possibility of catastrophic damage within the AMS ammo store. The LRM ammunition was not similarly protected, however, as it would have required a too-extensive remodeling of the chassis. But even with its reduced firepower, the *Firefly* remains a well armed 'Mech for its class, capable in both close-in and medium-range engagements.

## Deployment

The Dragoons employed the *Firefly* as the backbone of their light 'Mech formations, adding both firepower and resilience. Despite their relatively low-tech systems *Fireflys* performed well on Luthien and in a host of other battles between the Dragoons and the Clans. Their numbers were steadily denuded over the years, however, and by the time clashes erupted on Outreach, scarcely half a dozen 4Bs remained in Dragoon service. Rumors of more advanced models appearing after the destruction of Harlech would seem to confirm the rumors of full-fledged manufacturing of the *Firefly*, though why such advanced models didn't appear sooner is unclear.

All of the invading Clans employ advanced versions of the *Firefly* with their second-line forces.

## Variants

The handful of Com Guard *Fireflys* differ markedly from any of the Dragoon configurations and have received the 4C designation. Known to employ endo-

steel skeletons and extra-light engines, they utilize the freed up space to upgrade their laser weaponry to pulse variants. Double heat sinks allow the ComStar *Fireflys* to use the expanded weaponry efficiently, as was demonstrated against the Clans during Operation Bulldog.

The new Dragoon variants—designated 4D—evolve the upgraded model. Retaining the same form factor as the 4B, these new models employ ferro-fibrous armor and an endo-steel skeleton as well as a light engine, using the mass freed up to upgrade the laser weaponry to extended-range versions and adding an Artemis FCS to the LRM launcher. Unlike the ComStar variant, the 4D does not use advanced heat sinks, but the inclusion of two additional sinks allows the 4D to operate efficiently.

An advanced variant of the *Firefly* employed by the Clans follows a radically different path, employing double heat sinks and endo steel but replacing all the 4A's laser weaponry with ER small lasers and medium pulse lasers. An SRM-2 launcher replaces the 4A's long-range missiles, turning the multi-role Star League model into a light brawler.

## Notable MechWarriors

**Leftenant James Reynolds:** How a malcontent like James "Little Jimmy" Reynolds managed to get his hands on a *Firefly*, let alone an advanced Clan model, is a mystery that has troubled bandit hunters in the periphery for the last decade. Together with his little band of pirates, Reynolds has harassed both the Clans and the Draconis Combine since around 3060 (a date that leads many to suspect Reynolds, or at least his equipment, originates with the fallen Smoke Jaguars). He has managed to elude the best efforts of the DCMS and the Ghost Bears to eradicate the menace. Reynolds has managed to stay one step ahead of those hunting him while simultaneously pursuing his primary goal in life: profit. The Ghost Bears have allegedly found links between Reynolds and one of Clan Diamond Shark's trading facilities, but the mercantile Clan has denied culpability for the pirate's activities, maintaining instead that their trading facilities operate on a good-faith basis.



# FFL-4B FIREFLY

Type: **Firefly**

Technology Base: Inner Sphere

Tonnage: 30 tons

Battle Value: 870

## Equipment

Internal Structure:

Engine: 150

Walking MP: 5

Running MP: 8

Jumping MP: 4

Heat Sinks: 10

Gyro: 2

Cockpit: 3

Armor Factor: 104

Internal Structure	Armor Value
--------------------	-------------

Head	3	8
------	---	---

Center Torso	10	15
--------------	----	----

Center Torso (rear)		5
---------------------	--	---

R/L Torso	7	11
-----------	---	----

R/L Torso (rear)		3
------------------	--	---

R/L Arm	5	10
---------	---	----

R/L Leg	7	14
---------	---	----

## Weapons

### and Ammo

	Location	Critical	Tonnage
--	----------	----------	---------

Medium Laser	CT	1	1
--------------	----	---	---

Medium Laser	LT	1	1
--------------	----	---	---

Medium Laser	RT	1	1
--------------	----	---	---

LRM 5	RT	1	2
-------	----	---	---

Ammo (LRM) 24	LT	1	1
---------------	----	---	---

Anti-missile system	LA	1	.5
---------------------	----	---	----

Ammo (AMS) 12	LT	1	1
---------------	----	---	---

CASE	LT	1	.5
------	----	---	----

Jump Jets	LL	2	1
-----------	----	---	---

Jump Jets	RL	2	1
-----------	----	---	---

## Mass

3

5.5

0

2

3

6.5

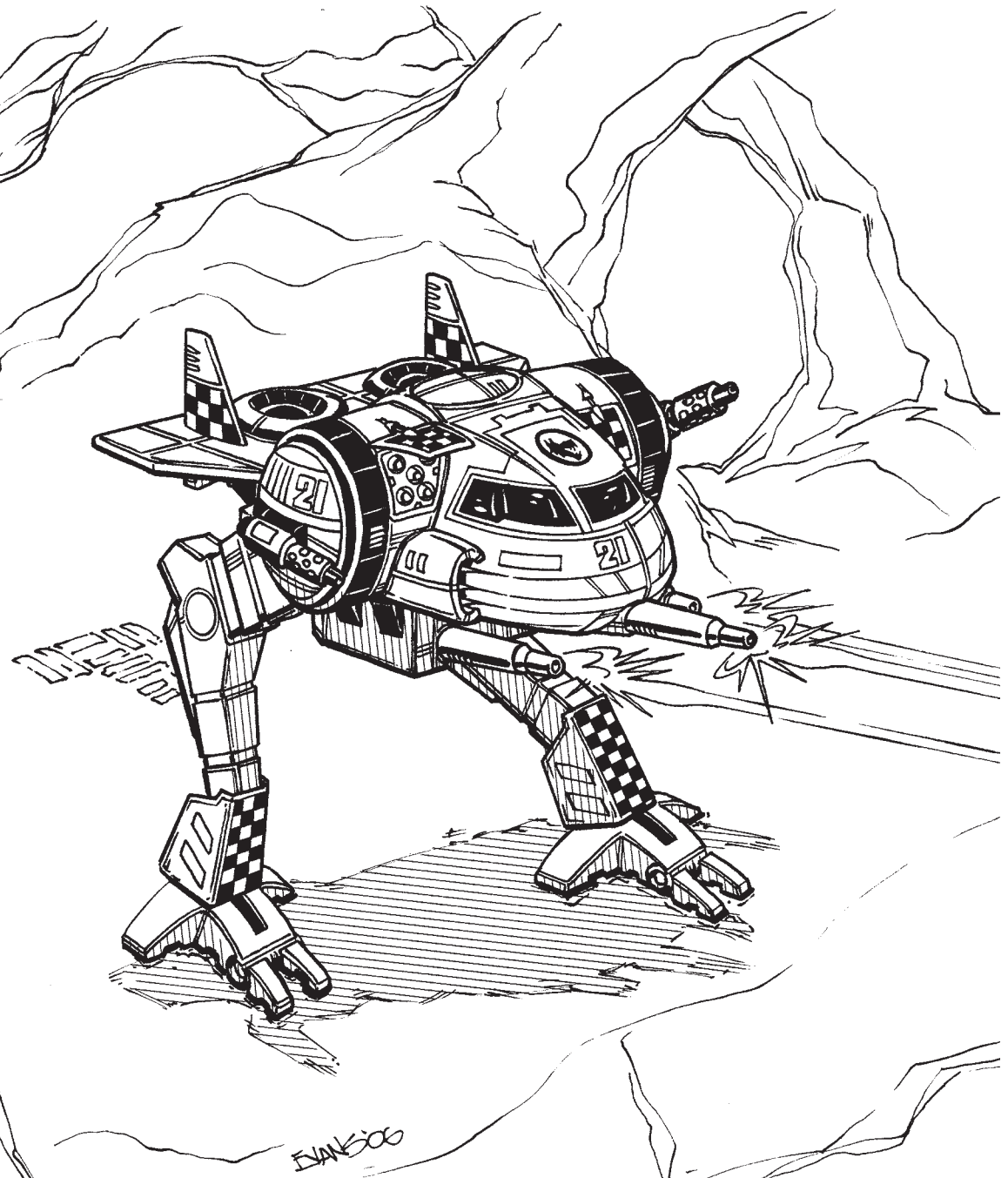

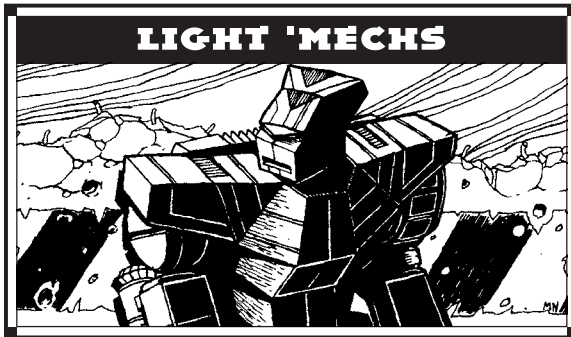

**Mass:** 30 tons

**Chassis:** Duralyte 246

**Power Plant:** GM 180

**Cruising Speed:** 64 kph

**Maximum Speed:** 97 kph

**Jump Jets:** Rawlings 95

**Jump Capacity:** 180 meters

**Armor:** StarGuard I

**Armament:**

1 Arrowlite SRM-6 Missile Rack

2 Hovertec Streak SRM-2 Pods

**Manufacturer:** Jalastar Aerospace

**Primary Factory:** Panpour

**Communications System:** Garret T10B

**Targeting and Tracking System:** Dynatec 128C

## Overview

First produced in the mid-28th century for export to the Star League member-states, the *Javelin* was designed as a scout 'Mech that had enough armor and mobility to survive unexpected encounters while also possessing an offensive punch that could dissuade pursuit. The Federated Suns turned out to be Stormvanger Assemblies' largest *Javelin* customer, incorporating the 'Mech into almost every BattleMech regiment in its armed forces by the beginning of the Succession Wars.

Though Stormvanger Assemblies is centuries gone, destroyed during the Amaris Coup, its *Javelin* remains a presence on today's battlefields thanks to the Armed Forces of the Federated Suns' high regard for the 'Mech. So high, in fact, that Jalastar Aerospace

began new production runs of the 'Mech in 3055 at the behest of the AFFC High Command.

## Capabilities

When compared to other reconnaissance 'Mechs, the *Javelin* is certainly not the fastest or the most mobile, but those qualities were never meant to be its key strengths. From the ground up, the *Javelin* was a compromise between speed and firepower. It's that compromise that has allowed it to serve for so long with such a distinguished history.

Capable of sustained speeds of nearly 100 kph and possessing a 180-meter jump range, this light 'Mech has the mobility needed to carry out its reconnaissance duties and to outmaneuver most heavier BattleMechs or vehicles on the battlefields of yesterday or today. Though it mounts but four tons of conventional StarGuard armor, until recent years that was considered more than enough to survive an ambush or parting fire and still return to one's own lines safely.

The *Javelin* originally mounted a pair of Arrowlite SRM-6 racks, one of which was replaced when the *Javelin* received a facelift during the AFFC BattleMech upgrade program of the late 3040s. As a testament to the 'Mech's abilities, it saw only minor improvements, with two lostech Streak SRM-2 missile systems replacing one of the SRM-6 racks. This made the *Javelin* a more ammunition-efficient design.

## Deployment

*Javelins* have served in every AFFS BattleMech regiment since before the Amaris Civil War. In fact, the 'Mech is virtually synonymous with the Federated Suns' military among MechWarriors throughout the Inner Sphere—it is that numerous.

Typically, the *Javelin* anchors scout lances, though in units like the Davion Light Guards and the First Fed-Suns Armored Cavalry, it is also teamed with other *Javelins* to create highly mobile fire lances.

## Variants

The *Javelin* may be a successful and proven scout 'Mech, but it also has a number of lostech variants that have appeared in the past twenty years. The first is a more dedicated scout that takes more advantage of

lostech developments. Incorporating double-strength heat sinks and ferro-fibrous armor, it drops all the missile racks, replacing them with SRM-4 launchers and mounting a Beagle active probe and a Guardian ECM suite. The second variant, a take on the so-called "*Fire Javelin*," appeared after the Clan War when many *Javelins* required major repairs. Also mounting double heat sinks and ferro-fibrous armor, it replaces the standard weapons load-out with seven medium lasers—typically surplus after completing other 'Mech upgrades—and an additional ton of armor.

The current *Javelin* production models are the JVN-11D and -11F. Redesigned from the ground up with a lighter endo-steel chassis and extralight fusion engine, these new *Javelins* can carry eleven full tons of payload. The -11D ties three ER medium lasers and a pair of medium pulse lasers to a NAIS-developed targeting computer and Wunderland C<sup>3</sup> slave module. The recently fielded -11F is a technology demonstrator, mounting a captured Combine snub-nosed PPC and two triple-machinegun arrays. Both are close assault designs, but only the -11D exists in any quantity within the AFFS.

## Notable MechWarriors

**Sergeant-Major Riko Li:** MechWarrior Riko Li was a down-on-his-luck mercenary that found his way into the perpetually down-on-its-luck Wilson's Hussars when the Word of Blake struck Fletcher in preparation for the Jihad. Somehow, the mercenaries survived the bloodbath, and afterward Li was offered a billet in the Eighth Syrtis Fusiliers—where he and his "*Okey-Dokey*" have served since.

**Timothy "Tito" Brenn:** Once an AFFC lieutenant, "Tito" Brenn went AWOL with his *Javelin* when Operation Guererro transformed the Sarna March into the Chaos March. For nearly fifteen years, he has himself out as bodyguard and extra muscle for any petty baron that could pay. He ultimately landed in the Calderon Protectorate where he's served as a company commander in the Second Taurian Pride for the past four years.

# JVN-10P JAVELIN

Type: **Javelin**

Technology Base: Inner Sphere

Tonnage: 30

Battle Value: 590

## Equipment

Internal Structure:

Engine: 180

Walking MP: 6

Running MP: 9

Jumping MP: 6

Heat Sinks: 10

Gyro: 2

Cockpit: 3

Armor Factor: 64

Internal Structure	Armor Value
--------------------	-------------

Head	3	6
------	---	---

Center Torso	10	8
--------------	----	---

Center Torso (rear)		2
---------------------	--	---

R/L Torso	7	8
-----------	---	---

R/L Torso (rear)		2
------------------	--	---

R/L Arm	5	6
---------	---	---

R/L Leg	7	8
---------	---	---

## Mass

3

7

0

2

3

4

## Weapons

### And Ammo

	Location	Critical	Tonnage
--	----------	----------	---------

SRM 6	RT	2	3
-------	----	---	---

Ammo (SRM) 15	RT	1	1
---------------	----	---	---

2 Streak SRM 2	LT	2	3
----------------	----	---	---

Ammo (Streak) 50	LT	1	1
------------------	----	---	---

Jump Jets	CT	2	1
-----------	----	---	---

Jump Jets	RL	2	1
-----------	----	---	---

Jump Jets	LL	2	1
-----------	----	---	---



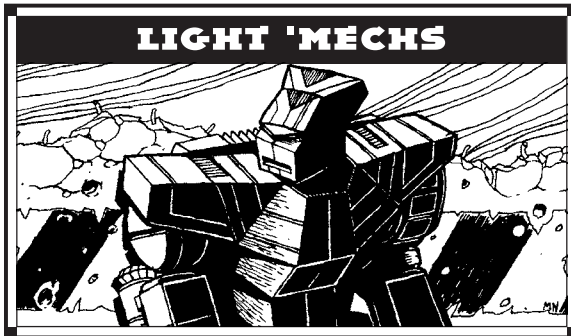

**Mass:** 30 tons

**Chassis:** Crucis-II Deluxe Endo Steel

**Power Plant:** Pitban 240

**Cruising Speed:** 86 kph

**Maximum Speed:** 129 kph

**Jump Jets:** Rawlings 75

**Jump Capacity:** 240 meters

**Armor:** Kallon FWL Special Ferro-Fibrous

**Armament:**

2 Tronel XII Medium Pulse Lasers

**Manufacturer:** Nimakachi Fusion Products Limited

**Primary Factory:** Tematagi (destroyed 3069),  
Lapida II

**Communications System:** Omicron 4002

Networking Channel

**Targeting and Tracking System:** TRSS Eagle Eye

## Overview

Designed by Newhart Interstellar Industries for use by SLDF Special Operations units (such as the Blackhearts), the *Spider's* blueprints were among those recovered from the crumbling Terran Hegemony by the Free Worlds League. With the FWLM suffering heavy losses on both the Capellan and Lyran fronts, Nimakachi Fusion Products was charged by the League Parliament to produce the *Spider* in return for exclusive rights to the technical data. Like other manufacturers, Nimakachi upgraded their design with recovered technology. While the Free Worlds League expressed little interest in an updated version, Nimakachi found a ready market exporting to other Inner Sphere powers, especially the Draconis Combine. Nimakachi's Lapida II plant produces its

signature 'Mech under contract to the DCMS, while also manufacturing the *Venom* and *Bishamon*.

## Capabilities

The new SDR-7M *Spider* incorporates an endo-steel internal structure and ferro-fibrous armor to provide comparable protection for less weight. This upgrade has allowed Nimakachi to replace the original medium lasers with Tronel XII medium pulse lasers. Accurate but short-ranged, this new weapons array requires the MechWarrior to use the *Spider's* speed and agility to close to point-blank range.

One thing Nimakachi did not upgrade was the *Spider's* cramped cockpit. Lacking space to mount an ejection system, a MechWarrior must exit the 'Mech under their own power in an emergency.

## Deployment

Woefully short of light BattleMech production capacity in the face of the Clan threat, House Kurita frantically expanded its remaining production facilities and looked beyond its borders for the weapons it required to rebuild and upgrade the DCMS. Fortunately for the DCMS, Nimakachi was able to help in both regards thanks to its locally produced designs and its ability to import 'Mechs directly from its FWL factories. The DCMS has deployed their domestic and Marik-built *Spiders* alongside homegrown designs such as the *Jenner*, *Hitman*, and *Kabuto*.

Preparing for their bid to seize control of Terra in 3058, the Word of Blake purchased several *Spiders* to bolster their forces. Many of these have subsequently found their way into the ranks of mercenary commands serving the Blakists in their expanding Protectorate.

## Variants

The DCMS has modified several of their *Spiders* to operate as part of a C<sup>3</sup> network. The SDR-C replaces one pulse laser with a standard medium laser and adds a C<sup>3</sup> slave unit.

The few SDR-7Ms purchased by the FWLM have been modified in the field. Designated the SDR-8M, this version upgrades the heat sinks to double efficiency models.

In 3067 Nimakachi announced plans to restyle the *Spider*—doubtless inspired by the success other manufacturers have enjoyed with revised versions of classic designs. The SDR-7K employs a light engine and mounts double heat sinks while increasing armor protection to over five tons. Crucially, the redesign has allowed Nimakachi engineers to modify the cockpit to incorporate an ejection system.

A variant of the SDR-7K, the SDR-7K2, carries only five tons of armor, and jump capability has been reduced to 210 meters. Armed with a Diverse Optics Sunbeam extended-range large laser, this version is clearly intended to serve as a scout hunter.

A further variant of the 7K—dubbed the 7KC—appeared in 3070 after the destruction of Nimakachi's Tematagi facility. By dropping the pulse lasers, this model has enough space to mount both a light PPC and C<sup>3</sup> slave unit.

Nimakachi also used the *Spider* as the basis for their heavier *Venom* BattleMech.

## Notable MechWarriors

**Lieutenant Fargo Hambelton:** A twenty-year veteran, Hambelton serves as lead scout in the Second Battalion of the Hsien Hotheads. When Brenn Twohy seized control of his ancestral homeworld of Hsien in 3067, Hambelton and his scout lance were instrumental in running Gael's Grinders to ground.

While not the best of shots, Hambelton's ability to pass on his years of experience proved invaluable in the Hotheads' current assignment to train the newly formed Word of Blake Protectorate Militia. When informed that he (and the rest of the Hotheads) had been branded as rogues for their support of the Word of Blake, Hambelton noted (with typical pragmatism) that all he is doing is collecting his paycheck.

**Chu-i Niko Vester:** Generally regarded as one of the best light 'Mech pilots in the DCMS, Vester was one of the few to survive the destruction of the Ninth Pesht Regulars in the initial waves of the Clan invasion in 3050. Escaping the Smoke Jaguar onslaught, Vester was reassigned to the Fourth Pesht Regulars. Equipped with an FWL-manufactured *Spider*, he later gave a virtuoso performance against the Second Bear Regulars on Kiamba.

# SDR-7M SPIDER

Type: **Spider**

Technology Base: Inner Sphere

Tonnage: 30

Battle Value: 621

## Equipment

		Mass
Internal Structure:	Endo Steel	1.5
Engine:	240	11.5
Walking MP:	8	
Running MP:	12	
Jumping MP:	8	
Heat Sinks:	10	0
Gyro:		3
Cockpit:		3
Armor Factor:	53	3

	Internal Structure	Armor Value
Head	3	6
Center Torso	10	8
Center Torso (rear)		3
R/L Torso	7	6
R/L Torso (rear)		2
R/L Arm	5	5
R/L Leg	7	5

## Weapons and Ammo

	Location	Critical	Tonnage
2 Medium Pulse Lasers	CT	2	4
Jump Jets	LT	4	2
Jump Jets	RT	4	2

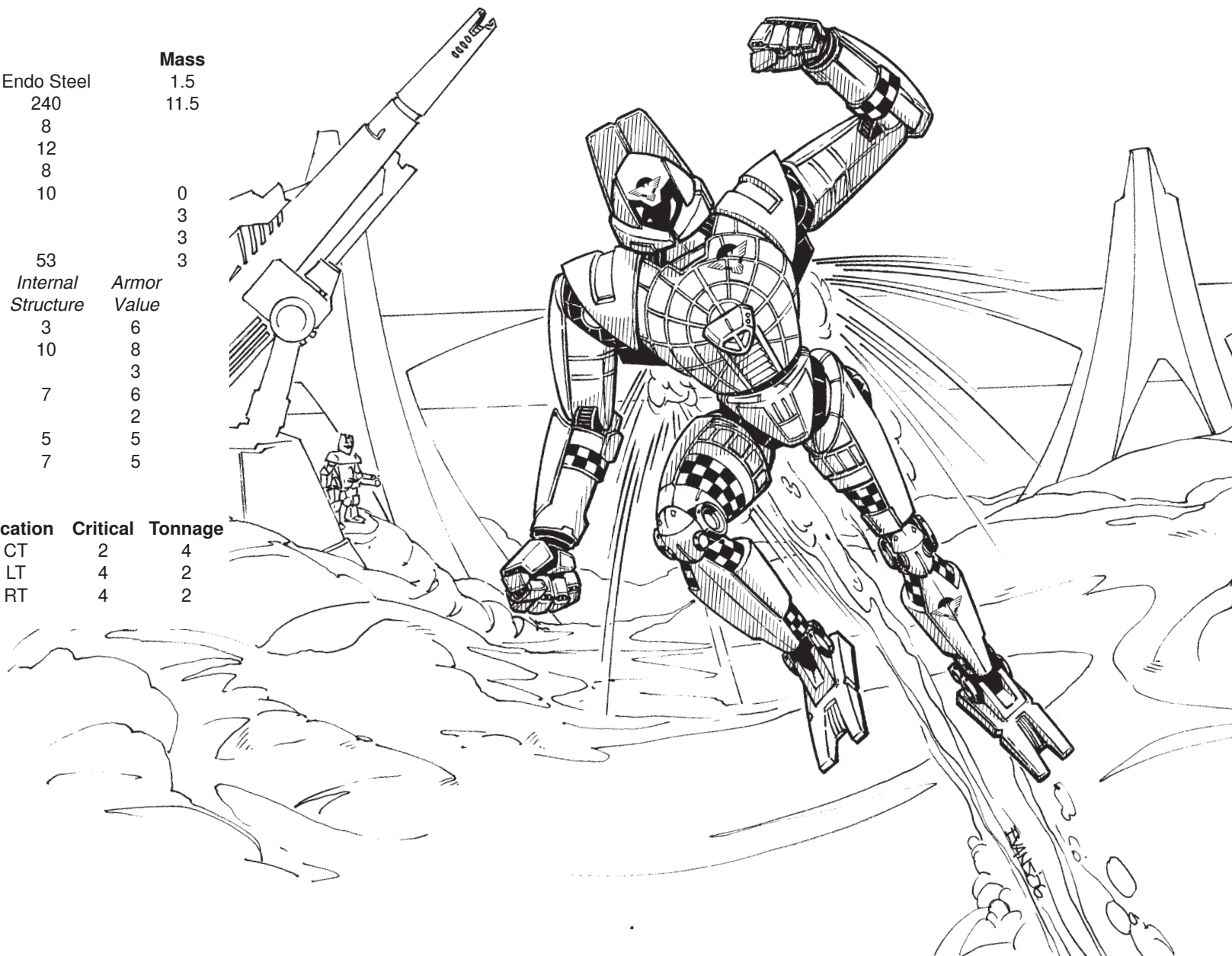

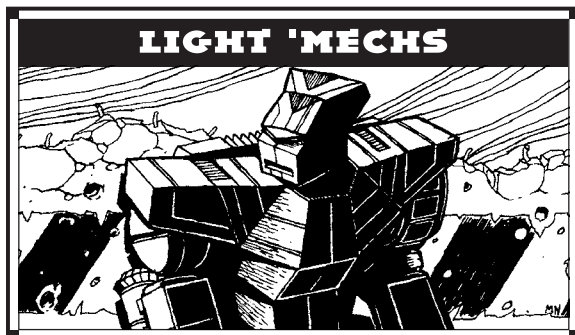

**Mass:** 30 tons  
**Chassis:** Republic-R  
**Power Plant:** Leenex 60  
**Cruising Speed:** 21 kph  
**Maximum Speed:** 32 kph  
**Jump Jets:** Pitban 6000  
**Jump Capacity:** 60 meters  
**Armor:** Durallex Medium  
**Armament:**  
1 Mydron Excel LB 10-X Autocannon  
1 Magna 200P Small Pulse Laser  
1 Harmon Small Laser  
**Manufacturer:** Orguss Industries  
**Primary Factory:** Marcus (destroyed 2837)  
**Communications System:** Dalban Interact  
**Targeting and Tracking System:** Dalban Urban

## Overview

Created to defend the cities of the Star League, the Successor States reserved the humble *UrbanMech* for garrison duty. Thus, unlike many contemporary designs, it was spared the carnage of the Succession Wars. Even after the destruction of Orguss Industries, large numbers of *UrbanMechs* remain in service. Often the light 'Mech languishes at the bottom of the list for upgrades, but in the Capellan Confederation the CCAF was working desperately to update the few BattleMechs that survived the disastrous Fourth Succession War. Here even the lowly *UrbanMech* has received an infusion of advanced technology.

## Capabilities

The standard Capellan field modification kit replaces the Emperor-B autocannon with a Mydron

Excel LB 10-X, enhancing the *UrbanMech's* effective range and accuracy. This lighter weapon allows for the addition of a Magna 200P small pulse laser for infantry suppression. Both these changes further enhance the *UrbanMech's* capabilities in its role as an urban combatant. However, the design's underlying deficiency—a painfully low speed—has not been addressed.

While operating in an urban environment, the *UrbanMech* can usually be expected to give a good account of itself even when facing medium and heavy BattleMechs. Open country is another story—only a foolish or desperate commander will deploy the 'Mech for offensive operations in those locales.

## Deployment

The bulk of the Confederation's *UrbanMechs* are deployed with the Confederation Reserve Cavalry and the Capellan Defense Force. The St. Ives Lancers also boasts a number of *UrbanMechs*, which have been concentrated into specialized urban combat units.

Elsewhere in the Inner Sphere, the *UrbanMech* is usually relegated to militia formations. The Federated Suns Capellan March Militia fields the highest concentration of the design outside of Liao space, since the unit is composed mostly of captured Capellan equipment.

## Variants

Other realms are evaluating different modifications, but none have resolved the *UrbanMech's* lack of speed. Though the technology to add a lighter engine has become more widespread, such a modification goes far beyond a simple field refit. Even the Capellan Confederation has shied away from investing the resources necessary to perform such an upgrade. Consequently, current field modifications have confined themselves to tinkering with the weapons systems and armor.

House Kurita's field modification kits have done away with the autocannon altogether. Instead, the UM-68 mounts a Shigunga MRM-30 launcher and two tons of ammunition. The extra punch provided by the new armament came as a nasty surprise to Clan Ghost Bear warriors when they first encountered it.

The Free Worlds League utilizes a class 10 Mydron Excel Ultra autocannon on their upgraded UM-69. Though it mounts only ten single heat sinks, heat levels are rarely a problem. On the other hand, the

Ultra autocannon's voracious appetite can empty the ten-round magazine at an alarming rate. Even upgrading the small laser to an ER model does little to offset the loss of firepower when the autocannon's paltry ammunition supply runs out. This mode also replaces the Durallex armor with five tons of Kallon FWL Special ferro-fibrous armor.

Found predominantly in the Federated Suns' Capellan March, the UM-70 replaces the Emperor-B with a Mydron Tornado RAC/5 and two tons of ammunition. Instead of a small pulse laser, the UM-70 mounts an extended-range medium laser. The arm-mounted small laser is upgraded to an extended-range version, and the armor is upgraded with ferro-fibrous material.

## Notable MechWarriors

**Lieutenant Paul Wellseley:** Grandson of the famous Patricia Wellseley, Paul has followed in his esteemed grandmother's footsteps and served with the St. Ives Armored Cavalry. Piloting his grandmother's 'Mech, Paul soon eclipsed her formidable combat record as he fought against the CCAF and their Periphery allies as they devoured his beloved St. Ives Compact. Following St. Ives formal surrender, Wellseley and his *UrbanMech* were incorporated into the Second St. Ives Lancers as the command rebuilt.

Though bound to do his duty and fight for the Confederation, Wellseley remains deeply suspicious of the Confederation leadership on Sian. Though appearing sane (especially in comparison to his predecessors), Sun-Tzu Liao has exhibited an indifference to Capellan civilian casualties that Wellseley finds deeply disturbing.

**Ringo Peterson:** After winning his beloved "*Bessie*" in a poker game on Tortuga in 3060, Peterson embarked on a career of banditry. A successful campaign of larceny on the Periphery world of Randall's Regret provided Peterson with the funds needed to upgrade his *UrbanMech*.

With *Bessie's* improved firepower, Peterson executed the infamous Hoonar Bank Heist in 3071 and spent the next six months celebrating on Herotitus. Peterson and his 'Mech subsequently have disappeared amidst a flurry of conflicting rumors.

# UM-R63 URBANMECH

Type: **UrbanMech**

Technology Base: Inner Sphere

Tonnage: 30

Battle Value: 540

## Equipment

Internal Structure:

Engine:

Walking MP:

Running MP:

Jumping MP:

Heat Sinks:

Gyro:

Cockpit:

Armor Factor:

## Mass

3

1.5

60

2

3

2

11

1

1

3

6

Internal  
Structure

Armor  
Value

Head

3

9

Center Torso

10

11

Center Torso (rear)

8

R/L Torso

7

8

R/L Torso (rear)

4

R/L Arm

5

10

R/L Leg

7

12

## Weapons

### and Ammo

LB 10-X AC

Location

Critical

Tonnage

RA

6

11

Ammo (LB-X) 10

RT

1

1

Small Pulse Laser

LT

1

1

Small Laser

LA

1

.5

Jump Jets

CT

2

1

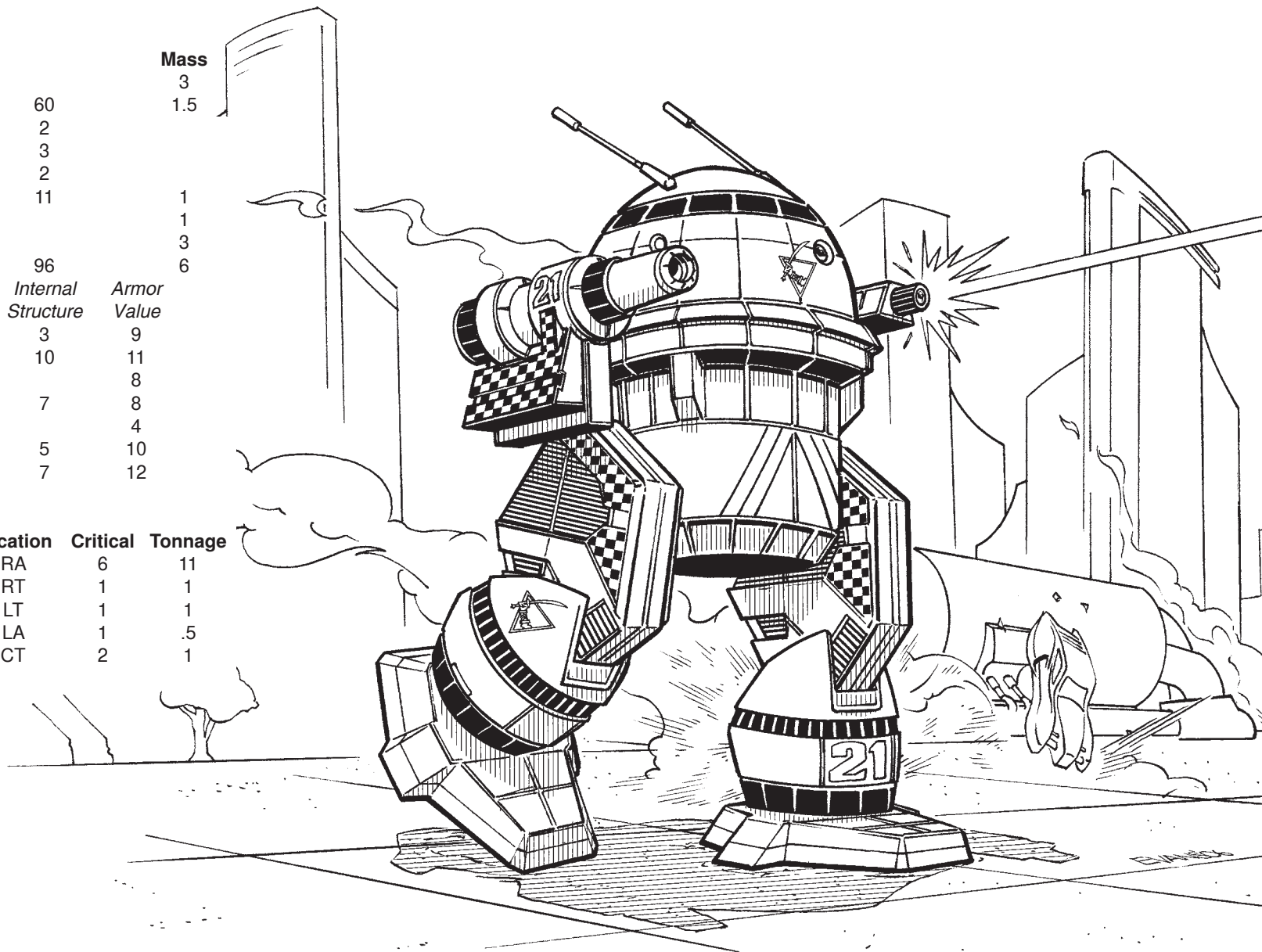

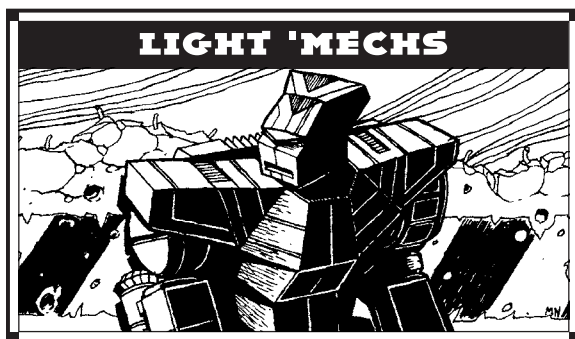

**Mass:** 35 tons

**Chassis:** Foundation Ultralight Endo Steel

**Power Plant:** Omni 210

**Cruising Speed:** 64 kph

**Maximum Speed:** 97 kph

**Jump Jets:** Luxor Load Lifters

**Jump Capacity:** 180 meters

**Armor:** Durallex Nova

**Armament:**

4 Hotshot Flamers

2 Defiance B3M Medium Lasers

1 Diverse Optics Type 10 Small Laser

1 SureFire 444 Anti-Missile System

**Manufacturer:** Coventry Metal Works

**Primary Factory:** Coventry

**Communications System:** Cyclops 14

**Targeting and Tracking System:** Cyclops-Beagle  
Sensory Probe

## Overview

A specialty BattleMech originally designed by Argile Technologies on Skye, the *Firestarter* became the de facto standard for incendiary platforms. With production numbering well into the thousands, *Firestarters* were a common sight among House and mercenary troops throughout the Succession Wars. When the Argile plant (and corporate headquarters) was leveled on Skye during the Third Succession War, several other BattleMech manufacturers immediately began producing their own. As a result, the *Firestarter* has many variants that are still in service today. Because most of the designs share commonly made parts, these cheap, light 'Mechs are easy to maintain and thus a staple in many reconnaissance and garrison units.

The *Firestarter's* popularity and ease of manufacture made it an ideal candidate for "omnification," resulting in Luthien Armor Work's FS9-O medium OmniMech series.

## Capabilities

Originally intended as a mobile incendiary 'Mech, the *Firestarter* evolved into a decent scouting and reconnaissance platform. Amid the rediscovery of Beagle probes and Guardian ECM suites, Coventry Metal Works was one of the first to produce a dedicated scout platform with the FS9-S and FS9-S1 variants. With the advent of the *Firestarter* Omni series, interest in the original design waned.

## Deployment

Both ancient and newer *Firestarters* can still be found in abundance among planetary militias and House units. Even with the capture of CMW's primary facility on Coventry by Blakist forces, spare parts are available from other *Firestarter* manufacturers (including LAW, Ceres Metals, Defiance, and Independence Weaponry).

Loki field offices along the Circinus Federation border are concerned about several reported instances of a new variant utilizing endo steel technology on Federation-raided worlds. This new variant seems designed to spread chaos and destruction with its specialized load-out.

*Firestarters* have also been spotted in Level II-sized formations among Blakist forces in their Protectorate, most often seen at "police demonstrations" and guarding suspected prison camps. These variants are surmised to be products of Coventry.

## Variants

Coventry's limited foray in the Periphery market included a variant loaded with several one-shot rocket pods, ferro-fibrous armor and double heat sinks. Though very capable of defending itself with the additional firepower, the design never took off as most Periphery customers already had a large number of *Firestarters* available to them.

The Circinian design—seemingly manufactured within the Federation—sports an endo-steel structure, paired flamers and small lasers, and an SRM two-pack

in the torso. Without exception, these Federation *Firestarters* are loaded with infernos, which are used wantonly during the recent raiding along the Alliance border. Whole cities have been set ablaze for no apparent reason other than instilling fear in the populace.

One Wolfnet report included a detailed schematic of a new Blakist variant that seems to be coming off the captured CMW line on Coventry, which was believed to be destroyed by the initial Word of Blake assault. Dubbed the FS9-B, it mounts a C<sup>3</sup>i computer system, three flamers, an extended-range medium laser, endosteel and light ferro-fibrous armor, and the design is highly mobile with the inclusion of an improved jump jet system. It also has a heat problem, which generally relegates it to garrison and defensive roles.

## Notable MechWarriors

**Portia "Torrent" Ryan:** Claiming to be a relation of the famed pirate Redjack Ryan, Portia Ryan managed to fight her way into Paula "Lady Death" Trealine's good graces with her timely interruption of an assassination attempt, during a visit to her Tortuga Dominions. Rewarded with the leadership of Scourge Company, Portia's obsessive attention to detail has served her well in several scouting missions along the Concordat border. Her compulsive nature is accented by her obsessive nature with fire; when given leave, she meticulously sets raging fires that are not only destructive, but when observed from above, eerily symmetrical to the point of being works of art.

**Adept Cornelius "Dante" Jones:** A convicted arsonist on Terra, Jones avoided Amazonia's death penalty by accepting an offer to serve in the Word of Blake's Mortuary Unit (the Mortuarii). Used primarily as a clean-up unit, this Level II consists mainly of Oppie HazMat Recovery Vehicle teams, converted APC "body wagons," and Jones' probe-equipped FS9-S *Firestarter*. The Mortuarii's sole purpose is to clean selected sites of battlefield debris so that the Word of Blake may then redevelop the area for other usage. Jones indulges his fascination with fire by torching battle-damaged structures. With his continuing experience, he has developed a keen eye on how to place a fire to bring down a structure in the fastest possible time.



# FS9-S FIRESTARTER

Type: **Firestarter**

Technology Base: Inner Sphere

Tonnage: 35

Battle Value: 760

## Equipment

		Mass
Internal Structure:	Endo Steel	2
Engine:	210	9
Walking MP:	6	
Running MP:	9	
Jumping MP:	6	
Heat Sinks:	10	0
Gyro:		3
Cockpit:		3
Armor Factor:	88	5.5

	Internal Structure	Armor Value
Head	3	9
Center Torso	11	13
Center Torso (rear)		6
R/L Torso	8	10
R/L Torso (rear)		6
R/L Arm	6	7
R/L Leg	8	7

## Weapons and Ammo

	Location	Critical	Tonnage
Flamer	RA	1	1
Flamer	CT	1	1
Flamer	CT (R)	1	1
Flamer	LA	1	1
Medium Laser	LA	1	1
Medium Laser	RA	1	1
Small Laser	RT	1	.5
Anti-Missile System	LT	1	.5
Ammo (AMS) 12	LT	1	1
Beagle Active Probe	LT	2	1.5
Jump Jets	RT	3	1.5
Jump Jets	LT	3	1.5

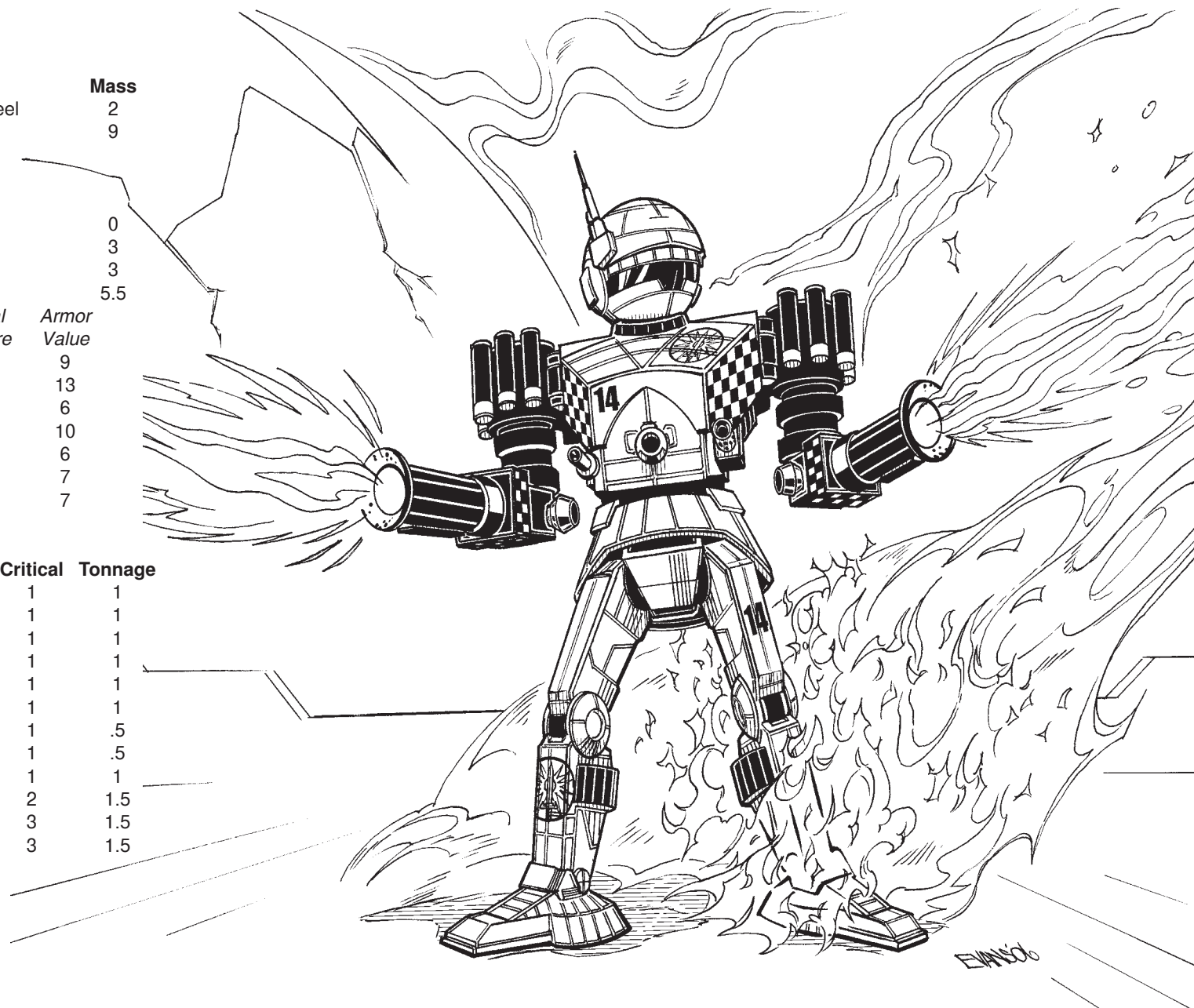

EMV06

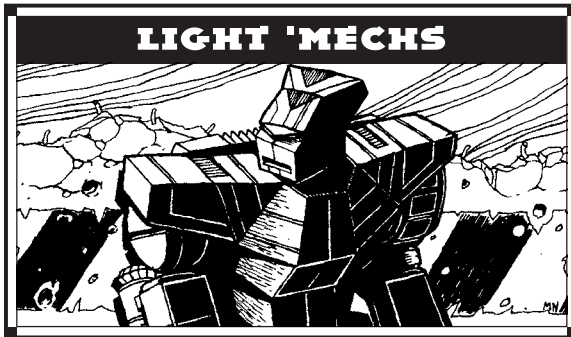

**Mass:** 35 tons

**Chassis:** Alshain Class 48

**Power Plant:** Magna 245

**Cruising Speed:** 75 kph

**Maximum Speed:** 118 kph

**Jump Jets:** Lexington Ltd. Lifters

**Jump Capacity:** 150 meters

**Armor:** New Samarkand Royal Ferro-Fibrous  
with CASE

**Armament:**

1 Telos SRM-4 Missile Rack

4 Victory 23R Medium Lasers

**Manufacturer:** Luthien Armor Works

**Primary Factory:** Abiy Adi

**Communications System:** Sipher Security Plus

**Targeting and Tracking System:** Matabushi Sentinel

## Overview

A favorite light BattleMech among many Draconis Combine MechWarriors, the *Jenner* emphasized speed and short-range firepower over the armor and the hard-hitting long-range punch of the *Panther*. Often these two designs would be paired up, with the *Panther* providing covering fire while the *Jenner* flanked a target to hammer its rear. *Jenners* were one of the benchmarks used to compare all of the newly designed BattleMechs in the Draconis Combine, and the design subsequently was the first choice for the application of newly rediscovered technology on a widespread level.

## Capabilities

When Star League-era technology began to be widely distributed, Luthien Armor Works deliberately

avoided several other new technologies to preserve the core advantages of the original *Jenner*. With the biggest problem being the chance of a catastrophic ammunition explosion, a half-ton of armor was sacrificed to employ CASE. To compensate, ferro-fibrous armor was added, giving the K-model *Jenner* practically an unchanged amount of protection.

## Deployment

With only minor changes to the design, the K-model *Jenner* began replacing D-model with no noticeable interruption in production. Though popular initially, over time pilots began to complain about being consistently outclassed by other designs using more advanced technology. However, since the design was quick and cheap to produce, LAW was reluctant to make any further changes to it. As first generation Inner Sphere OmniMechs rolled off the assembly line and other new light BattleMech designs were introduced, many Prefecture commanders began quietly mothballing their K *Jenners* as newer BattleMech designs became available.

The spectacularly brutal start to the Jihad, which quickly followed the Dominion War and the border clashes with rogue Federated Suns units, led many units to go back to the stockpiles of once-shunned K *Jenners* for replacement machines. Though technologically obsolete, they are proving themselves valuable once again, as it is easier to scrounge parts for their older design.

## Variants

Those who refused to send their *Jenners* into mothballs justified their existence by swapping out a single medium laser for a C<sup>3</sup> slave. Dubbed the JR7-C, these units became valuable spotters for a C<sup>3</sup> company.

The new production line on Abiy Adi finally gave designers a chance to give the *Jenner* a fresh new look utilizing cutting edge technology. Borrowing from the highly praised Clan *Jenner IIC*, LAW engineers traded out all the weapons for a trio of multiple missile 5-packs with a ton of ammunition for each launcher. In order to make room for the hefty launchers, the designers added an extra-light engine and took advantage of recently acquired technology by adding

a small cockpit and an extra light gyro. Heavy ferro-fibrous armor was added to increase the protection, and a C<sup>3</sup> slave module rounded out the design. C2 models have begun to roll off the assembly line in the last few months.

A number of other field upgrades have been noted since the onset of the Jihad as MechWarriors use whatever advanced tech is at hand to upgrade their venerable machines. Most common of these informal variants is the JR7-C3, which replaces the *Jenner's* medium lasers with ER models, while exchanging the heat sinks for double-strength versions. The SRM-4 and CASE are removed for an extra heat sink, a C<sup>3</sup> slave unit, and an extra 1.5 tons of ferro-fibrous armor. This is a superior raider as it is able to operate without re-supply for long periods. This variant has been spotted on the many battlefields of Luthien and Dieron.

## Notable MechWarriors

**The Blood Dragons:** A unit of surviving Black Watch members turned fugitives during the Blakist siege on Dieron, this makeshift group evaded capture and broke into a supply depot that carried a company of mothballed model K *Jenners*. The unit has since been waging a guerilla campaign in Blakist-held territory, and although they are down to only a third of their original strength, their exploits and constant evasions have become a source of morale as their story is spread throughout the Combine by the Voice of the Dragon.

**Busosenshi Grace Shiro:** A decided terror on the battlefield, Shiro uses her "Caf's" impressive mobility with exceptional finesse. Putting herself in harms' way is typical, to provide accurate Intel for Sorenson's Sabres. The current whereabouts of this unit, however, are unknown as they've gone missing from Luthien's horrific battlefield.

# JR7-K JENNER

Type: **Jenner**

Technology Base: Inner Sphere

Tonnage: 35

Battle Value: 889

## Equipment

		Mass
Internal Structure:		3.5
Engine:	245	12
Walking MP:	7	
Running MP:	11	
Jumping MP:	5	
Heat Sinks:	10	0
Gyro:		3
Cockpit:		3
Armor Factor:	62	3.5

	Internal Structure	Armor Value
Head	3	7
Center Torso	11	9
Center Torso (rear)		2
R/L Torso	8	8
R/L Torso (rear)		4
R/L Arm	6	4
R/L Leg	8	6

## Weapons and Ammo

	Location	Critical	Tonnage
2 Medium Lasers	RA	2	2
2 Medium Lasers	LA	2	2
SRM 4	CT	1	2
Ammo (SRM) 25	RT	1	1
CASE	RT	1	.5
Jump Jets	RT	2	1
Jump Jets	LT	2	1
Jump Jet	CT	1	.5

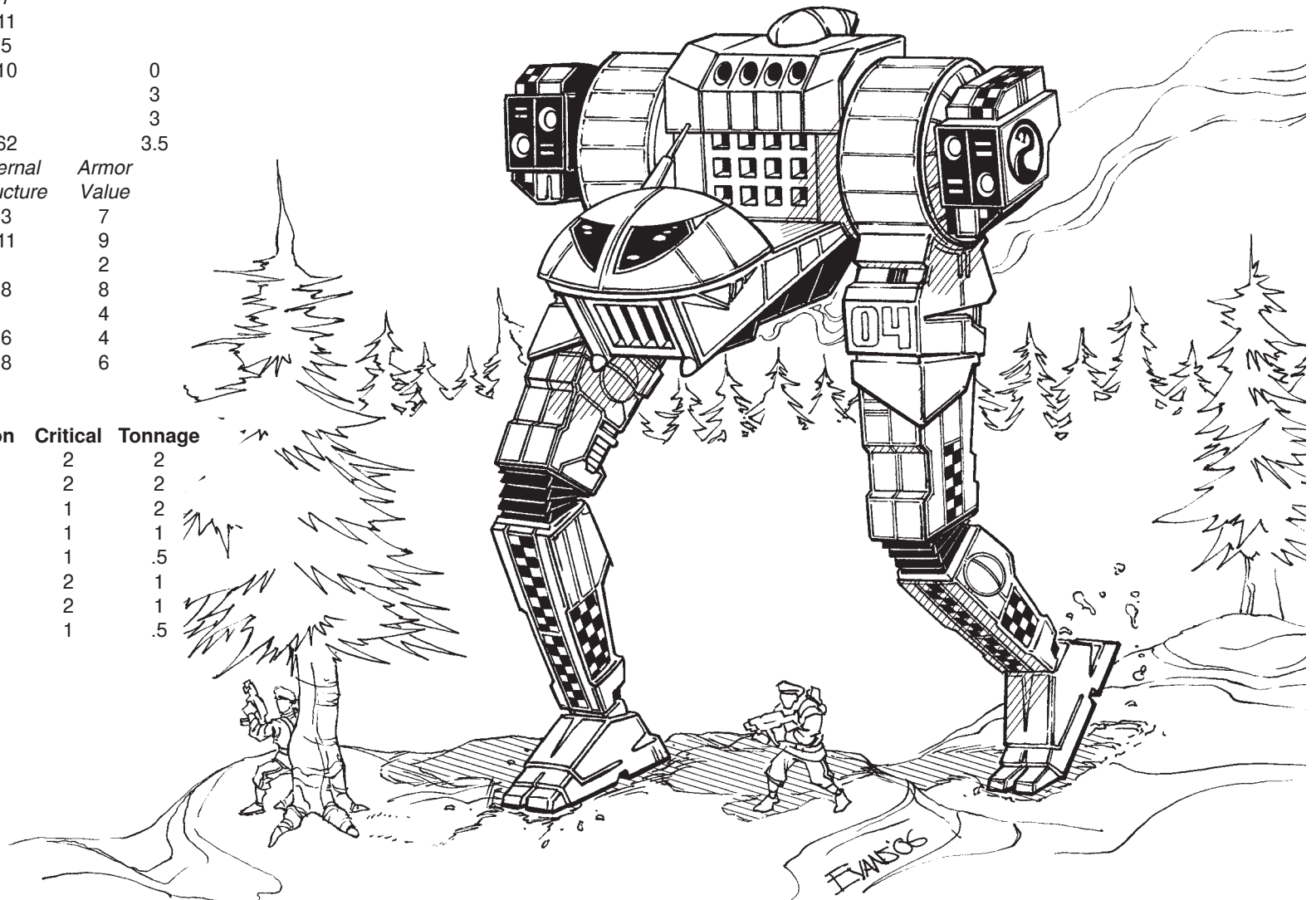

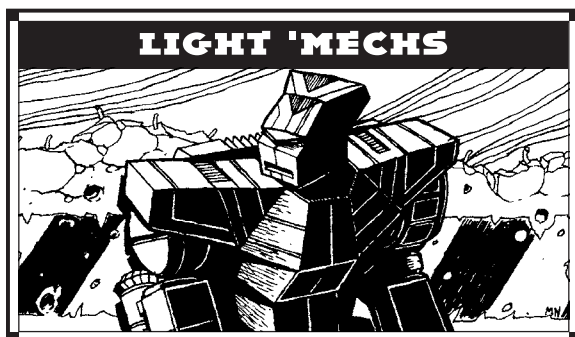

**Mass:** 35 tons

**Chassis:** Alshain 560-Carrier Endo Steel

**Power Plant:** Hermes 140

**Cruising Speed:** 43 kph

**Maximum Speed:** 64 kph

**Jump Jets:** Lexington Ltd. Lifters

**Jump Capacity:** 120 meters

**Armor:** Maximillian 42

**Armament:**

1 Telos-4 Short-Range Missile Delivery System

1 Lord's Light 2 Extended-Range Particle Projector Cannon

**Manufacturer:** Wakazashi Enterprises

**Primary Factory:** New Samarkand

**Communications System:** Sipher CommCon SCU-4

**Targeting and Tracking System:** Cat's Eyes 5 with Artemis IV System

## Overview

Produced by Alshain Weapons for centuries, the *Panther* has been the preeminent light BattleMech design for the Draconis Combine throughout the Succession Wars. The *Panther* was also a mainstay of the Free Rasalhague Republic's KungsArmé after the tiny nation's inception in 3034, since AW's main factory complex is located on New Oslo.

After the arrival of the Clans, both AW factories on New Oslo and Jarett were captured and converted to other uses. Though AW eventually crash-built a new facility on Tok Do, the company could barely maintain pre-Clan production levels and thus concentrated on providing upgrade packages and abundant spare parts.

With the initial success of its production of the Valiant—and answering *Kanrei* Minamoto's call for industry diversification—Wakazashi Enterprises bought the production license of the *Panther*. Instituting a cosmetic redesign (for a more menacing look) and incorporating new weapons technologies, *Panthers* are now walking off the assembly line on New Samarkand.

## Capabilities

The PNT-10K model is still produced in limited quantities on Tok Do by Alshain Weapons. Because of the factory's non-stop production of *Panthers* ever since the newer facility went online in 3053, the -10K has replaced the venerable -9R as the most common model seen in the DCMS. Utilizing the solid Lord's Light 2 ER PPC and Artemis-equipped SRMs, the -10K is a steel backbone to many recon and pursuit lances in the Combine. Most DCMS officers require their new recruits to pilot a *Panther* in their first few years to learn how to manage the 'Mech's heat curve in combat, giving them valuable combat experience from the start.

## Deployment

Every DCMS line unit has several *Panthers* in their rosters, mostly the PNT-10K workhorse design. Prestigious units such as the Genyosha and Sword of Light regiments also utilize the more heat-efficient PNT-12A variant. Only recently has the -16K been seen among units in the Galedon District as well as being the cargo of several smuggling runs into the Luthien system.

## Variants

The PNT-C is a simple field-refit that trades out the Artemis FCS for a C<sup>3</sup> slave unit. The PNT-12A, however, is a more radical design that trades out all the PNT-10K's weaponry and three single heat sinks for an extended-range large laser, Streak SRM-4 and medium pulse laser slaved to a targeting computer, along with ten double heat sinks and more armor.

Wakazashi recently premiered a new variant, the PNT-16K. This *Panther* incorporates new light ferro-fibrous armor weave, giving more protection to the legs and torso. Two Streak SRM-4 systems increase the potency of the design, while double heat sinks reduce

its heat curve. This variant has been well received by Galedon District forces and has the potential to supplant the -10K as the DCMS' workhorse design.

Most concerning, however, are the reports from Dieron concerning a model dubbed the -14S. This Blakist design carries a snub-nosed PPC, overly large jump jets (with reports of extended jumps of 180 meters), and two one-shot rocket launcher systems. One unconfirmed report also mentioned a smaller-than-standard cockpit assembly. Both the ISF and O5P are initiating operations to determine the location of the factories producing this deadly design.

## Notable MechWarriors

**Seylah Teresa Martinez:** A member of Sorenson's Sabres Fire Lance, Seylah recently received a PNT-14S *Panther* smuggled to her on Luthien by an unknown yakuza clan. It is believed to be a gift and replacement for her "*Dominion II*," a PNT-12A destroyed during a headhunting mission against Word of Blake forces. She and fellow lancemate Rachel Popovich destroyed several vehicles and battle armor troops that were attempting to breach a medical complex. Rumor has it that an important clan *oyabun* was being treated inside for thyroid cancer, and their desperate defense gave him enough time to escape. Reports have it that Martinez has already put her "*Deadly Domain*" to good use, using its improved maneuverability to get behind WoB units and perform her own brand of battlefield justice.

**Trevor Myguchi:** A refugee from the shattered First Tyr Regiment, Myguchi managed to hook up with the Twenty-first Centauri Lancers on Tukayyid in 3071 after their rescue by Ghost Bear Dominion forces. Myguchi accepted the Lancers' offer to join the rebuilding unit and took a post as commander for the paltry recon lance. Though downgraded to an ancient PNT-9R design, Myguchi offers up no complaint, grateful to have the opportunity to be back in a 'Mech cockpit. Currently, Myguchi is working with the Lancers' quartermaster to secure an old stockpile of *Panthers* located on Jarett, though the Dominion's merchant caste is being quite obstinate.

# PNT-10K PANTHER

Type: **Panther**

Technology Base: Inner Sphere

Tonnage: 35

Battle Value: 838

## Equipment

Internal Structure:	Endo Steel	2
Engine:	140	5
Walking MP:	4	
Running MP:	6	
Jumping MP:	4	
Heat Sinks:	13	3
Gyro:		2
Cockpit:		3
Armor Factor:	104	6.5

	Internal Structure	Armor Value
Head	3	9
Center Torso	11	14
Center Torso (rear)		7
R/L Torso	8	10
R/L Torso (rear)		5
R/L Arm	6	10
R/L Leg	8	12

## Weapons and Ammo

	Location	Critical	Tonnage
SRM 4	CT	1	2
Ammo (SRM) 25	LT	1	1
CASE	LT	1	.5
Artemis IV FCS	CT	1	1
ER PPC	RA	3	7
Jump Jets	RL	2	1
Jump Jets	LL	2	1

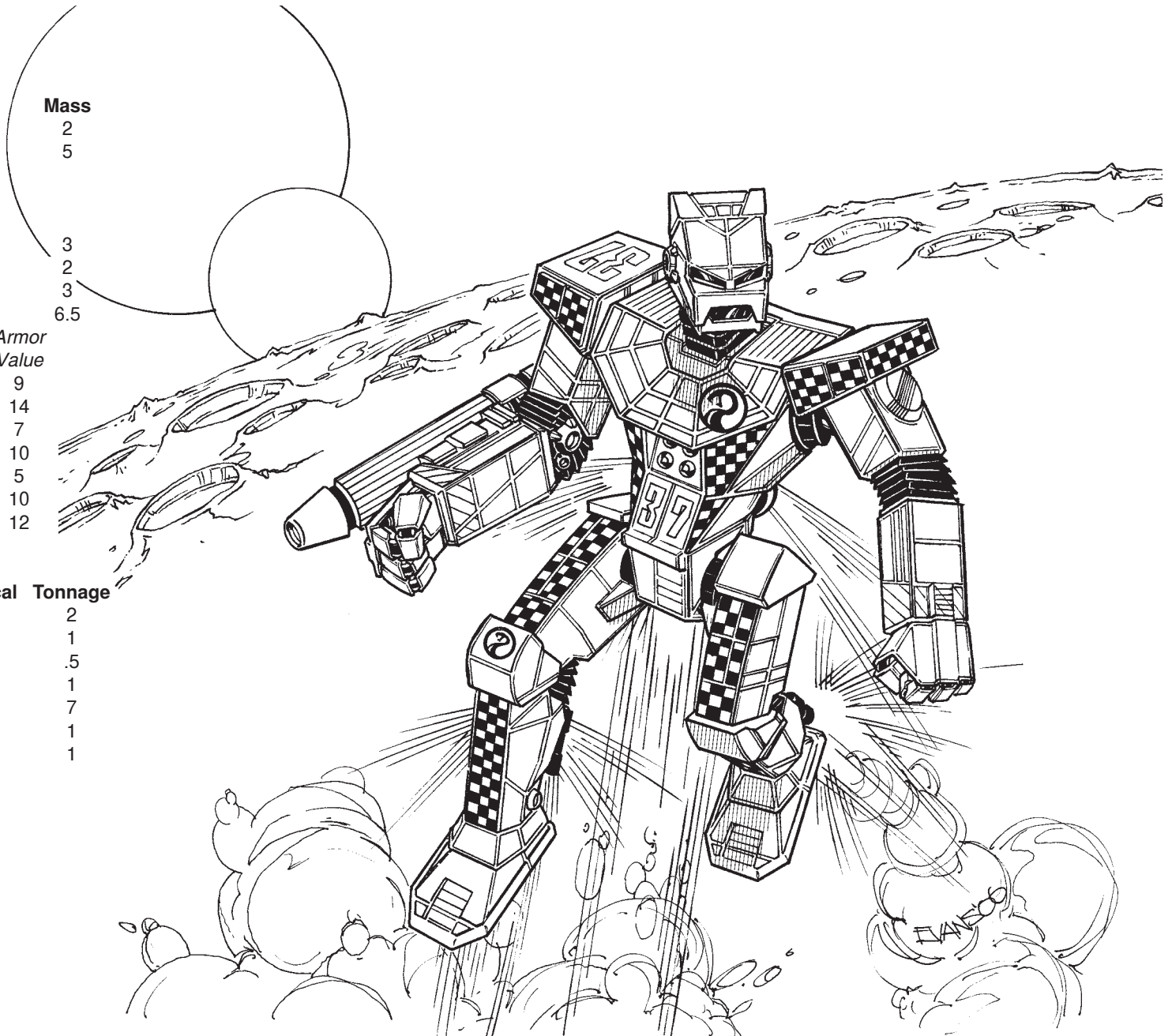

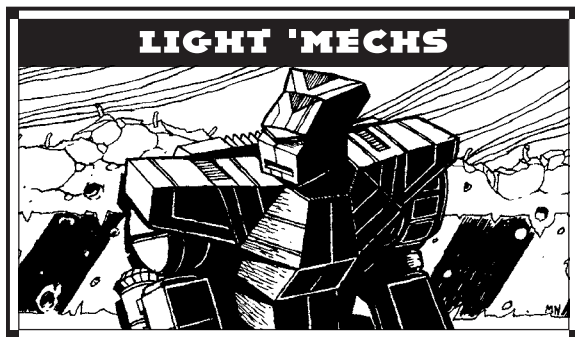

**Mass:** 35 tons

**Chassis:** Hellespont Type R

**Power Plant:** Hermes 210 XL

**Cruising Speed:** 64 kph

**Maximum Speed:** 97 kph

**Jump Jets:** None

**Jump Capacity:** None

**Armor:** Hellespont Lite Ferro-Fibrous with CASE

**Armament:**

1 Harpoon-6 SRM 6

2 Ceres Arms Medium Lasers

1 Apple Churchill Beagle Active Probe

1 Apple Churchill Guiding Light Narc Missile Beacon

**Manufacturer:** Hellespont 'Mech Works

**Primary Factory:** Sian

**Communications System:** Ceres Metals Model 666 with Guardian ECM

**Targeting and Tracking System:** Apple Churchill 2000 with Beagle Probe and 442x TAG

## Overview

As the Third Succession War limped to its close, the Capellan Confederation took the unusual step of developing several new BattleMech designs. Several had analogues among the designs fielded by other houses, but one design, the RVN-1X *Raven*, was unique in that it was designed to provide electronic warfare and countermeasure support for CCAF formations. It was envisaged as a stand-off platform, selecting targets for its lance-mates and artillery batteries using advanced electronics and hindering enemy sensors.

The prototype model met with mixed success—it was too ambitious, and the electronics, while advanced,

didn't provide sufficient edge to influence combat. The *Raven* was relegated to the ranks of other light 'Mechs, particularly in the chaos of the Fourth Succession War and the five-year conflict against Andurien and Canopus that followed. The recovery of technologies brought about by the Gray Death Core provided new impetus to the program, and in the late 3040s Hellespont 'Mech Works were able to field an improved version of the *Raven* that lived up to the original design brief. Other designs have since used many of the systems employed in the *Raven*, but none offer the compact and effective package the *Raven* provides.

## Capabilities

Advanced materials pervade the *Raven*, from its compact power plant, cellular ammunition storage and lighter armor composites to its target acquisition gear, Guardian ECM and Beagle Active Probe. The electronics are manufactured by the Apple Churchill consortium (which also supplies the Narc launcher), whose elegant design offers seamless integration and ease of use. Only the external communications gear isn't provided by Apple Churchill, but it has been integrated with the other systems despite a few early problems with communications protocols.

The *Raven's* weaponry is light for its size—a pair of medium lasers and an SRM-6—but in conjunction with its speed and armoring, the weapons are more than sufficient to protect the *Raven* until support can arrive. Indeed, a mission where the *Raven* is forced into a combat role is often deemed a failure by the CCAF.

## Deployment

The CCAF has attempted to retain exclusive control over the *Raven*, but a variety of factors have seen the design spread to other powers. First and foremost was the Confederation's need for foreign currency that saw a number of units exported to both the Free Worlds and the Combine. The former has by far the greatest number of *Ravens*, a result of technology sharing by the two powers in the 3050s. Other examples made their way into Steiner and Davion hands due to clashes between the powers over the years, though Operation Sovereign Justice saw a number of damaged *Ravens* fall into the hands of Capellan March forces. These shattered *Ra-*

*vens* have been rebuilt and equipped by Hasek's troops and turned against their original designers.

## Variants

Introduced in the early 3060s, the RVN-4L was the test-bed design for the Capellans' stealth armor project. Employing ten double heat sinks, the -4L upgrades the medium lasers to ER models, and mounts six tons of stealth armor.

Most of the Hasek "Shattered *Ravens*" required extensive reconstruction and were re-armed with weapons significantly different from the Capellan original. One configuration makes extensive use of machine gun arrays instead of the medium lasers—most of the Hasek *Ravens* were captured by infantry assaults—while another replaces the SRM-6 with a Streak launcher, dropping the Narc system to provide space for the bulkier launcher and additional lasers and heat sinks.

## Notable MechWarriors

**Sao-shao Danielle Chu:** When renegade AFFS forces attacked the Capellan Confederation on the orders of Duke Hasek, there was little the CCAF could initially do to stop them. Garrison forces on most worlds staged a valiant defense, including on Warlock where *Sao-shao* Danielle Chu fought a spirited mobile campaign against the aggressors. Exploiting the capabilities of her *Raven* to the max, Chu led her forces against the weak spots of Hasek's occupiers, blinding their sensors and focusing attacks on key installations and units. The *Raven's* sensors and electronics vastly simplified this challenging task, making the Davions pay in blood for their folly. Unfortunately, Chu's unit fell foul of an AFFS airstrike shortly after one of their daring raids, with several 'Mechs rendered non-functional. Chu's *Raven* was one such victim, leg damage meaning it had little chance to evade the pursuing forces. With a heavy heart, demolition explosives were planted to destroy the valuable machine. Unfortunately, it appears the destruction may have been incomplete; a *Raven* bearing the same designation as Chu's machine has been identified in the AFFS forces.

# RVN-3L RAVEN

Type: **Raven**

Technology Base: Inner Sphere

Tonnage: 35 tons

Battle Value: 710

## Equipment

Internal Structure:

Engine:

Walking MP:

Running MP:

Jumping MP:

Heat Sinks:

Gyro:

Cockpit:

Armor Factor:

		Mass
	210 XL	3.5
		4.5
	6	
	9	
	0	
	11	1
		3
		3
	80	4.5

	Internal Structure	Armor Value
--	--------------------	-------------

Head	3	6
Center Torso	11	11
Center Torso (rear)		3
R/L Torso	8	11
R/L Torso (rear)		3
R/L Arm	6	8
R/L Leg	8	8

## Weapons and Ammo

	Location	Critical	Tonnage
SRM 6	RT	2	3
Ammo (SRM) 15	LT	1	1
2 Medium Lasers	RA	2	2
Narc Missile Bacon	LA	2	3
Ammo (Narc) 12	LT	2	2
Beagle Active Probe	CT	2	1.5
TAG	RT	1	1
Guardian ECM Suite	LT	2	1.5
CASE	LT	1	.5

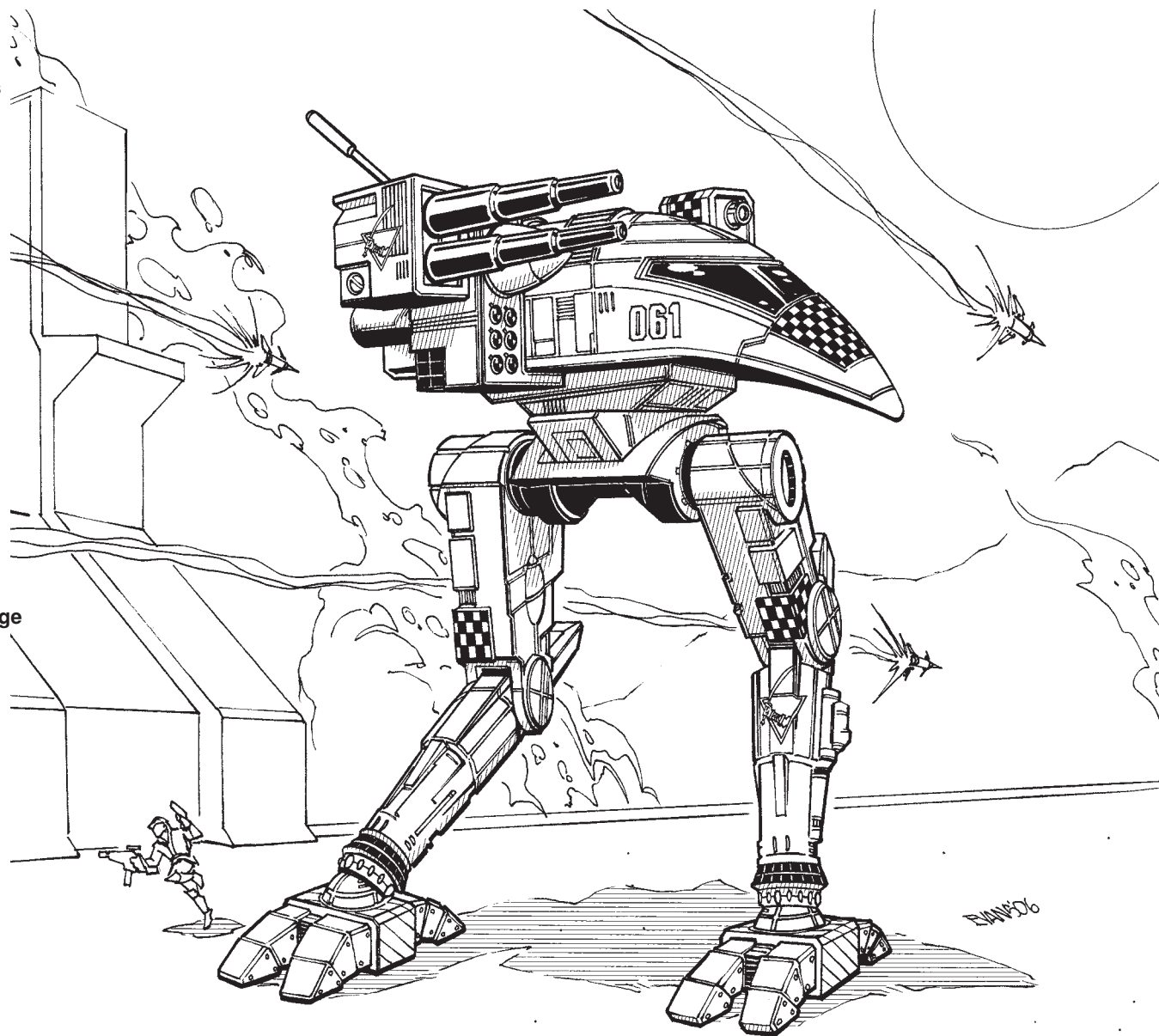

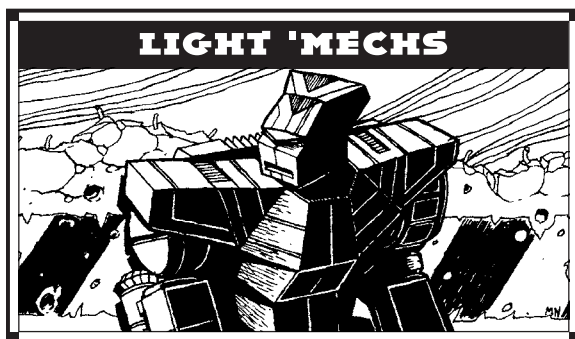

**Mass:** 35 tons  
**Chassis:** Arc-Royal KH/3  
**Power Plant:** GM 210  
**Cruising Speed:** 64 kph  
**Maximum Speed:** 97 kph  
**Jump Jets:** None  
**Jump Capacity:** None  
**Armor:** Durallex Medium  
**Armament:**  
1 Cyclops XII Extended-Range Large Laser  
4 Defiance B3M Medium Lasers  
**Manufacturer:** TharHes Industries,  
Arc-Royal MechWorks (under license)  
**Primary Factory:** Tharkad, Arc-Royal  
**Communications System:** O/P COM-22/H47  
**Targeting and Tracking System:** Digital Scanlok 347

## Overview

Debuting just before the Fourth Succession War as a prototype design first field tested by the Kell Hounds and Wolf's Dragoons mercenary commands, the Lyran-made *Wolfhound* is still regarded today as one of the greatest light 'Mechs ever produced by the Steiner military, a "laser boat" ideal as both a raider and a hunter-killer. The technological renaissance of the 3030s enabled engineers on Tharkad to produce the even deadlier WLF-2 model to face the Clan invasion, though the retooling of TharHes factories was completed too late to stall the offensive before ComStar's victory on Tukayyid in 3052.

## Capabilities

Built for survival and for consistent operations far from supply lines, the *Wolfhound* uses an all-laser

weapons load effective to all combat ranges and sports the maximum armor possible for a BattleMech of its size. Both the WLF-1 and the WLF-2 models also used standard armor, engine, and structure components, keeping costs low, though the upgraded version changed its primary weapon to the extended-range variety and significantly enhanced its ability to handle to the heat load by using double-strength freezers. These capabilities made the *Wolfhound* especially effective against its chosen prey: the Draconis Combine's *Panther*.

## Deployment

With its birth closely tied to that of the Steiner-Davion alliance, *Wolfhounds* became quite common among the armed forces of both halves of the FedCom states. Manufacturing remained a solely Lyran operation, however, with two major producers on Tharkad and Arc-Royal, and so the vast majority of these machines wound up with units—House and mercenary alike—that were stationed in the Steiner realm. Indeed, the WLF-3S model, produced after the formal creation of the Lyran Alliance as an independent state, found itself shipped only to the most loyal of Lyran troops prior to and throughout the FedCom Civil War.

The Word of Blake assault on Tharkad at the dawn of the Jihad saw the TharHes plants critically damaged by orbital bombardments and a subsequent ground invasion, effectively shutting down *Wolfhound* production on the Lyran capital. The Arc-Royal facilities have responded by ramping up production and have even introduced a new model, the WLF-4W, which is being used to fill gaps in the Wolf's Dragoons, Kell Hounds, and other mercenary and House forces currently stationed throughout the Donegal Province.

## Variants

The WLF-2 differs very little from the original WLF-1 that entered production in 3028. Produced before the widespread recovery of Star League weapons technology, the older model sported a Setanta-model large laser rather than the current Cyclops XII, and it had standard heat sinks, which were often taxed in combat.

The WLF-3S, produced only from the TharHes plants during the Civil War, used a light fusion engine and an endo-steel frame so the 'Mech could swap its Cyclops for a Defiance 1001 ER PPC, and upgrade its forward-firing medium lasers to extended-range models while downgrading the rear-firing medium laser to an ER small. The remaining weight savings allowed for additional double heat sinks, which could still be overwhelmed in battle.

Using the WLF-2 as its basis, the Arc-Royal-produced WLF-4W *Wolfhound* is built more as a medium-range brawler than the 3S model. This variant upgrades the WLF-2's chassis to an endo-steel frame and swaps its weapons load with three torso-mounted light PPCs and a paired ER medium and ER small laser in the right arm.

## Notable MechWarriors

**Zachary "Hawk" Hawkins:** Once a close comrade-at-arms with General of the Armies Adam Steiner during their tour with the First Somerset Strikers, Hawkins has been seen lately working alongside the Star Seeds mercenary unit as LIC's liaison. While he still maintains his MechWarrior status, the *Wolfhound* he inherited from his Somerset Strikers days, "*Grit*", remains in storage at a family facility on Ryde. Rumor has it that Hawkins has pulled several favors to get some top-of-the-line technology pulled aside for him; whether the *Grit* will be upgraded from its classic WLF-1 load-out is a small mystery among his surviving relatives.

**Lt. Colonel Daniel Allard:** The youngest ever graduate from the NAIS, Daniel Allard immediately joined the Kell Hounds in 3015. Following the loss of his *Valkyrie* during the Silver Eagle incident, Colonel Morgan Kell awarded Allard the first *Wolfhound* prototype as a replacement in recognition of his services to the Hounds. One of Duke Kell's "inner circle," Daniel was promoted to Lt. Colonel and became the Kell Hounds field commander when Morgan retired. Although eligible for a heavier BattleMech, Allard continued to pilot the *Wolfhound* until he was killed fighting the Jade Falcons on Graceland in 3069.



# WLF-2 WOLFHOUND

Type: **Wolfhound**  
 Technology Base: Inner Sphere  
 Tonnage: 35  
 Battle Value: 1,061

## Equipment

Internal Structure:		3.5
Engine:	210	9
Walking MP:	6	
Running MP:	9	
Jumping MP:	0	
Heat Sinks:	10 [20]	0
Gyro:		3
Cockpit:		3
Armor Factor:	119	7.5

	<i>Internal</i>	<i>Armor</i>
	<i>Structure</i>	<i>Value</i>

Head	3	9
Center Torso	11	16
Center Torso (rear)		6
R/L Torso	8	11
R/L Torso (rear)		5
R/L Arm	6	12
R/L Leg	8	16

## Weapons and Ammo

	Location	Critical	Tonnage
ER Large Laser	RA	2	5
Medium Laser	CT	1	1
Medium Laser	RT	1	1
Medium Laser	LT	1	1
Medium Laser	CT (R)	1	1

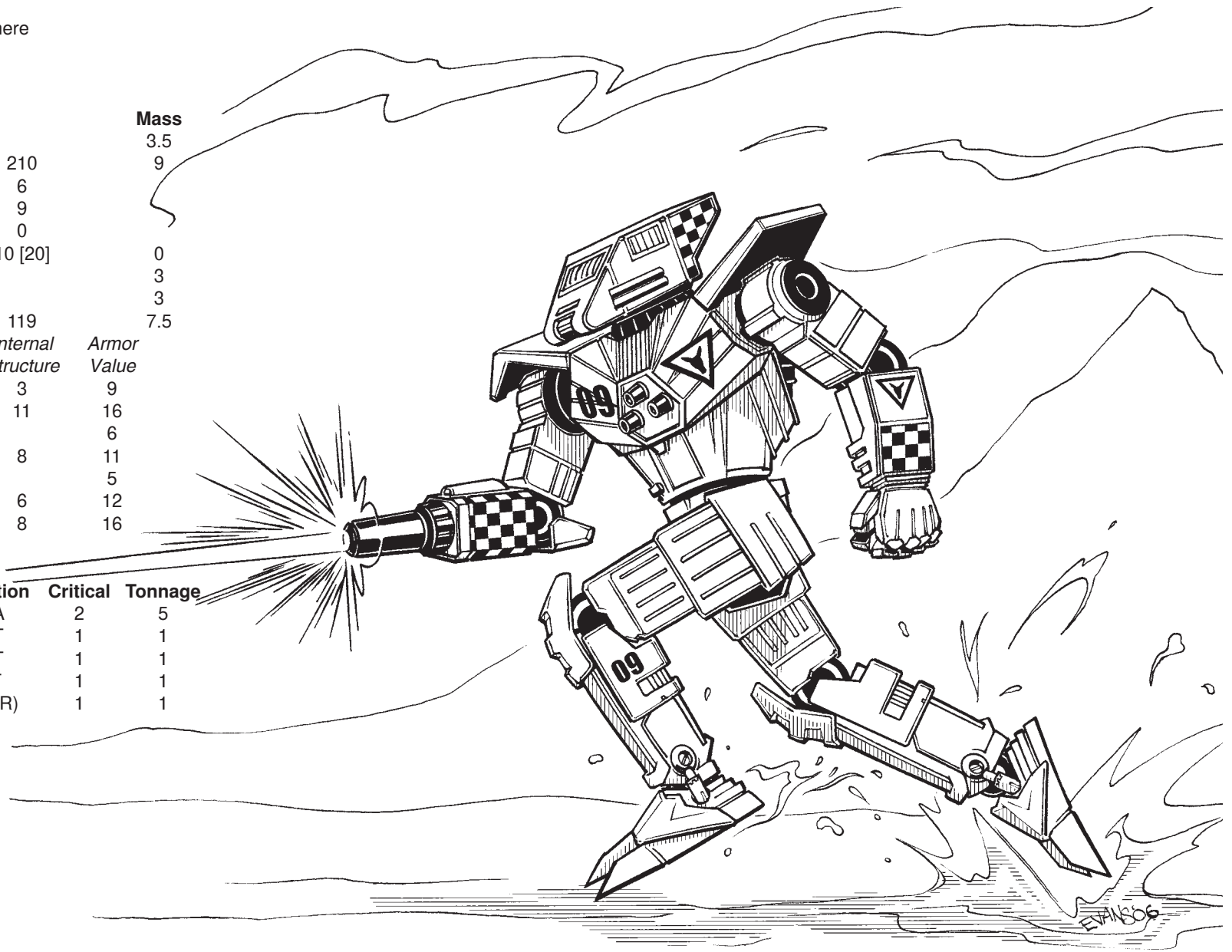

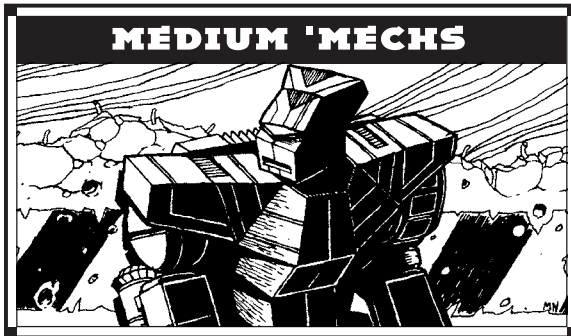

**Mass:** 40 tons

**Chassis:** Hellespont Type A 40 series

**Power Plant:** VOX 280

**Cruising Speed:** 75 kph

**Maximum Speed:** 118 kph

**Jump Jets:** 100AFVTA

**Jump Capacity:** 210 meters

**Armor:** Hellespont Industries Series 9

**Armament:**

1 Magna 400 P Medium Pulse Laser

1 Holly LRM-5 Rack

**Manufacturer:** Hellespont 'Mech Works

**Primary Factory:** Sian

**Communications System:** Ceres Metals Model 668

**Targeting and Tracking System:** Apple Churchill  
2000 with Artemis IV System

## Overview

Nearly a lost design, the *Assassin* was practically phased out after the influx of new 'Mechs hit most Inner Sphere militaries following 3058. The original design was never produced in great numbers by Maltex, and the *Assassin* saw limited combat engagements due to the rarity of spare parts. Most *Assassins* in service are the family heirlooms, usually with some custom modifications.

Even with the deluge of recovered technology that came about after the Clan Invasion, upgrades to such a mediocre design were few and far between. The Lyrans attempted a new variant at the beginning of the FedCom Civil War with the light fusion engine mounted on an endo-steel chassis. Battle reports remained cool, however, and the variant became a dog

for Defiance Industries, who had licensed the design from Maltex.

In late 3067, Hellespont 'Mech Works—buoyed by the success of their *Sha Yu* stealth BattleMech—expressed interest in acquiring the *Assassin* as a test-bed platform. Distracted by the unfolding events of the Jihad and facing several charges of illegal trading and tax evasion in the Federated Suns, while also being investigated for suspected Blakist links, Maltex quickly agreed and gave Hellespont full control over the design.

Though Hellespont began building several *Assassin* platforms for research and development, they also began mass-producing the -23 variant for the CCAF and various Capellan militias. While Hellespont executives probably dealt with Maltex in good faith in the beginning, the enormous loopholes in the licensing agreement have pretty much cut the troubled company out of any profits; consequently, Hellespont has been selling *Assassins* to the Magistracy, Concordant, and Confederation at reduced rates.

## Capabilities

Within the Confederation military, the *Assassin* has become a fire-support unit for fast-moving pursuit and strike lances. Though meant to work with the Artemis system, many CCAF commanders eschew the less common Artemis ammunition in favor of mine-delivering missiles. The practice is considered a waste by most veterans, but with a shortage on Artemis-equipped ammunition, these commanders work with what they have.

## Deployment

The majority of *Assassins* are seen in the CCAF, MAF, and TDF, usually in green units or reserves. Because better-equipped BattleMechs can perform much of the same roles (such as Hellespont's *Sha Yu*), *Assassins* are usually present as a cheap way to rebuild shattered forces. With the wanton destruction occurring everywhere, many militaries are relying on whatever they can afford.

## Variants

While the ASN-23 is the most common variant found on the battlefield today, there still exist some of

the original Maltex designs like the 21 and 101. Sporting a mix of short- and long-range weaponry, these 'Mechs are usually family heirlooms passed on through MechWarrior families. Because of the rarity of spare parts, however, many of these original designs sport some type of forced customization.

The ASN-30 is the odd-ball *Assassin* variant, and very rare, sporting more armor, an extended range medium laser and an LB 5-X AC.

Hellespont's original test-bed design has been seen in some combat theaters. Utilizing an XL engine, the newer design is blockier in its silhouette due to a major increase in armor. The ASN-99 also mounts one of the CCAF's new light PPCs and is equipped with target acquisition gear and two SRM-2 packs. Most intriguing is the inclusion of a Capellan dao in the *Assassin*'s left hand; a similar design was seen mounted on Roberta Rujji's *Assassin* "*Servitor*" on Solaris VII, though it is unlikely Hellespont is able to mass-produce a 'Mech-sized vibroblade.

## Notable MechWarriors

**The Ten Tigers:** No one really knows how this unit came about or to whom they give their allegiance. What is disturbing is the fact that all eight of their 'Mechs are ASN-99 models (Hellespont claims to have no record of any being stolen). The other two Tigers are two squads of Fa Shih battle armor, who ride into battle on their brethren. The Ten Tigers only show up in combat that involves the Word of Blake, usually appearing in the Blakist's rear area, disrupting logistical chains and in several cases, executing headhunting-style missions. The Tigers are recognized by their all-black paint scheme, with each unit sporting the Chinese character for a native Sian predator. While their existence is a blessed enigma for many of the CCAF commanders, their continued success has spawned a small cult movement on several worlds near the Blakist Protectorate.

# ASN-23 ASSASSIN

Type: **Assassin**

Technology Base: Inner Sphere

Tonnage: 40

Battle Value: 740

## Equipment

		Mass
Internal Structure:		4
Engine:	280	16
Walking MP:	7	
Running MP:	11	
Jumping MP:	7	
Heat Sinks:	10	0
Gyro:		3
Cockpit:		3
Armor Factor:	72	4.5
	<i>Internal Structure</i>	<i>Armor Value</i>
Head	3	8
Center Torso	12	12
Center Torso (rear)		4
R/L Torso	10	10
R/L Torso (rear)		2
R/L Arm	6	6
R/L Leg	10	6

## Weapons and Ammo

	Location	Critical	Tonnage
Medium Pulse Laser	RA	1	2
LRM 5	RT	1	2
Ammo (LRM) 24	RT	1	1
Artemis IV FCS	RT	1	1
Jump Jet	CT	1	.5
Jump Jets	RT	3	1.5
Jump Jets	LT	3	1.5

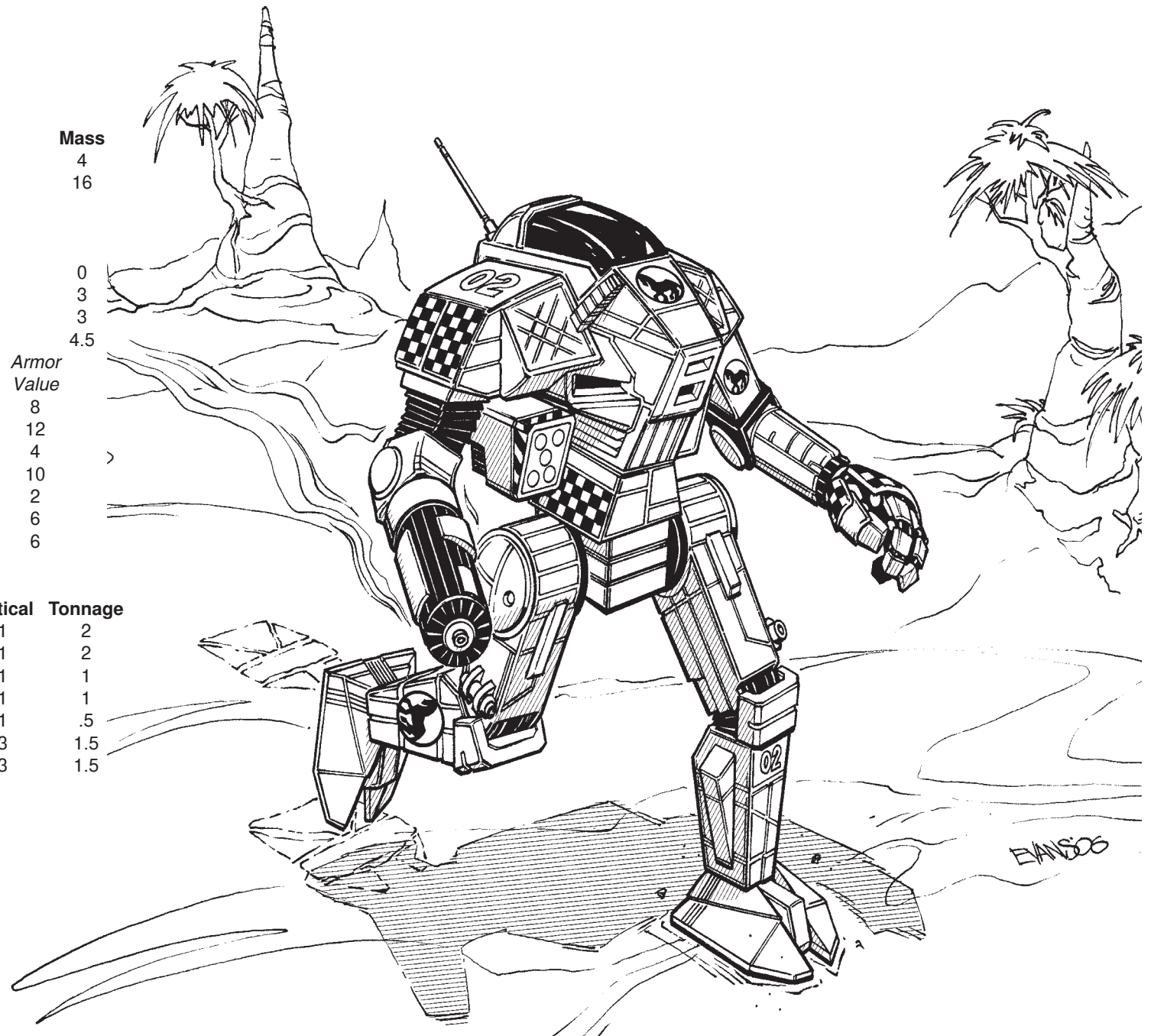

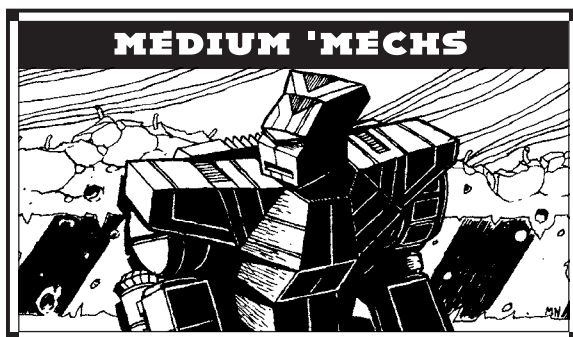

**Mass:** 40 tons

**Chassis:** Kell Reinforced 240

**Power Plant:** Pitban 320 XL

**Cruising Speed:** 86 kph

**Maximum Speed:** 129 kph

**Jump Jets:** None

**Jump Capacity:** None

**Armor:** Durallex Light with CASE

**Armament:**

1 Imperator Ultra Autocannon/5

2 Magna Mk. II Medium Lasers

1 Magna 200P Small Pulse Laser

**Manufacturer:** Free Worlds Defense Industries—

Gibson Federated BattleMechs

**Primary Factory:** Gibson

**Communications System:** Datacom 50

**Targeting and Tracking System:** Dynatec 1122

## Overview

By the end of the Fourth Succession War, the *Cicada* was rapidly fading into obscurity. Free Worlds Defense Industries rescued the 'Mech from that fate by producing it in increasing numbers at its newly refurbished factory on Gibson in the decade following the discovery of the Helm Star League Memory Core.

The *Cicada* was the perfect choice for FWDI to bring back into production. It gave the Free Worlds League Military a 'Mech class it desperately needed, especially following the long battle with Andurien in which the FWLM lost many valuable recon 'Mechs.

## Capabilities

Until the last days before the arrival of the Clans, the *Cicada* was widely recognized as the *Locust's* "big brother." Packing nearly the same punch as that lightest of BattleMechs with no more armor protection than the 'Mech it was meant to replace, the *Cicada* relied on its speed to keep it out of serious trouble. It was a 'Mech that could benefit significantly from a lostech upgrade.

Thus was born the CDA-3M. Now powered by an extralight version of the same Pitban 320-rated fusion engine that it had used for so long, the 'Mech gained back more than a quarter of its mass that it could devote toward a more impressive weapons loadout. Keeping with the *Cicada's* intended purpose as a reconnaissance platform, FWDI designers equipped it with an Imperator class-5 ultra autocannon. Additionally, the design retains the two original medium lasers but upgrades the Magna small laser to a pulse version.

## Deployment

The *Cicada* have served each of the Successor States in ever-dwindling numbers until its reintroduction some three decades ago. Until Captain-General Thomas Marik's agreement to supply the Draconis Combine and Federated Commonwealth with war materiel to combat the Clans, the great majority of newly constructed *Cicadas* went to the FWLM, particularly federal units like the Free Worlds Guards. Afterwards, most found their way to the Clan fronts, where their speed made them valuable against the technologically superior invaders. After the ComStar Schism and the Word of Blake's relocation to Gibson, a larger and larger percentage of the *Cicada* run was diverted to the Blakists' militia, who now rival the FWLM as the largest *Cicada* user.

## Variants

After seeing reports from the front during the Clan War, FWDI designers quickly debuted the 3F *Cicada*. Utilizing both endo-steel structure and ferro-fibrous armor, they mounted an extended-range PPC and two medium lasers on the better armored 'Mech, which they also turned into a jumper—an ability no *Cicada*

variant previously possessed. The 3G uses the same base chassis, but is a more dedicated recon platform, trading the 3F's ER PPC for an extended-range large laser and a Beagle active probe.

In the past year, FWDI introduced a new *Cicada*. By dropping its powerplant to a 280-rated reactor, engineers were able to free up enough mass to mount a Combine-developed heavy PPC, backed by four Diverse Optics ER medium lasers, all for a cost of just 10 kph off the 'Mech's top speed.

Not so much a new variant as a training 'Mech to introduce graduating cadets to the newest technologies, the CDA-3MA trades out the Ultra AC/5 for a snub-nose PPC, while significantly increasing armor protection.

## Notable MechWarriors

**Major Archibald Schoknecht:** Archie Schoknecht was just one lance commander of many in the First Crucis Lancers during the final FedCom Civil War battle for New Avalon. Two 'Mech companies and two infantry battalions were dropped onto the southeastern tip of the Avalon continent in early February of 3067 to secure beachheads for Victor Steiner-Davion's drive on the capital, but bad weather and heavy Loyalist resistance conspired to wipe out half of the attack force and scatter the rest to the four winds. Then-Leftenant Schoknecht took charge of the survivors and fought hard for eighteen exhausting hours before finally destroying the anti-air batteries near Portland, allowing the rest of the Lancers to land safely. For his courage under fire, he was rewarded with command of the Lancers' third battalion.

**Demi-Precentor Nouandam Jodat:** Demi-Precentor Jodat is an aberration among fanatics. He was a part of the Word of Blake's first wave of assaults that began the Jihad, but as soon as he discovered undeniable proof of the Blakists' vicious warcrimes, he walked away, taking three like-minded MechWarriors and the *Leopard*-class *Waterly's Shrike* with him. They and their black machines were last seen on Dieron, combating their former Blakist brethren with their own holy fire.

Type: **Cicada**

Technology Base: Inner Sphere

Tonnage: 40

Battle Value: 812

### Equipment

Internal Structure:

Engine:

Walking MP:

Running MP:

Jumping MP:

Heat Sinks:

Gyro:

Cockpit:

Armor Factor:

	320 XL	Mass
		4
		11.5
	8	
	12	
	0	
	10 [20]	0
		4
		3
	64	4

	Internal Structure	Armor Value
--	--------------------	-------------

Head	3	9
Center Torso	12	11
Center Torso (rear)		6
R/L Torso	10	6
R/L Torso (rear)		3
R/L Arm	6	4
R/L Leg	10	6

### Weapons

#### And Ammo

Medium Laser

CASE

Ultra AC/5

Ammo (Ultra) 20

Medium Laser

Small Pulse Laser

	Location	Critical	Tonnage
	RT	1	1
	RT	1	.5
	LT	5	9
	RT	1	1
	LT	1	1
	CT	1	.5

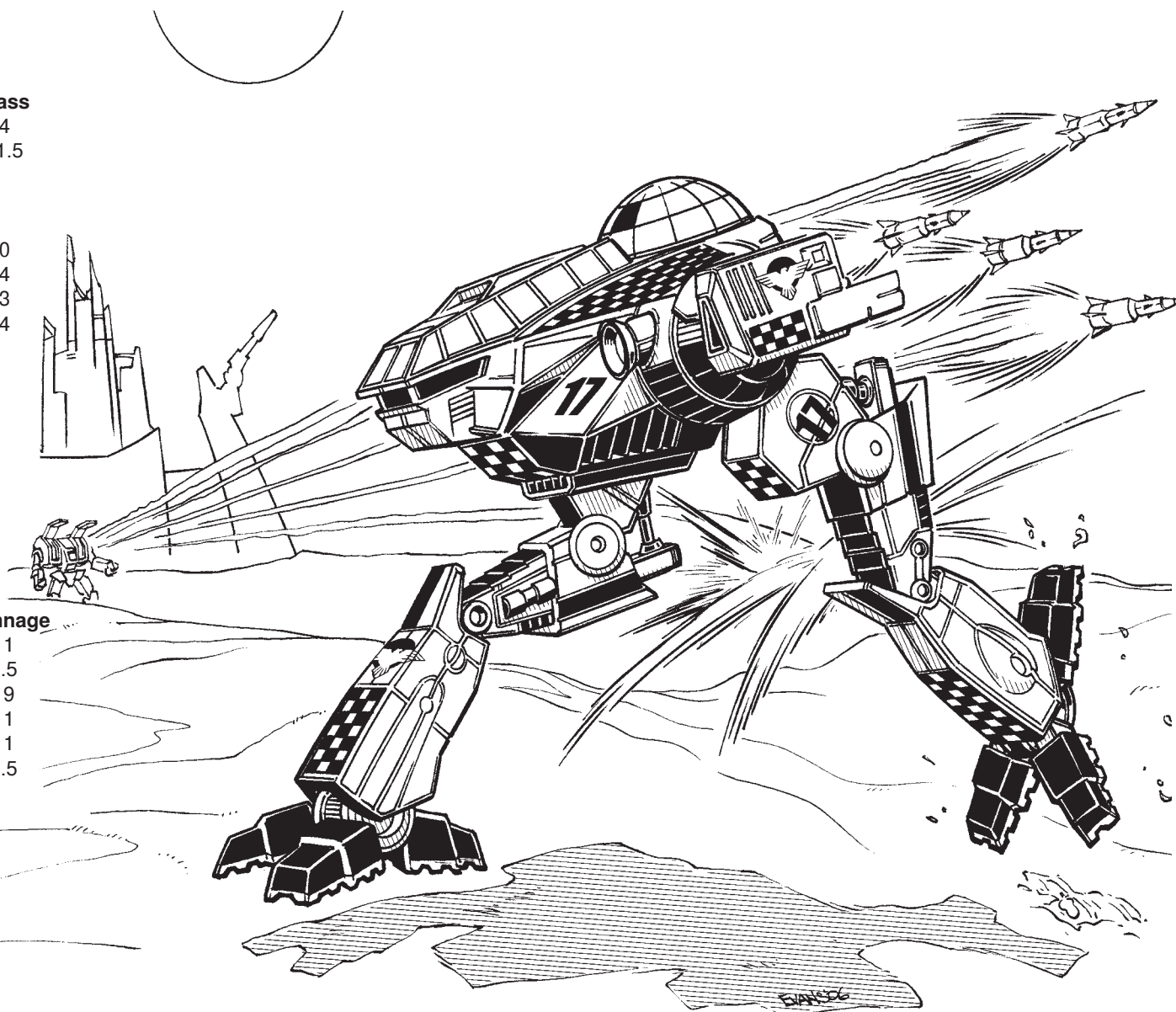

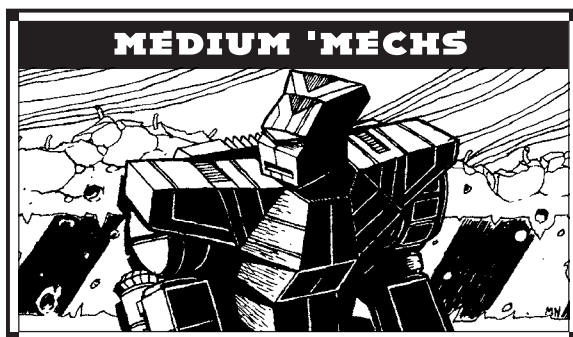

**Mass:** 40 tons

**Chassis:** Andoran Model III

**Power Plant:** Pitban 240

**Cruising Speed:** 64 kph

**Maximum Speed:** 97 kph

**Jump Jets:** Andoran Model JJII

**Jump Capacity:** 180 meters

**Armor:** Durallex Medium

**Armament:**

1 Magna Firestar Extended-Range PPC

2 Magna 400P Medium Pulse Lasers

**Manufacturer:** Andoran Industries Ltd.,

Defiance Industries

**Primary Factory:** Bell (Andoran),  
Furillo (Defiance)

**Communications System:** Raldon R1

**Targeting and Tracking System:** Sloane 220  
Lockover System

## Overview

In 2607, the SLDF commissioned the *Clint* from Andoran Industries, Limited, a minor BattleMech firm on Bell, which secured its bid for the new design with cost-cutting design features. Although the resulting design would prove flawed, well over 300 were built before the fall of the Star League and the destruction of Andoran's factories. Yet despite difficult maintenance that should have rendered the machine extinct long before then, an estimated 200 *Clints* remained in service by 3052, many scattered along FedSuns border regions and Capellan armies.

## Capabilities

The CLNT-2-3U upgrade package was simple: replace the Armstrong autocannon/5 with a more potent and enduring battlefield weapon. Upgrading to double-strength heat sinks and trading in the Armstrong for a Magna Firestar ER PPC, Bell accomplished both feats in short order and found enough tonnage to upgrade the *Clint's* original medium lasers with pulse models. These upgrades resulted in a machine that ran somewhat hotter but was much more deadly in combat.

## Deployment

Originally designed by the Capallans, the 3U *Clint* refit was later adopted by FedCom forces in the mid-3050s with the opening of the Bell Refit Yards—a minor salvage and repair company built on the remains of the original Andoran Industries factory complex. Specs for this design subsequently found their way to Defiance Industries of Furillo, which produced new *Clints* for the first time in centuries with a batch of 3Us in 3055. The FedCom's fragmentation led to the 3U's dispersion through the LAAF and mercenaries, and it was soon thereafter that Defiance released the 5U model, which saw action during the Civil War. More curious was the recent rise of 3T model, traced to factories in the Taurian Concordat.

## Variants

When first produced for the SLDF, the original *Clint* model—the CLNT-1-2R—lacked jump capability, but carried a heavier Armstrong Buster AC/10 and a single medium laser. Chassis stress and other flaws led to the production of the CLNT-2-3T that survived the Succession Wars so well. The 3T model carried two standard Martell medium lasers and an Armstrong autocannon/5.

On the eve of the FedCom Civil War, the LAAF introduced its newer and far more potent CLNT-5U, which used a Defiance-made light fusion engine and an endo-steel frame to free up weight for a weapons upgrade. This model traded the ER PPC for a Maxell ER large laser and dropped the pulse lasers in favor

of a trio of ER mediums, with room to spare for a TAG system and a C<sup>3</sup> slave.

With the onset of the Jihad and the stunning fall of Defiance's main factories on Hesperus II, Defiance of Furillo has gone into a frenzy of production and development, the fruits of which include the latest *Clint* variant, dubbed the CLNT-6S. This model takes the 5U and drops its jump jets in favor of a larger 280-rated light fusion plant. A small cockpit and heavy ferro-fibrous armor further lighten the machine's load enough to allow for the addition of a second Maxell, while the removal of the TAG, C<sup>3</sup> slave, and one of the medium lasers has allowed for the addition of a head-mounted small laser, creating a scout 'Mech that is faster and more durable than the original.

At roughly the same time the 6S entered service, reports began to circulate of another upgraded variant appearing in Taurian forces along the FedSuns border. These versions—clearly based on the original 3T model—have been dubbed the CLNT-3-3T series, and make use of ferro-fibrous armor and a light autocannon/5 in place of the original Armstrong. The weight savings from the light AC—presumably supplied to the Taurians by the Word of Blake—has even enabled its designers to add CASE protection for its ammunition, making the Taurian *Clints* much more durable in battle.

## Notable MechWarriors

**Hauptmann Janos Arthur Denton V:** The last survivor of a long and distinguished line who rose to fame in the Succession Wars with the family *Clint*, Denton was last seen with the Seventeenth Arcturan Guards on Small World just before the outbreak of the Jihad. Given the shattered state of the Guard at the time, it remains unlikely that Denton survived the Word's assault on that planet, but a venerable *Clint*—operating in the 5U configuration that Denton's family machine was allegedly last upgraded to—has been reportedly seen sporting the letters "JAD" on its left forearm and engaging Blakist occupation forces on behalf of the Small World Resistance.

# CLNT-2-3U CLINT

Type: **Clint**

Technology Base: Inner Sphere

Tonnage: 40

Battle Value: 1,081

## Equipment

Internal Structure:

Engine: 240

Walking MP: 6

Running MP: 9

Jumping MP: 6

Heat Sinks: 10 [20]

Gyro: 3

Cockpit: 3

Armor Factor: 72

## Mass

4

11.5

	Internal Structure	Armor Value
--	--------------------	-------------

Head	3	9
------	---	---

Center Torso	12	11
--------------	----	----

Center Torso (rear)		4
---------------------	--	---

R/L Torso	10	6
-----------	----	---

R/L Torso (rear)		4
------------------	--	---

R/L Arm	6	6
---------	---	---

R/L Leg	10	8
---------	----	---

## Weapons and Ammo

	Location	Critical	Tonnage
--	----------	----------	---------

ER PPC	RA	3	7
--------	----	---	---

Medium Pulse Laser	CT	1	2
--------------------	----	---	---

Medium Pulse Laser	LT	1	2
--------------------	----	---	---

Jump Jets	RT	2	1
-----------	----	---	---

Jump Jets	LT	2	1
-----------	----	---	---

Jump Jet	RL	1	.5
----------	----	---	----

Jump Jet	LL	1	.5
----------	----	---	----

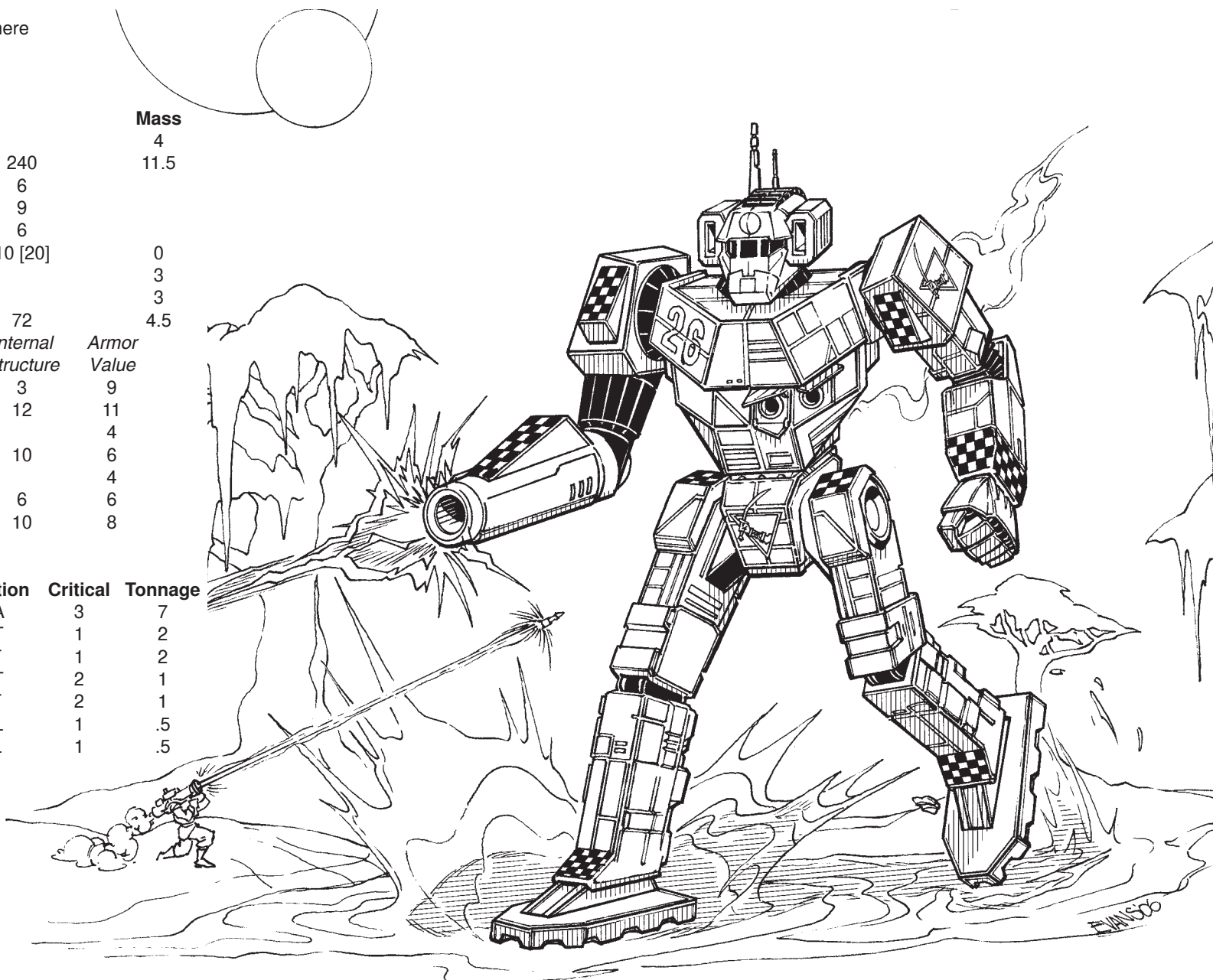

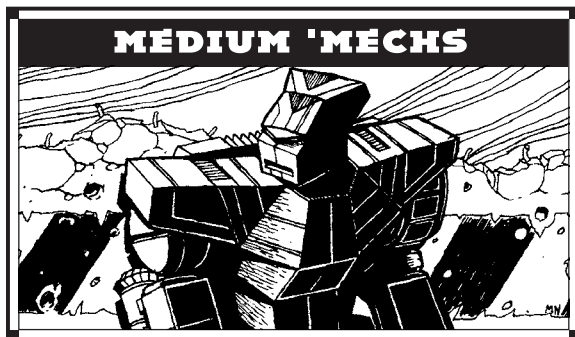

**Mass:** 40 tons

**Chassis:** Irian Second Generation Class 40 Endo Steel

**Power Plant:** Hermes 240

**Cruising Speed:** 64 kph

**Maximum Speed:** 97 kph

**Jump Jets:** None

**Jump Capacity:** None

**Armor:** Riese-456

**Armament:**

1 Imperator Ultra AC/5

1 Olympian Flamer

1 Intek Medium Pulse Laser

**Manufacturer:** Irian BattleMechs Unlimited

**Primary Factory:** Irian, Shiro III

**Communications System:** Irian E.A.R.

**Targeting and Tracking System:** Wasat Aggressor

## Overview

Having remained in production throughout the Succession Wars (unlike its sibling, the *Hermes I*) the *Hermes II* has established itself in the forces of the Free Worlds League, becoming one of the League's signature designs in the medium category. With the *Hermes* having lost much of its advanced technology during the centuries of war but retaining many of the Star League schematics, Irian BattleMechs Unlimited made the design one of its first lostech upgrades at its Irian plant.

## Capabilities

Using the classic Star League-era plans as a base but adding numerous innovations of its own, Irian rebuilt the *Hermes II* from the ground up while developing

the 5S model. A light endo-steel skeleton greatly reduces the chassis mass, allowing significant upgrades to the weaponry and heat management systems. An Imperator Ultra-5 Autocannon and an Intek medium pulse laser replace the original armaments—only the Olympian flamer remains from the 2S configuration—greatly improving accuracy and firepower. While upgrading the heat sinks to use double-efficiency polymers was met with some skepticism as heat management was rarely an issue with the older model, the change has allowed pilots of the 5S to redline their machines, using their full maneuverability and weapons array even after significant engine damage.

## Deployment

The FWLM has employed the upgraded *Hermes II* as a combination recon/light strike platform, exploiting its combination of speed and armor to carry out missions for which lighter designs are too fragile or heavier models too unwieldy. In such cases, the *Hermes II* often operates alone, relying on the pilot's skill and the machine's speed to avoid difficult engagements. In the light strike role the *Hermes II* is regularly paired with designs like the *Vulcan* and *Phoenix Hawk*, designs with a similar performance profile, though sometimes it is used as the "rabbit" for slower but heavier armed designs like the *Hunchback* or *Centurion*, luring enemies into its lancemates' killing zone. The largest concentration of the design is in the Free Worlds Guards, but the design has percolated down to most FWLM units though the League's massive upgrade program. Unfortunately, this has meant a large number fell into the hands of the Word of Blake through their suborning of Free Worlds forces.

Most other Inner Sphere powers employ the upgraded *Hermes II* to some degree, mainly as a result of exports after the Outreach Accords, using it as a general purpose BattleMech. The design's flexibility and reliability—field maintenance is among the easiest of all designs in its weight class—have earned the *Hermes II* the nickname "old reliable."

## Variants

Irian has produced a number of *Hermes II* variants over the years, some bolstering defensive capabilities while others focusing on armament upgrades. The

"Mercury Elite" variant (5ME) employed by the Dark Shadows replaced all the weapon systems with a light Gauss rifle, increasing the ammunition capacity to two tons at the expense of armor. Despite this, protection is boosted on the Elite by utilizing advanced ferro-fibrous composites instead of the Riese-456 laminate.

Variants of the *Hermes II* used by House Davion's Light Guards (the 6D) are less radical in their modifications, replacing the pulse laser with an extended-range variant and swapping the Ultra-AC for a rotary AC equivalent.

The Blakist variant—the HER-5C—bears only a passing resemblance to the standard model, employing an ER large laser in lieu of the autocannon and a trio of ER medium lasers. It also mounts an XL engine, using the freed up mass to add C<sup>3</sup>i and iNarc.

As with the CDA-3MA *Cicada*, the HER-5SA is a "training variant," commissioned by the Legionary Training Academy. The 5SA mounts an XL engine, which allows it to upgrade from a medium pulse laser to a large pulse laser, while increasing armor protection. Such an extravagance for an academy has only fueled the controversy surrounding the Legionary Training Academy and its unabashed political connections to the Captain-General.

## Notable MechWarriors

**Captain Bernard Ryan:** SAFE's Dark Shadows battalion moved into the open somewhat during the reign of Thomas Marik but despite this, the unit has maintained its reputation as an elite paramilitary formation thanks to the syndicated "memoirs" of a warrior known as Bernard Ryan (a pseudonym; even the author's gender is unclear, leading some to suggest that Colonel McCormack is behind the stories). These diaries provide a semi-fictional insight into life in the Dark Shadows and the operations it has been employed in, including several in which Ryan has fought in an upgraded *Hermes II* against enemies of the state. Until recently apolitical and somewhat gung-ho, the last year has seen Ryan take a more political stance, denouncing the coup on Atreus and the Blakist occupation. Ryan has steered clear of vilifying Captain-General Corinne Marik, but her father and several prominent figures in the administration have been the target of his invective.



# HER-5S HERMES II

Type: **Hermes II**

Technology Base: Inner Sphere

Tonnage: 40 tons

Battle Value: 857

## Equipment

Internal Structure:	Endo Steel	2	<b>Mass</b>
Engine:	240	11.5	
Walking MP:	6		
Running MP:	9		
Jumping MP:	0		
Heat Sinks:	10 [20]	0	
Gyro:		3	
Cockpit:		3	
Armor Factor:	120	7.5	

	Internal Structure	Armor Value
Head	3	9
Center Torso	12	17
Center Torso (rear)		6
R/L Torso	10	14
R/L Torso (rear)		5
R/L Arm	6	11
R/L Leg	10	14

## Weapons and Ammo

	Location	Critical	Tonnage
Ultra AC/5	RT	5	9
Ammo (Ultra) 20	LT	1	1
Flamer	LA	1	1
Medium Pulse Laser	RA	1	2

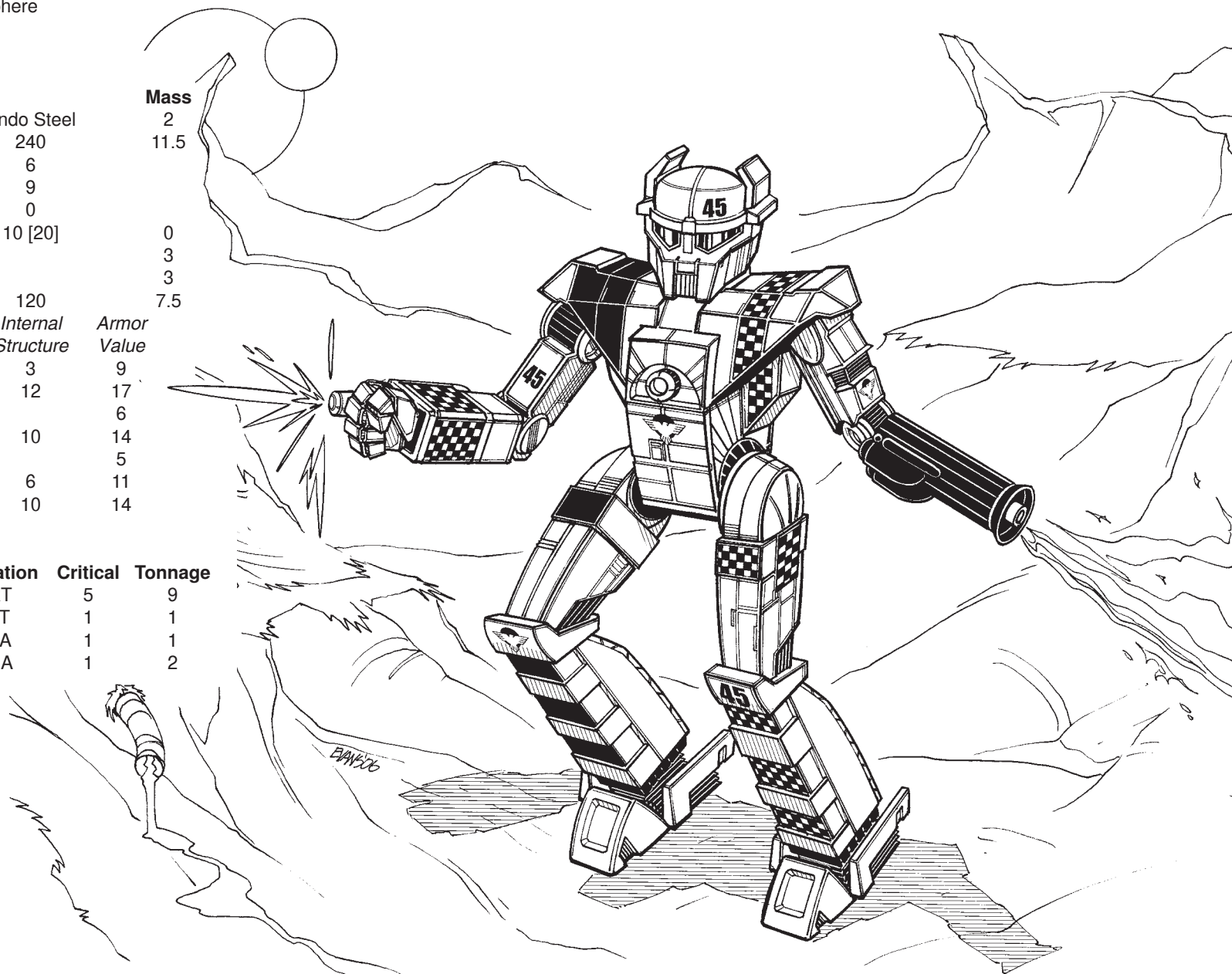

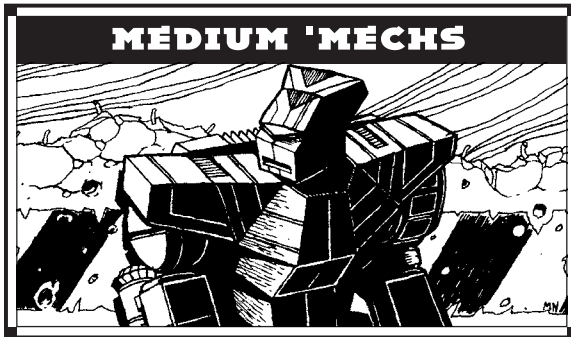

**Mass:** 40 tons

**Chassis:** Crucis-II Delux Endo Steel

**Power Plant:** Pitban 240

**Cruising Speed:** 64 kph

**Maximum Speed:** 97 kph

**Jump Jets:** Rawlings 75

**Jump Capacity:** 180 meters

**Armor:** Kallon Royalstar

**Armament:**

1 Tronel PPL-20 Large Pulse Laser

1 Tronel XII Medium Pulse Laser

1 Flame Tech Flamer

**Manufacturer:** Nimakachi Fusion Products Ltd.

**Primary Factory:** Tematagi (destroyed 3069)

**Communications System:** Omicron 4002

Networking Channel

**Targeting and Tracking System:** TRSS Eagle Eye

## Overview

Built for General Aleksandr Kerensky's troops in the last years of the Amaris Coup, the Free Worlds League captured the *Vulcan's* design specifications during the First Succession War. In need of new weapons to deal with the threat posed by the Lyran Commonwealth and Capellan Confederation, Parliament awarded the spoils of war to Nimakachi Fusion Products Ltd.

More recently, Nimakachi used recovered Star League technology to create the VT-5M in a bid to make the *Vulcan* more effective against other 'Mechs. After producing a limited production run of the upgraded design in 3052, Nimakachi scaled up production to produce twenty a month until their Tematagi production plant was destroyed in 3069.

## Capabilities

Since the *Vulcan* was already prized as an effective city fighter and anti-infantry 'Mech, Nimakachi retained the flamer and machine gun. Over the preceding three centuries the Armstrong autocannon's performance as the *Vulcan's* primary anti-'Mech weapon had been disappointing. Nimakachi engineers replaced the weapon with a Tronel PPL-20 large pulse laser. A powerful weapon, its short range was not considered a weakness in a 'Mech intended to operate against infantry or in an urban environment. At the same time the Randell medium laser was swapped out for a Tronel XII medium pulse laser, and the single heat sinks were replaced with eleven double-efficiency versions. The use of an endo-steel internal structure offset the extra weight of the new weaponry.

## Deployment

Often charged with dealing with civil unrest within the Free Worlds League, the Marik Militia has always had a place in their ranks for the *Vulcan*.

The Word of Blake Militia purchased *Vulgans* from Nimakachi as it was building up forces for Operation Odysseus—the capture of Terra in 3058. The Blakists found the 'Mech extremely useful for supporting operations to root out the last stubborn pockets of resistance. Several of these 'Mechs have since been transferred to the new Protectorate Militia, where they are an invaluable asset for policing the cities of the Blakist Protectorate. Additional *Vulgans* were captured when the Blakists sacked the Nimakachi factory on Tematagi.

During the FedCom Civil War, Coventry fell to Victor Steiner-Davion's Allied troops. The output from Coventry Metal Works was vital to Victor's forces during the early phases of the civil war, and the *Vulcan* was soon a common sight in the Allied ranks.

## Variants

Coventry Metal Works took a different approach in upgrading the Lyran-produced *Vulcan*. The VL-5S is armed with an Emperor Ultra-5 autocannon, and the armor has been upgraded to Lexington Ltd. High Grade Ferro-Fibrous Armor with CASE. Myomer acceleration signal circuitry allows the Lyran *Vulcan* to move with sudden bursts of speed at strategic moments. These

modifications are made possible by the installation of an Edasich Motors 240 XL engine.

In 3070 Word of Blake technicians began modifying their *Vulgans* to operate as part of a C<sup>3</sup> network. Removing a heat sink and replacing the pulse lasers with ER versions, the VT-6C mounts a C<sup>3</sup>i unit in the right torso. The old arm-mounted machine gun is replaced by three light machine guns linked together into a single array.

Before its destruction, Nimakachi further upgraded their production line to produce an improved design. Using a 240 XL engine, the VT-6M *Vulcan* replaced the pulse lasers with a light Gauss rifle and an extended-range medium laser. With two tons of ammunition, the Gauss rifle has a generous thirty-two round magazine. Over five tons of StarSlab/1d light ferro-fibrous armor provided improved protection, especially on the arms. Less than three dozen of this variant came off the production line, and most were captured by the Blakists when they destroyed the factory.

## Notable MechWarriors

**Meredith Hyde:** With a fiery and often violent temper, Hyde has a deep hatred for the Free Worlds League. After being dismissed from the Fusiliers of Oriente, Wommel Hyde, Meredith's father, was forced into exile, ultimately finding service with the infamous Redjack Ryan. Growing into an old and bitter man, Wommel instilled in his daughter a thirst to avenge all the slights (real or imagined) that an ungrateful League had piled upon him. Trained by her father, Hyde's natural talent more than compensated for a lack of formal education. Cunning and treacherous, she may quit the field when overmatched, but against a Marik opponent she will spend inordinate amount of time and effort to ensure their ultimate downfall.

Recruited by the Word of Blake, Hyde was part of the force that leveled the Nimakachi plant on Tematagi. As a reward, her employers awarded her a captured *Vulcan*.

# VT-5M VULCAN

Type: **Vulcan**  
 Technology Base: Inner Sphere  
 Tonnage: 40  
 Battle Value: 811

## Equipment

Internal Structure:	Endo Steel	2	Mass	11.5
Engine:	240	6		
Walking MP:	6	9		
Running MP:	9	6		
Jumping MP:	6	11 [22]		
Heat Sinks:	11 [22]	1		
Gyro:		3		
Cockpit:		3		
Armor Factor:	80	5		

	Internal Structure	Armor Value
Head	3	8
Center Torso	12	10
Center Torso (rear)		6
R/L Torso	10	8
R/L Torso (rear)		4
R/L Arm	6	6
R/L Leg	10	10

## Weapons and Ammo

	Location	Critical	Tonnage
Large Pulse Laser	RT	2	7
Medium Pulse Laser	LT	1	2
Flamer	RA	1	1
Machine Gun	LA	1	.5
Ammo (MG) 200	LT	1	1
Jump Jets	CT	2	1
Jump Jets	LT	2	1
Jump Jets	RT	2	1

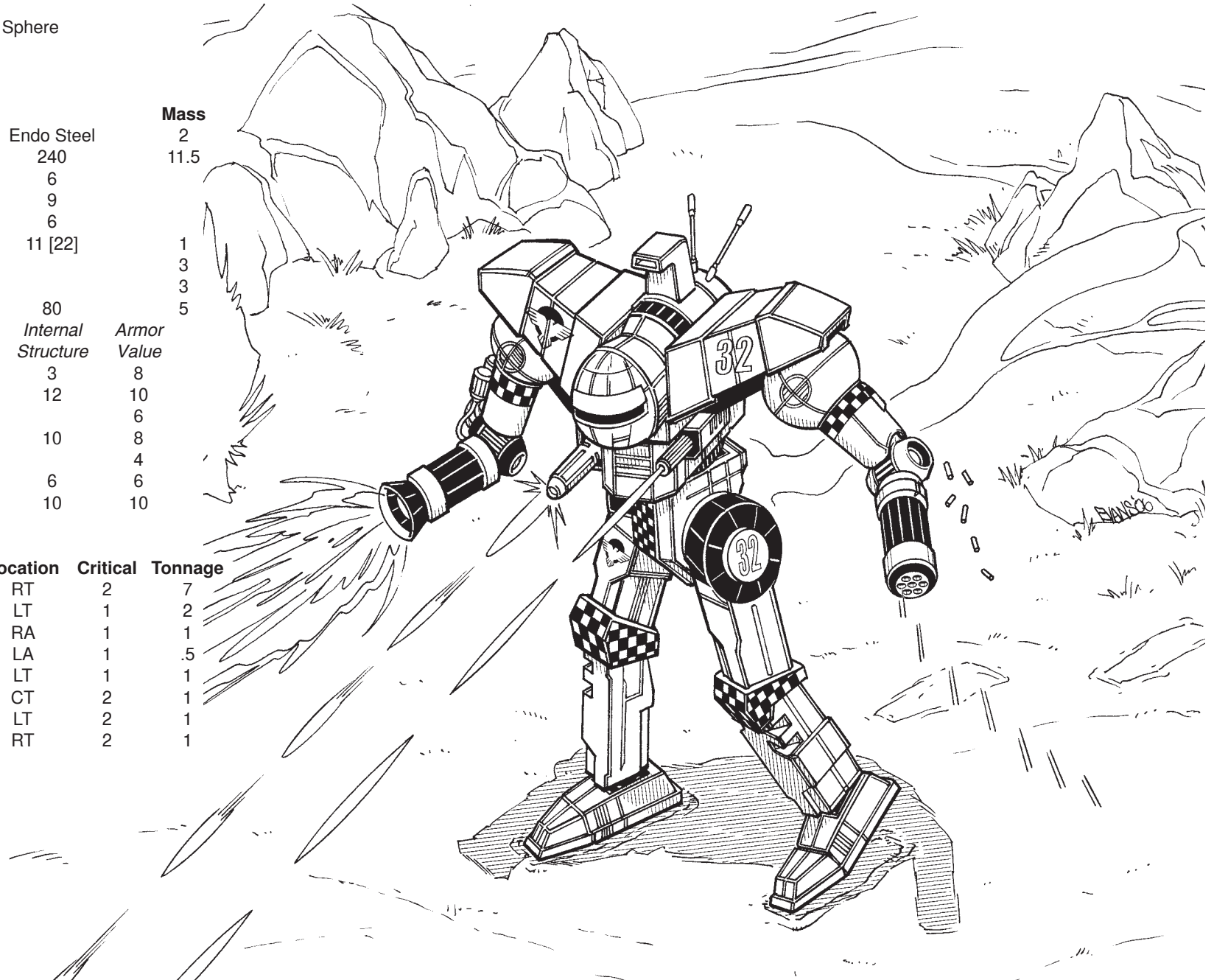

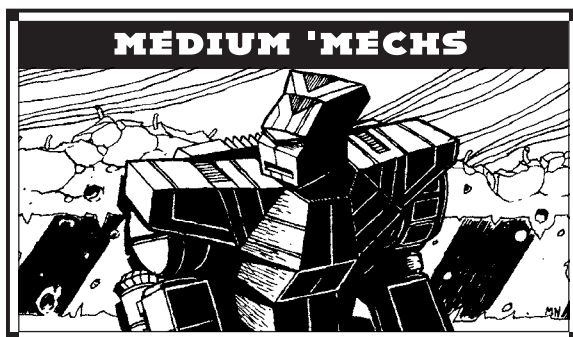

**Mass:** 40 tons

**Chassis:** Whitworth Type 1

**Power Plant:** LTV 160

**Cruising Speed:** 43 kph

**Maximum Speed:** 64 kph

**Jump Jets:** Whitworth Jetlift

**Jump Capacity:** 120 meters

**Armor:** Durallex Light

**Armament:**

2 Longbow-10 LRM Launchers

1 Intek Medium Laser

**Manufacturer:** Whitworth Specialty Manufacturing

**Primary Factory:** Benjamin (upgrades only)

**Communications System:** Garret T14

**Targeting and Tracking System:** Garret D2j with  
Artemis IV FCS

## Overview

The *Whitworth* was initially designed as a light-weight missile support platform, ideally used with medium fire lances or artillery units. The *Whitworth* was marginally successful in these roles; newer designs are able to carry out similar mission profiles but with more mobility. With the *Whitworth's* primary factory on Dieron destroyed during the Amaris Crisis, no attempt by any BattleMech firm has been made to reproduce such a mediocre platform. Only the Whitworth Specialty Manufacturing company actually does upgrades to these BattleMechs; they are currently under exclusive contract to the DCMS to refit a stockpile of older WHT-1s.

Due to the disdain they receive (most Suns and Combine warriors have nicknamed the design the

“Worthless”), most *Whitworths* were decommissioned from the active Great House militaries after the mid-3050s. Still sold by brokers to mercenary companies and Periphery forces, the *Whitworth* has become a rare sight on today’s battlefield. Only with the ravaging fires of the Jihad has the *Whitworth* begun to find some new life with battlefield upgrades.

## Capabilities

The *Whitworth* served with distinction during the Succession Wars, providing much-needed long-range support for recon and strike lances. However, because most MechWarriors like their battles up-close and personal, the design faltered due to poor armor distribution, weak leg joints, and low ammo loads for the long-range missiles. An attempt after the Clan Invasion tried to rectify the situation with field kits that installed Artemis Fire Control Systems, which worked well as an artillery support unit but still kept more aggressive pilots from getting down and dirty.

With the recent destruction of the Jihad, both Suns and Combine forces are incorporating patchwork field upgrades in order to combat the Blakist’s improved C<sup>3</sup> technology. While not widespread, these two new variants are finding their way into combined arms units to provide additional fire support.

## Deployment

Older *Whitworths* can be found among Taurian, Alliance, and pirate forces along the spinward side of the Inner Sphere, some retrofitted with rocket pods to replace damaged launchers. Because of the decommissioning of these units before 3060, a large glut of them hit the salvage market and was snapped up by smaller nations and mercenary units looking to beef up their forces with minimal cost. Most of the *Whitworths* seen among Suns and Combine forces utilize new upgrade packages.

## Variants

The most common new upgrade of the *Whitworth* found among the Capellan March forces utilizes a C<sup>3</sup> slave to connect to a full network. Four LRM-5 packs (with ample ammunition) provide light fire support, though lately this design has been relegated to clearing the frequent minefields the Confederation loves to lay.

The mobility of this variant—tagged the “WHT-3”—is greatly improved, with the installation of GM’s StarLift Improved Jump Jets.

More intriguing is the Combine variant, which also incorporates a C<sup>3</sup> slave. However, the inclusion of two MML-7 systems caters to the warrior’s personal fighting style, allowing both long-range fire support and close-combat firepower. Five QuestStar improved jump jets give the design deadly mobility, especially among urban environments.

A further variant that first appeared in the Marian Hegemony replaces the LRM-10s with an SRM 6-rack and eight rocket launcher-10s. Once considered little more than a minor threat, the WHT-1H is a feared sight on Periphery battlefields.

Lastly, reports of variants utilizing an endo-steel chassis and dubbed the WHT-2A have surfaced in recent years. The design sports four SRM Streak-4s, a C<sup>3</sup> slave unit, and two mediums with a single small laser, and at this point it is unknown whether these are custom refits or actually new production models.

## Notable MechWarriors

**Lieutenant Tomas Hughes:** Head of GM-Kathil’s security force, Hughes was one of the first to test the new StarLift jets on a *Whitworth* platform. Able to extend the ‘Mech’s jump range by an additional 60 meters, Hughes easily managed to move around a mock urban “playground.” After having worked with that particular *Whitworth* for several months, the GM team permanently assigned it to him and his C<sup>3</sup>-equipped company in 3068.

**Yosi:** Known only by his first name, Yosi was commander of the Tortugan pirates’ fire lance when Lady Death came calling in late 3067. Yosi and his small lance of medium-weight ‘Mechs managed to lure Trevalline’s command lance into three separate ambushes, not an easy feat. When the Tortugans finally surrendered, Lady Death purportedly sought out the “bastard who suckered me three times” and promptly made him her chief tactician. Since then, Yosi has laid several successful ambushes against Taurian forces during the pirate’s constant raiding along the Concordat’s border.

# WHT-2 WHITWORTH

Type: **Whitworth**

Technology Base: Inner Sphere

Tonnage: 40

Battle Value: 936

## Equipment

Internal Structure:

Engine: 160  
 Walking MP: 4  
 Running MP: 6  
 Jumping MP: 4

Heat Sinks: 10

Gyro: 2

Cockpit: 3

Armor Factor: 128

## Mass

4

6

0

2

3

8

*Internal  
Structure*    *Armor  
Value*

Head 3 9  
 Center Torso 12 16  
 Center Torso (rear) 7 7  
 R/L Torso 10 12  
 R/L Torso (rear) 6 6  
 R/L Arm 6 12  
 R/L Leg 10 18

## Weapons and Ammo

	Location	Critical	Tonnage
LRM 10	RT	2	5
Ammo (LRM) 12	RT	1	1
Artemis IV FCS	RT	1	1
LRM 10	LT	2	5
Ammo (LRM) 12	LT	1	1
Artemis IV FCS	LT	1	1
Medium Laser	H	1	1
Jump Jets	RL	2	1
Jump Jets	LL	2	1

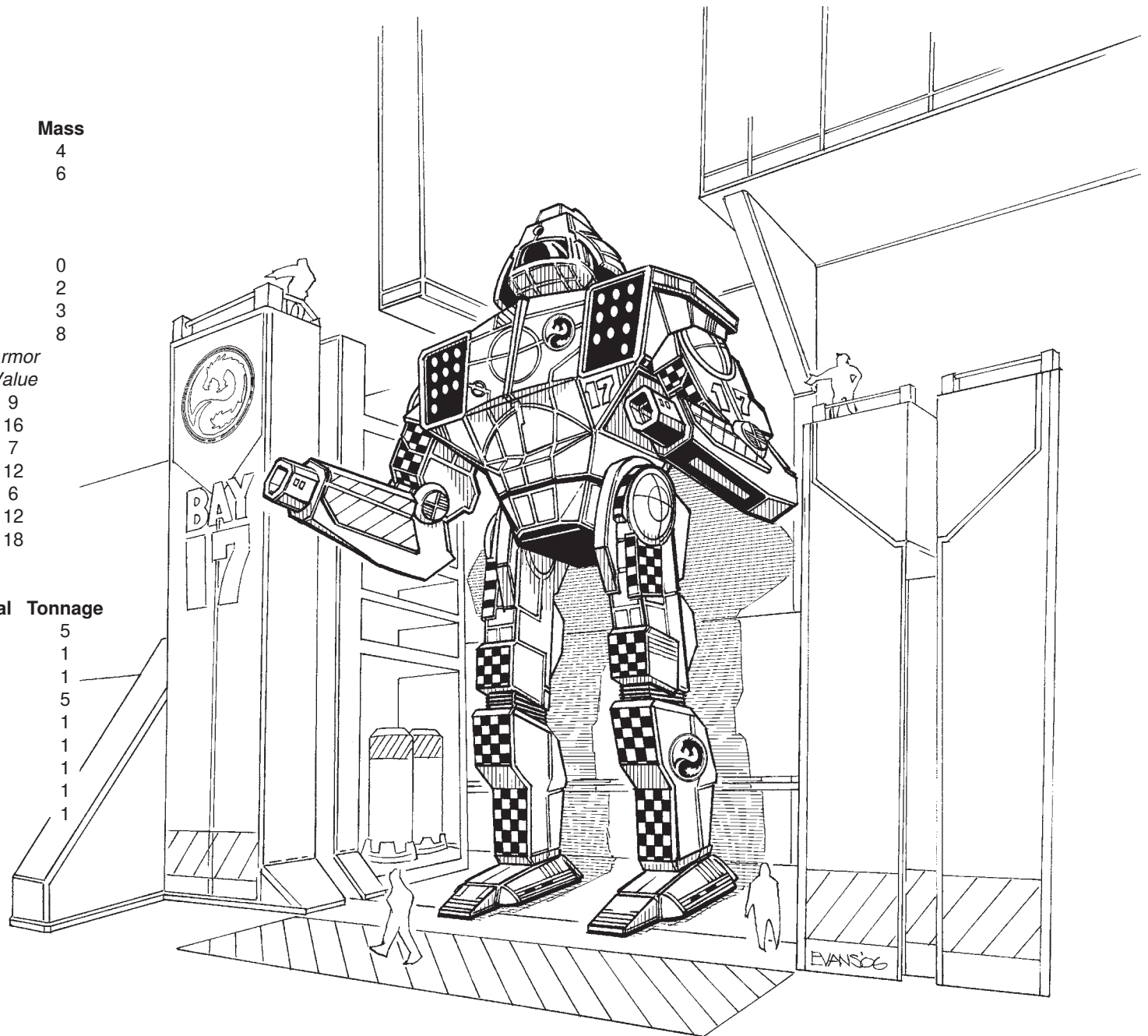

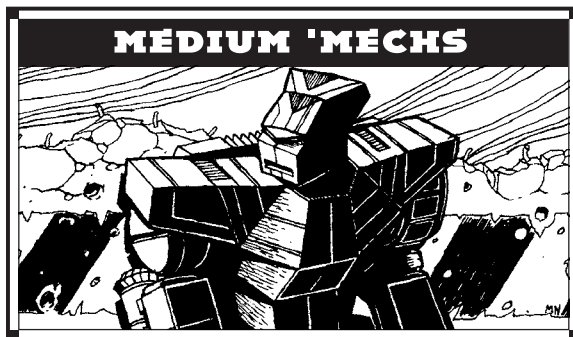

**Mass:** 45 tons  
**Chassis:** GM BJ-I  
**Power Plant:** GM 180  
**Cruising Speed:** 43 kph  
**Maximum Speed:** 64 kph  
**Jump Jets:** Whitworth Jetlift  
**Jump Capacity:** 120 meters  
**Armor:** StarGuard II  
**Armament:**

2 Diverse Optics Sunbeam Extended-Range  
Large Lasers  
4 Hovertec Streak SRM-2 Pods

**Manufacturer:** General Motors  
**Primary Factory:** Talcott  
**Communications System:** Dalban Micronics  
**Targeting and Tracking System:** Dalban AQ

## Overview

Developed by General Motors during the Star League-era, the *Blackjack* was intended to serve in an insurgency-suppression and fire-support role. Inexplicably bedeviled with claims that the basic design was flawed and unstable, the 'Mech quickly fell into disfavor. Thus few mourned the destruction of the *Blackjack* production line on Kathil during the First Succession War.

While other nations all but abandoned the 'Mech, techs in the Federated Suns continued to tinker with it. In the process they discovered that the claims that the 'Mech's narrow footpads hampered mobility and stability were false. Fears that the StarGuard II armor was too brittle were similarly groundless. With Star League technology becoming available, techs experimented

with refitting the *Blackjack*. General Motors began to once more manufacture the design in limited numbers in 3054 when field trials of these experimental units produced promising reports.

## Capabilities

Originally one of several experimental models, the BJ-2 became the blueprint for both the AFFC standard field upgrade and the version being manufactured on Kathil. Firepower was enhanced at the cost of range by replacing the Whirlwind autocannon with Diverse Optics Sunbeam extended-range large lasers. Four Hovertec Streak SRM-2 pods and a ton of ammunition replaced the medium lasers. The heat sinks were upgraded to double-efficiency models after earlier test units reported serious heat problems.

With many MechWarriors continuing to hold the *Blackjack* in contempt, the upgraded 'Mech often surprises opponents with heavy and accurate fire. The new weapons mix has also proven itself effective against battle armor.

## Deployment

Common only in Davion and Liao space, the *Blackjack*'s poor reputation relegated it to service in militia formations in the Federated Suns. This began to change following the fighting on Xhosa at the end of the Third Succession War. With the introduction of the upgraded version, the *Blackjack* has begun deployment with the Avalon Hussars and Deneb Light Cavalry.

The St. Ives Compact deployed their BJ-3 variant extensively with their St. Ives Armored Cavalry, and a number of BJ-3s entered service with Federated Commonwealth troops stationed in the Compact.

## Variants

Produced on St. Ives, the BJ-3 replaces the AC/2s with Ceres Arms Smasher PPCs and retains the medium lasers. Although one heat sink is removed, the ten that remain are upgraded.

Another Federated Suns creation, the BJ-4 entered production during the FedCom Civil War. It mounts two light class-5 autocannons with a CASE-protected forty round magazine in each torso. Two arm-mounted ex-

tended-range medium lasers ride sidecar with the autocannon, and all four weapons are tied into a sophisticated targeting computer in the left torso. A new 180 light power plant drives the 'Mech, and light ferro-fibrous armor provides the same level of protection with no additional weight cost.

## Notable MechWarriors

**Lieutenant Colonel Michael Ubodo:** Only an NAIS cadet when he became the hero of the battle on Xhosa VII during the Third Succession War, Ubodo was assigned to command a lance in the Eighth Deneb Light Cavalry RCT. Continuing to serve with the Eighth, he rose through the ranks, finally reaching the position of executive officer in the 'Mech regiment when Kommandant Jervais was killed during the defense of Blue Hole against the Jade Falcons.

A great proponent of the maligned *Blackjack*, Ubodo has piloted the "*Arrow*" since his victory on Xhosa VII. Refitted with new technology, Ubodo and his *Blackjack* held off several points of Elementals on a headhunter mission during the fighting on Blue Hole.

**MechWarrior John Hopewell:** A veteran MechWarrior formerly serving with the Eighth Syrtis Fusiliers, Hopewell contracted a terminal respiratory disease while participating in Duke Hasek's ill-conceived offensive against the Capellan Confederation. Traveling with a DropShip full of medical evacuees, Hopewell found himself stranded on Beid along with a lance from the Twentieth Avalon Hussars under the command of Lieutenant David McKinnon. When Word of Blake raiders attacked in late 3070, McKinnon rallied the walking wounded (Hopewell amongst them), forming them up along side his Hussars. Striking the Blakist flank, this ad-hoc demi-company inflicted heavy casualties and sent the raiders fleeing back to their DropShip.

Still a deadly warrior at the controls of his upgraded *Blackjack* (when he isn't coughing his lungs out), Hopewell has taken upon himself the role of McKinnon's bodyguard as their ramshackle force continues to battle the Blakists in the Capellan March.

# BJ-2 BLACKJACK

Type: **Blackjack**

Technology Base: Inner Sphere

Tonnage: 45

Battle Value: 1,148

## Equipment

Internal Structure:

Engine: 180

Walking MP: 4

Running MP: 6

Jumping MP: 4

Heat Sinks: 11 [22]

Gyro: 2

Cockpit: 3

Armor Factor: 136

	Mass	Armor Value
	4.5	
	7	
	1	
	2	
	3	
	8.5	
Internal Structure	Armor Value	
Head	3	9
Center Torso	14	18
Center Torso (rear)		9
R/L Torso	11	15
R/L Torso (rear)		6
R/L Arm	7	12
R/L Leg	11	17

## Weapons and Ammo

	Location	Critical	Tonnage
ER Large Laser	RA	2	5
ER Large Laser	LA	2	5
2 Streak SRM 2	LT	2	3
Ammo (Streak) 50	LT	1	1
2 Streak SRM 2	RT	2	3
Jump Jets	RL	2	1
Jump Jets	LL	2	1

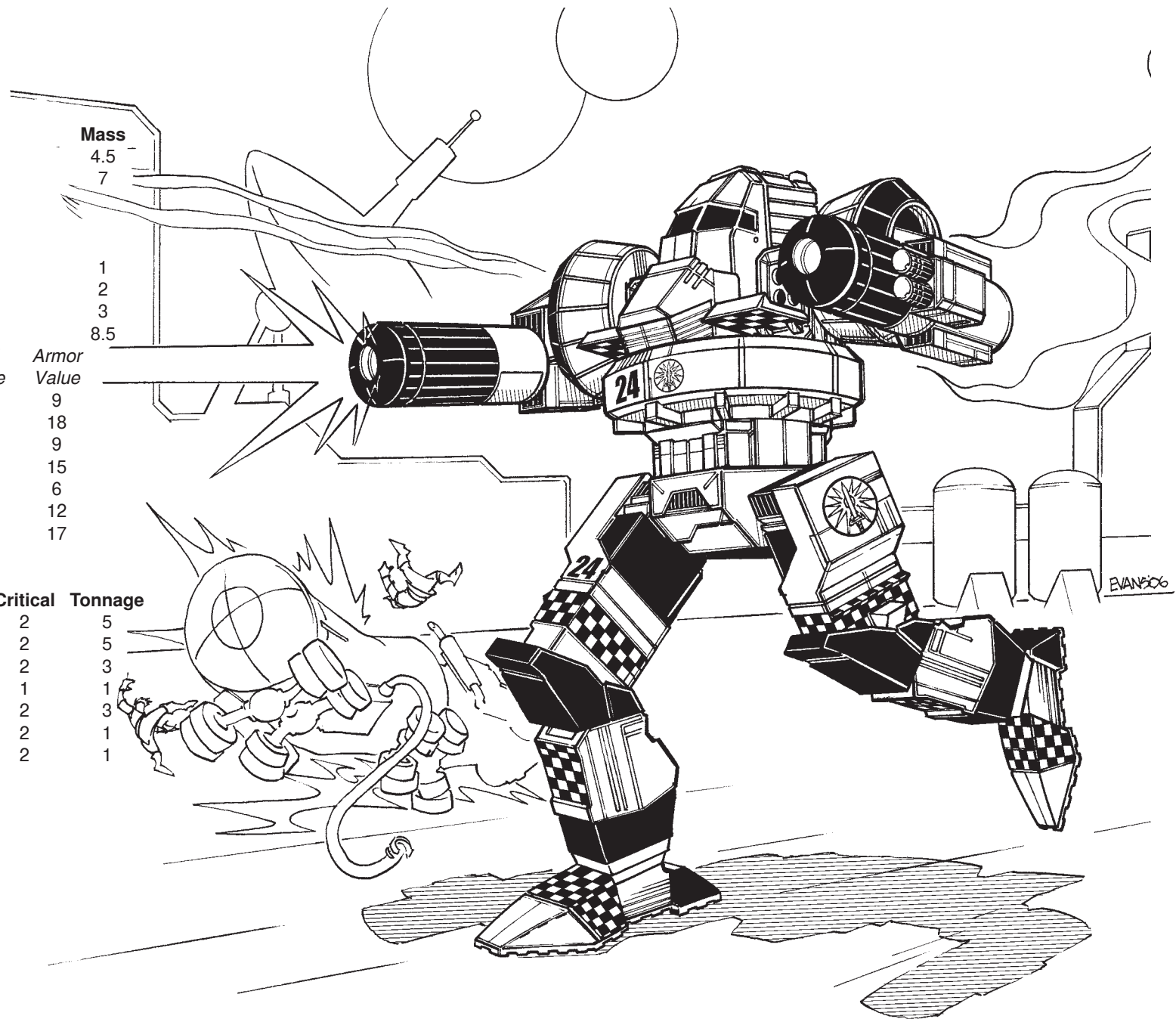

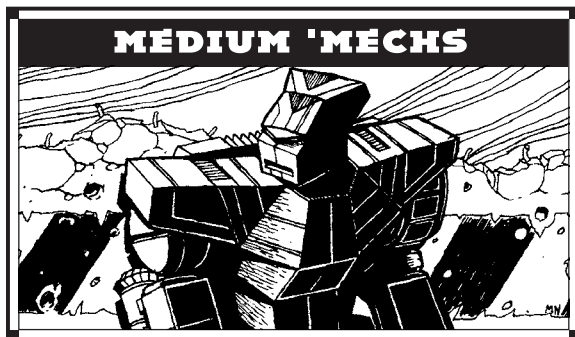

**Mass:** 45 tons

**Chassis:** Chariot Type II

**Power Plant:** Edasich Motors 180 XL

**Cruising Speed:** 43 kph

**Maximum Speed:** 64 kph

**Jump Jets:** Luxor 2/Q

**Jump Capacity:** 120 meters

**Armor:** Durallex Super Medium Ferro-Fibrous  
with CASE

**Armament:**

1 Defiance Disintegrator LB 10-X Autocannon

3 Defiance P5M Medium Pulse Lasers

1 Hatchet

**Manufacturer:** Defiance Industries, Johnston Industries

**Primary Factory:** Hesperus II (Defiance),  
New Syrtis (Johnston)

**Communications System:** TharHes Thalia HM-22

**Targeting and Tracking System:** TharHes Ares-8a

## Overview

Introduced in 3023, the *Hatchetman* was the first completely new BattleMech design to enter production in the Successor States in over a century. Quickly gaining acceptance in Lyran service, it became one of the Federated Commonwealth's standard 'Mechs. Faced with the increasing demand, Defiance Industries updated their Hesperus II assembly line to triple output and upgraded their design with recovered Star League technology. Even this proved insufficient, leading Defiance Industries to negotiate with Johnston Industries to manufacture the 'Mech in Davion space.

## Capabilities

By mounting an Edasich Motors 180 XL engine, Defiance Industries' engineers could upgrade both the *Hatchetman's* weaponry and armor. Replacing the primary weapon with a Defiance Disintegrator LB 10-X autocannon expanded the 'Mech's offensive envelope by twenty percent. While the decision to reduce magazine capacity met with criticism, increasing armor protection by almost fifty percent and adding CASE was certainly not. The arm-mounted lasers were replaced with new P5M pulse versions, with an additional P5M installed in the left torso. Combined with its trademark hatchet, the new weapons enhanced the *Hatchetman's* effectiveness as a city fighter, although continued reliance on older heat sinks requires MechWarriors to manage their heat levels with care.

The *Hatchetman's* full head ejection system has been incorporated into other designs, such as the *Wolfhound* and *Axman*. Despite their best efforts, Defiance Industries engineers have yet to come up with a satisfactory solution to the requirement that the 'Mech be ejected before the escape system is activated.

## Deployment

Selected as one of the AFFC's standard designs, the *Hatchetman* enjoyed widespread deployment across the Federated Commonwealth. Serving alongside *Valkyries*, *Enforcers* and *Dervishes*, the new version has seen combat on every front. Both LAAF and AFFS commands continue to deploy the design in significant numbers.

House Kurita succeeded in copying the *Hatchetman*, but the Samurai of the Draconis Combine considered the hatchet to be an uncouth weapon, and it has seen only limited deployment.

Mercenaries carried the old HCT-3F into the Taurian Concordat, where they were later integrated into the Pleiades Lancers. The sight of the *Hatchetman* in the ranks of the TDF triggered fears that spies had leaked the plans to Taurian Territorial Industries. Seizing upon this, the hopelessly paranoid Protector Thomas Calderon directed TTI to reverse engineer the *Hatchetman*. Hindered by repeated diversions of project funds, it was not until 3054 that the first homegrown HCT-3F came off production lines in any number. Bedeviled with technical problems, the Taurians nevertheless persevered

with production until TTI was demolished by the Fighting Urukhai in 3066.

## Variants

Using the latest technology, Johnston Industries have created the HCT-6D. Built on an endo-steel chassis, this is a faster 'Mech with a VOX 225 XL engine and extra jump jets. A Mydron Tornado RAC/5 and three Diverse Optics extended-range medium lasers can still tax its ten double heat sinks. The 6D is protected by over nine tons of armor and a Guardian ECM system but lacks CASE.

During the FedCom Civil War, Defiance Industries introduced the updated HCT-6S. Using a light power plant and double heat sinks, the 6S replaces the pulse lasers with extended-range units. Addressing the greatest criticism of the 5S, the autocannon magazine was expanded to carry twenty rounds.

Working from the remains of HCT-3Fs salvaged from the battlefield, the Draconis Combine created their own copy (albeit without the head ejection system). After the design failed to gain widespread acceptance, technicians at Independence Weaponry have tried to salvage the project. They have been experimenting with swapping the hatchet for a sword and replacing the autocannon with an MRM-30 launcher and two tons of ammunition in their HCT-5K variant. Utilizing nine tons of standard armor, the Combine design mounts double heat sinks and a C<sup>3</sup> slave unit. Like the upgraded Defiance version, the arm lasers have been replaced with pulse lasers, but the torso-mounted medium laser is an ER model.

## Notable MechWarriors

**Sergeant Major Austin Vorster:** In 3023 Vorster was called upon to assume the hereditary position in the command lance of the legendary Fox's Teeth following the death of his father. Over the years of heavy fighting that followed Vorster has built a formidable reputation and earned the respect of friend and foe alike.

During the FedCom Civil War, Vorster's *Hatchetman* proved invaluable in the close-quarter fighting on Horneburg. Luring much larger Loyalist 'Mechs into the industrial park on the outskirts of Castle Rock, the Sergeant Major used his 'Mech's trademark weapon to fell a *Zeus* and a *Banshee* that were foolish enough to attempt pursuit.



# HCT-5S HATCHETMAN

MEDIUM 'MECHS

49

Type: **Hatchetman**

Technology Base: Inner Sphere

Tonnage: 45

Battle Value: 1,039

## Equipment

Internal Structure:

Engine: 180 XL

Walking MP: 4

Running MP: 6

Jumping MP: 4

Heat Sinks: 10

Gyro: 2

Cockpit: 3

Armor Factor: 152

Internal Structure	Armor Value
--------------------	-------------

Head	3	9
------	---	---

Center Torso	14	21
--------------	----	----

Center Torso (rear)		6
---------------------	--	---

R/L Torso	11	16
-----------	----	----

R/L Torso (rear)		6
------------------	--	---

R/L Arm	7	14
---------	---	----

R/L Leg	11	22
---------	----	----

## Weapons and Ammo

	Location	Critical	Tonnage
--	----------	----------	---------

LB 10-X AC	RT	6	11
------------	----	---	----

Ammo (LB-X) 10	RT	1	1
----------------	----	---	---

CASE	RT	1	.5
------	----	---	----

Medium Pulse Laser	RA	1	2
--------------------	----	---	---

Medium Pulse Laser	LA	1	2
--------------------	----	---	---

Medium Pulse Laser	LT	1	2
--------------------	----	---	---

Hatchet	RA	3	3
---------	----	---	---

Jump Jets	RL	2	1
-----------	----	---	---

Jump Jets	LL	2	1
-----------	----	---	---

## Mass

4.5

3.5

0

2

3

8.5

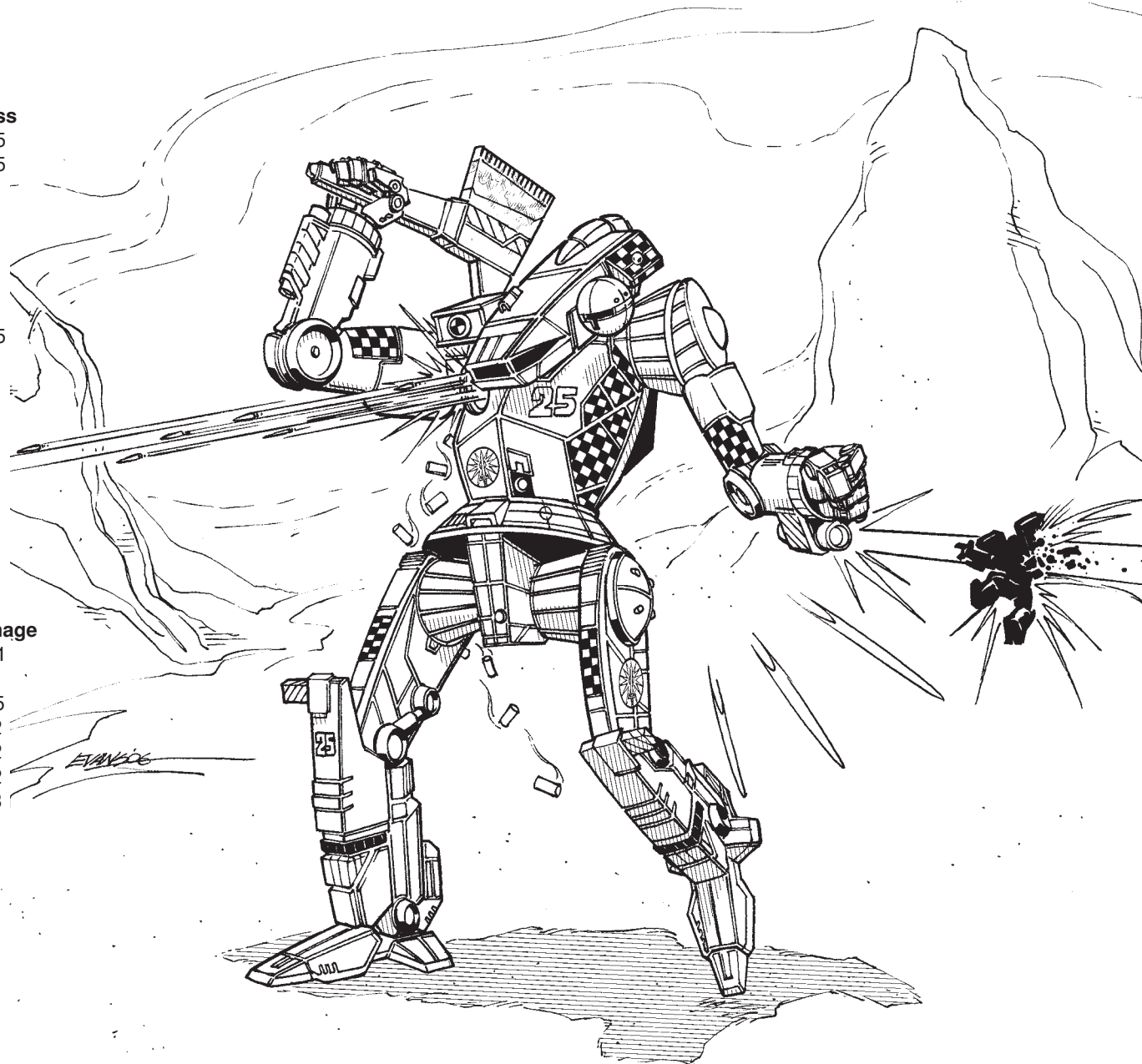

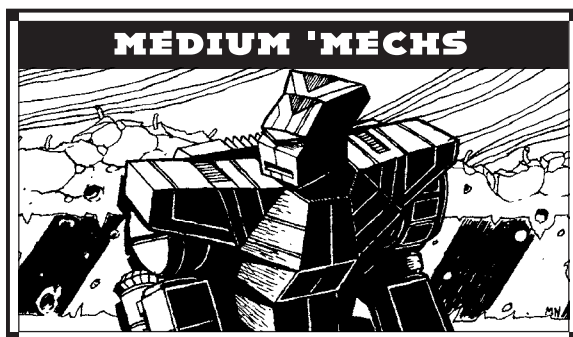

**Mass:** 45 tons

**Chassis:** Ceresplex IV

**Power Plant:** GM 180

**Cruising Speed:** 43 kph

**Maximum Speed:** 64 kph

**Jump Jets:** Anderson Propulsion 30

**Jump Capacity:** 120 meters

**Armor:** Starshield with CASE

**Armament:**

1 Sian/Ceres Jaguar LRM Missile System

1 Ceres Arms Warrior Extended-Range PPC

1 Ceres Arms Model W Medium Pulse Laser

**Manufacturer:** Ceres Metals Industries

**Primary Factory:** Capella

**Communications System:** CeresCom Model 21-Rs

**Targeting and Tracking System:** C-Apple Churchill

## Overview

With much of their military complex occupied by the Federated Commonwealth during the Fourth Succession War, few designs were still produced inside the Capellan Confederation. What meager resources Romano Liao had left were to be split around her battered realm, and her advisors often hotly debated amongst themselves what recommendations to make. However, they all agreed that a portion of these funds were to be used on what was quickly becoming the standard-issue medium BattleMech of the CCAF—the *Vindicator*.

## Capabilities

In order to save resources, designers avoided anything that would greatly increase the cost of their

inexpensive design, like advanced engines or a new chassis. Double heat sinks eliminated any threat of overheating, even with the upgraded medium pulse laser and ER PPC. CASE was added at the expense of the small laser, increasing the survivability from an ammunition explosion.

## Deployment

The production of the *Firestarter* OmniMech and its subsequent proliferation via the second Star League curtailed sales for the longtime workhorse of the Confederation. Fortunately, Ceres Metals was able to partially revive the line in 3060 with a close-combat version. The second, stealth-equipped version completed the rebirth, as the Capellans were desperate to add more common designs to their Shadow Lances.

On Liao, after the second beachhead by Word of Blake was established in Franco City, a skirmish between a Blakist patrol and a Shadow Lance probing the beachhead's perimeter became particularly brutal. The pair of 4L *Vindicators* held a street open while their two lance mates made their way behind enemy lines. As the Blakist patrol surrounded the pair of 4Ls, a lance of 5Ls arrived in support and engaged the Blakists, who had called for reinforcements, too. Though the lance of 5L *Vindicators* was destroyed, the entire Shadow Lance was able to get behind lines to conduct an extensive guerrilla campaign to disrupt supplies.

## Variants

Utilizing their perfected triple-strength myomer, Ceres Metals released a close-combat version, the 5L, with which the FS9-O *Firestarter* could not compete. The ER PPC is backed up by a bevy of lighter ER and pulse lasers, and the heat generated only increases the damage dealt by the sword mounted on the left arm. The 4L variant utilizes the popular stealth armor and increases the speed by installing a 225 XL fusion engine.

The latest variant attempts to combine both upgrades into one. The 6L model keeps the stealth armor, triple-strength myomer, and sword. The PPC is exchanged for a newly developed plasma rifle backed by a pair of extended-range medium lasers and slaved

to a targeting computer salvaged from destroyed Federated Suns machines. Two rocket launcher pods provided an additional punch during first contact situations. The necessity of salvage for its production has obviously made this variant extremely rare, as each are "handmade" and awarded to only the most heroic *Vindicator* pilots of the Confederation.

## Notable MechWarriors

**Sao-wei Patricia Williams:** Commanding a Shadow Lance within the Dynasty Guards, *Sao-wei* Williams broke her lance through enemy lines to wage a two-month campaign that disrupted supplies inside Blakist-held Franco City in 3070. In the course of destroying thousands of tons of supplies, her lance was slowly whittled down. By the time the operation ended, only she survived and made it back to friendly territory with her 4L model.

**Blind Courage:** One of the first 6L *Vindicators* produced, the machine called "*Blind Courage*" was awarded to the MechWarrior who piloted the original chassis, *Si-ben-bing* Tommy Jerome of the First St. Ives Calvary. During the bitter fighting on New Syrtis, Jerome was acting as rear guard for his lance with his 5L *Vindicator* when he came across a company of Davion battle armor and tanks attempting to flank his unit. With the rest of his lance in no condition for another battle, the *Si-ben-bing* sounded the alarm and charged into the company while the rest of his unit escaped. In the flurry of laser blasts and chaotic blows from both sides, his overheated machine kicked and sliced through the battle armor and vehicles. Although Tommy Jerome ultimately prevailed, he was too injured to maneuver his crippled machine and almost died before being recovered by friendly forces. After laying in a coma for five months, he awoke to find much of his body was replaced with prosthetics and his crippled 5L *Vindicator* rebuilt to 6L specs, complete with a targeting computer salvaged from a vehicle destroyed in the fight.

# VND-3L VINDICATOR

Type: **Vindicator**

Technology Base: Inner Sphere

Tonnage: 45

Battle Value: 1,105

## Equipment

		Mass
Internal Structure:		4.5
Engine:	180	7
Walking MP:	4	
Running MP:	6	
Jumping MP:	4	
Heat Sinks:	15 [30]	5
Gyro:		2
Cockpit:		3
Armor Factor:	144	9

	Internal Structure	Armor Value
Head	3	9
Center Torso	14	18
Center Torso (rear)		9
R/L Torso	11	16
R/L Torso (rear)		6
R/L Arm	7	14
R/L Leg	11	18

## Weapons and Ammo

	Location	Critical	Tonnage
LRM 5	LT	1	2
Ammo (LRM) 24	RT	1	1
CASE	RT	1	.5
ER PPC	RA	3	7
Medium Pulse Laser	H	1	2
Jump Jets	CT	2	1
Jump Jet	LL	1	.5
Jump Jet	RL	1	.5

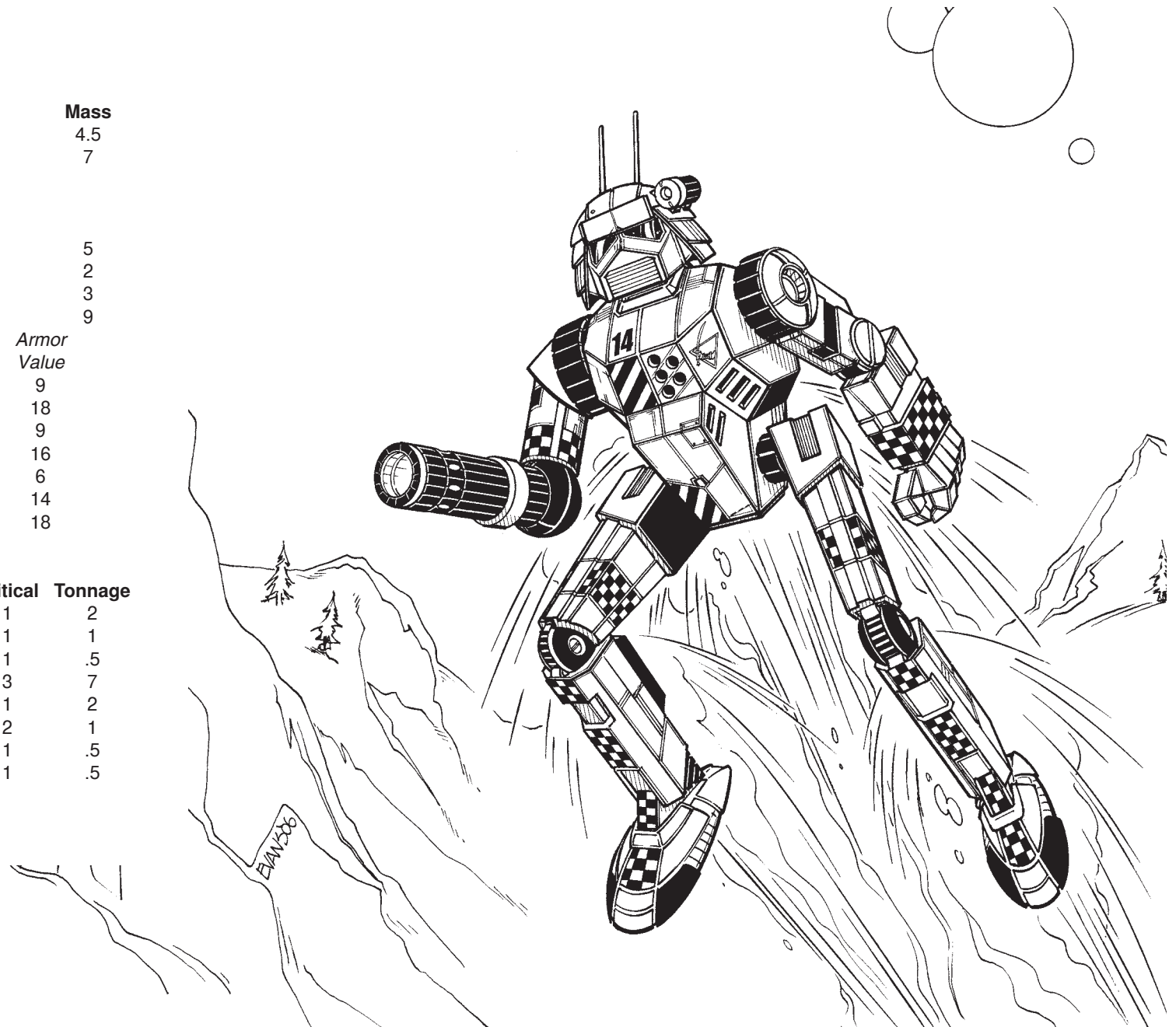

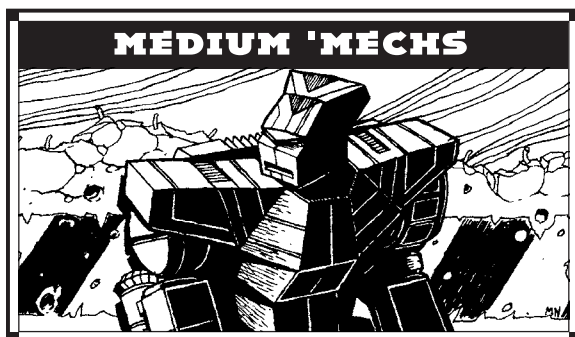

**Mass:** 45 tons

**Chassis:** Alshain Class 580 Endo Steel

**Power Plant:** Hermes 270 XL

**Cruising Speed:** 64 kph

**Maximum Speed:** 97 kph

**Jump Jets:** None

**Jump Capacity:** None

**Armor:** Durallex Special Medium with CASE

**Armament:**

1 Emperor Code Red LB 10-X Autocannon

2 Victory 23R Medium Lasers

1 Shigunga Long Range Missile 10-Rack

**Manufacturer:** Luthien Armor Works

**Primary Factory:** Abiy Adi

**Communications System:** Sipher Security Plus 2

**Targeting and Tracking System:** Eagle Eye 400 XX

## Overview

Originally called the *Tora* by its designers, the BattleMech now more widely known as the *Wolf Trap* was originally conceived as a direct counter to the Lyran *Wolffhound*. Though the *Tora* debuted to some acclaim, the design never really took off among DCMS pilots. LAW executives continued to push for *Tora* sales, billing it as the perfect support unit to their *Dragons* and *Panthers*. Falling behind the FedCom in military hardware, LAW mass produced a large number of the units in a short amount of time.

However, because of the lackluster enthusiasm shown by the DCMS, LAW sold off much of its remaining *Tora* surplus on the Galatean and Fletcher mercenary markets. To separate the 'Mech from its Combine past, LAW officially renamed it the *Wolf Trap* after hear-

ing of the FedCom's use of the moniker. The DCMS ended official procurement of the *Wolf Trap* in 3061.

## Capabilities

When the *Wolf Trap* first debuted in 3051, it garnered a brief reputation as a complementary unit to the DCMS *Dragon* and *Grand Dragon* designs. The longer-ranged LB 10-X autocannon gave the unit some serious reach (at the cost of damaging firepower due to the extensive use of cluster munitions); the LRM-10 rack gave it a nice follow-up punch. However, the lighter armor on the torsos (which housed the extra-light engine and ammunition bays) proved to be an easy weakness to exploit. Smoke Jaguar warriors who came up against the new design quickly learned to target that area and set off the *Wolf Trap's* ammunition bays at long range, incapacitating the Combine 'Mech. Denied a decent chance of survival to gain effective range, the *Wolf Trap* fell out of favor among most DCMS warriors.

## Deployment

When the main LAW complexes on Dieron, Luthien, Quentin, Al Na'ir, and Benjamin were destroyed during the early stages of the Word of Blake's rampage, corporate executives went into panic. Seeing the Combine's primary weapons manufacturer on the brink of collapse, several clandestine deals were struck with other Inner Sphere corporations—possibly selling LAW's soul down the road but providing some short-term relief so the company could regain some shaky footing. One such deal helped fund the completion of a full-scale BattleMech factory on the quiet world of Abiy Adi in the Ningxia Prefecture. Desiring to get something up and into the hands of supply-strapped DCMS units, the LAW manufacturing council quickly authorized the refitting and reintroduction of the *Wolf Trap*. Not exactly the most favored of decisions, it nonetheless has helped bolster most DCMS units due to the hundreds of *Wolf Traps* sitting decommissioned in outlying LAW storehouses.

## Variants

Not an official variant, the WFT-C is a field re-fit in a long-list of "stock" Combine 'Mech designs that are minimally modified to incorporate a C<sup>3</sup> slave. In this case, a

medium laser is dropped to mount the advanced command, communication and coordination gear.

Only one official DCMS variant has been noted coming off the new Abiy Adi line. LAW officials have commented that the new variant is still in a test mode, probably to see if the revamp of the original has a better reception by DCMS pilots. The WFT-2 uses newly acquired technology—a plasma rifle replaces the ammo-starved LB 10-X, and an MML9 replaces the LRM 10 pack. For closer defense against battle armor, a tri-gun arrangement of light machine guns augments the right torso, with an ER medium laser balancing out the design's symmetry. Double heat sinks and a redistribution of armor round out the newer variant.

Most troubling are reports from the Dieron battlefield, where rumors of the LAW complex churning out Blakist variants of Combine designs seem to be rampant. O5P reports have indicated that a Blakist *Wolf Trap* variant has been spotted on occasion with heavier pursuit units. The main difference noted between the original WFT-1 and this new Blakist variant is the downgrading of the LRM system for the possible inclusion of newer electronics. Also of note is the fact that these *Wolf Traps* seem to be sporting more armor, but how such a limited design can carry more protection is more speculation than fact at the moment.

## Notable MechWarriors

**Daitama Muraki:** Officially listed as "KIA" due to a clerical error for years in service to the DCMS, Muraki nonetheless served the Combine well until an overzealous honor duel in 3059 turned into a brutal firefight between the Fourth and Fifth Sun Zhang Cadres. Because of his official status within the DCMS, the Coordinator instead stripped Muraki of rank and sent him to the First Royal BattleMech Regiment, complete with a gutted *Wolf Trap* that Muraki rebuilt from scavenged parts. Captain Muraki was last seen as part of the First Lord's honor guard on Tharkad when the Blakist Jihad ignited.

# WFT-1 WOLF TRAP

Type: **Wolf Trap**

Technology Base: Inner Sphere

Tonnage: 45

Battle Value: 1,071

## Equipment

		Mass
Internal Structure:	Endo Steel	2.5
Engine:	270 XL	7.5
Walking MP:	6	
Running MP:	9	
Jumping MP:	0	
Heat Sinks:	10	0
Gyro:		3
Cockpit:		3
Armor Factor:	120	7.5

	Internal Structure	Armor Value
Head	3	9
Center Torso	14	17
Center Torso (rear)		6
R/L Torso	11	13
R/L Torso (rear)		5
R/L Arm	7	11
R/L Leg	11	15

## Weapons and Ammo

	Location	Critical	Tonnage
LB 10-X AC	RA	6	11
Ammo (LB-X) 20	RT	2	2
CASE	RT	1	.5
2 Medium Lasers	LT	2	2
LRM 10	CT	2	5
Ammo (LRM) 12	RT	1	1

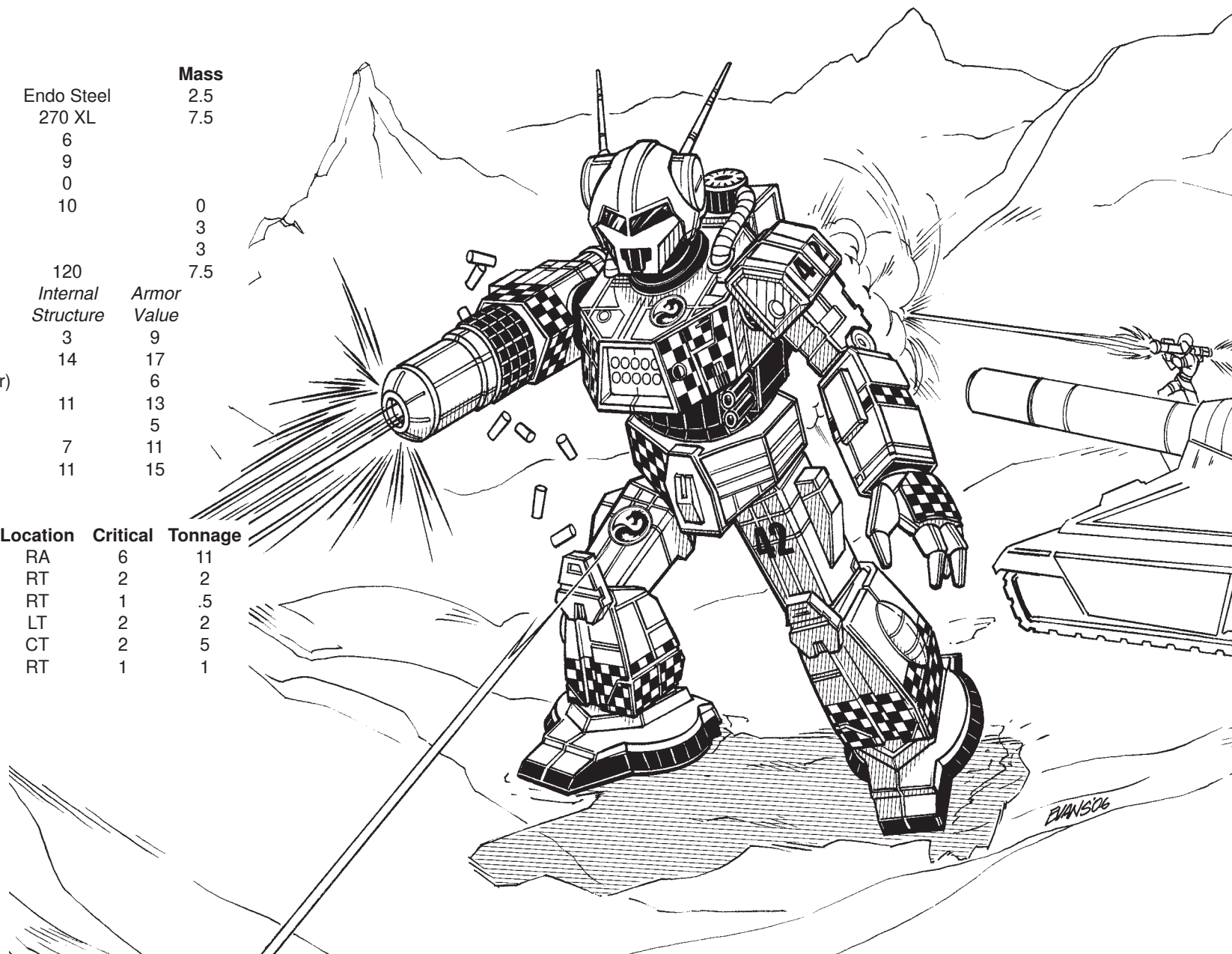

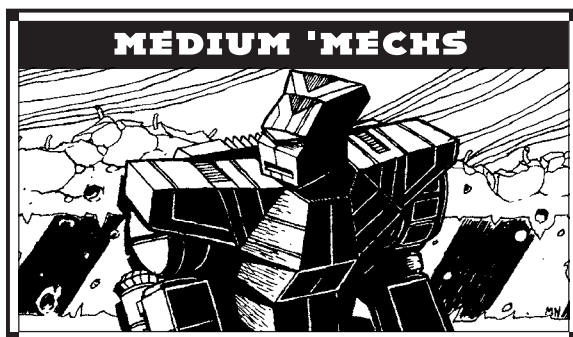

**Mass:** 50 tons

**Chassis:** Corean Model KL77 Endo Steel

**Power Plant:** GM 300 XL

**Cruising Speed:** 64 kph

**Maximum Speed:** 97 kph

**Jump Jets:** None

**Jump Capacity:** None

**Armor:** StarGuard III with CASE

**Armament:**

1 Mydron Excel LB 10-X Autocannon

1 Luxor 3R LRM-10

2 Photech 806c Medium Lasers

**Manufacturer:** Corean Enterprises, Jalastar Aerospace

**Primary Factory:** New Avalon (Corean),  
Panpour (Jalastar)

**Communications System:** Corean Transbanc-J9

**Targeting and Tracking System:** Corean B-Tech  
with Artemis IV

## Overview

Considered a premier medium BattleMech among AFFS forces, the *Centurion* is a solidly built design that has become the primary test bed of new technology developed at the NAIS. It was this technology that saved the *Centurion* from becoming a forgotten footnote among House Davion's line units.

The *Centurion* was initially developed by Corean Enterprises as an operational partner to the more successful *Trebuchet*. When the original Corean plant was destroyed on Ramen II in 2845, replacement parts for the original Luxor-D series autocannon became rare. Though the Luxor-D's mount could accept a different model of autocannon, such modifications were long, time-consuming, and didn't always work. With mount-

ing maintenance problems, the AFFS was on the verge of phasing out the design in the early 3000s.

Corean Enterprises built a new production facility on New Avalon, its location is considered top secret due to the facility's ties with the NAIS. Corean's first order of business was to replace the balky arm mounts with a more flexible arrangement, which helped boost the *Centurion*'s image with technicians everywhere. By offering replacement assemblies at no cost to all AFFS line units, Corean guaranteed the design would remain with the AFFS.

In 3047, Corean allowed Jalastar Aerospace to produce CN9-A models on Panpour under a limited license, which helped lower the model's cost and spread the design. By 3052, *Centurions* were a common sight among many border militias.

Because of Corean's ties with the NAIS, the *Centurion* became a common test platform for new technologies. Triple-strength myomer, rotary autocannons, targeting computers, compact engines, and even the new plasma cannons have all been tested on *Centurions*.

Rumors of the New Avalon Corean plant's destruction have not been confirmed, though no new *Centurions* have entered the beleaguered AFFS forces there. One rumor is that Corean is helping the NAIS develop a new 'Mech platform that continues the Romanesque theme, hence the delay in getting newly built *Centurions* to the front.

Meanwhile, the Panpour facility has doubled its output to reinforce Capellan March forces hit hard by the Confederation.

## Capabilities

The *Centurion* is primarily a mid- to long-ranged fighter. Even though the original design's weapon mounts caused problems for customization, Corean designers have tried to maintain the aesthetic of the original CN9-A. The *Centurion* usually mounts a large-bore autocannon, a long-range missile rack, and some assortment of lasers. Whether any of these weapons are rear-mounted has become a matter of pilot preference; although most prefer to keep their barrels pointed forward.

## Deployment

The *Centurion* is the most common medium BattleMech in the AFFS's arsenal. During the short time the

Suns was merged with the Lyran state, *Centurions* were adapted to some degree with the LAAF.

As each new variant of *Centurion* is unveiled, the AFFS slowly rotates out the older versions to the mercenary market, supplementing the military's budget. On rare occasions a newer variant finds its way into mercenary ranks, usually through outright theft, salvage, or forgetful supply officers.

## Variants

Recently, a new *Centurion* variant (built at the Panpour facility) has taken the field, utilizing the FedSuns' new light ferro-fibrous armor and compact gyro, while mounting a Jalastar Engineering plasma cannon. The bulky torso-mounted jump jets and additional armor has given the *Centurion* a thicker look, which some Confederation and Concordat forces have mistakenly identified as a new BattleMech.

## Notable MechWarriors

**Duke Kai Allard-Liao:** Very few MechWarriors manage to reach legendary status: Natasha Kerensky, Morgan Kell, Yorinaga Kurita. These are names that send shivers of fear down enemy MechWarriors' spines and have thrilled generations through endless holovid adventures that don't come close to capturing their real-life exploits. Arguably at the top of that list is a slender, un-assuming man that began his early military career in constant self-doubt. Two decades of fighting across the Inner Sphere have brought self-assurance and vaulted Kai into the elite few. From single-handedly annihilating the Falcon Guards on Twycross, to his meteoric rise to championship on the gladiator world of Solaris VII, to his furious guerrilla fighting during the Confederation-St. Ives conflict: few have ever demonstrated the superlative skills that come to Kai so naturally. During most of that time he has piloted his father's *Centurion*, the "*Yen-Lo-Wang*": a 'Mech almost as notorious as its pilot.

**Aremas "Pops" Heuaventas:** The only MechWarrior on Corean Enterprises' payroll, Pops has been the company's test pilot for almost fifty years and the only known Davion MechWarrior to pilot every single *Centurion* variant. Pops is currently listed as MIA on New Avalon.

Type: **Centurion**

Technology Base: Inner Sphere

Tonnage: 50

Battle Value: 1,130

## Equipment

		Mass
Internal Structure:	Endo Steel	2.5
Engine:	300 XL	9.5
Walking MP:	6	
Running MP:	9	
Jumping MP:	0	
Heat Sinks:	10	0
Gyro:		3
Cockpit:		3
Armor Factor:	136	8.5

	Internal Structure	Armor Value
Head	3	9
Center Torso	16	18
Center Torso (rear)		7
R/L Torso	12	13
R/L Torso (rear)		6
R/L Arm	8	16
R/L Leg	12	16

## Weapons and Ammo

	Location	Critical	Tonnage
LB 10-X AC	RA	6	11
Ammo (LB-X) 20	RT	2	2
CASE	RT	1	.5
LRM 10	LT	2	5
Ammo (LRM) 24	RT	2	2
Artemis IV FCS	LT	1	1
Medium Laser	CT	1	1
Medium Laser	CT (R)	1	1



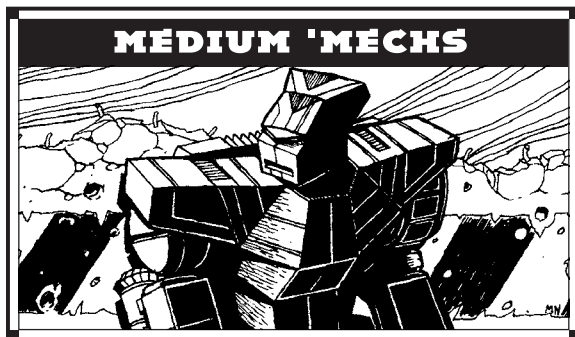

**Mass:** 50 tons

**Chassis:** Dorwinion Standard

**Power Plant:** Magna 250 XL

**Cruising Speed:** 54 kph

**Maximum Speed:** 86 kph

**Jump Jets:** McCloud Special

**Jump Capacity:** 150 meters

**Armor:** StarGuard CIV Ferro-Fibrous with CASE

**Armament:**

1 Mydron Excel LB 10-X Autocannon

1 BlazeFire Sweetshot Extended-Range Large Laser

1 ChisComp 32 Small Laser

**Manufacturers:** Achernar BattleMechs,

Kallon Weapon Industries

**Primary Factories:** New Avalon (Achernar),

Talon (Kallon), destroyed 3069

**Communications System:** Achernar Electronics HICS-11

**Targeting and Tracking System:** Federated Hunter

## Overview

When first put into production almost three centuries ago, no one could have realized that the *Enforcer* would become the Federated Suns' workhorse medium-class 'Mech. Derived from a discarded Star League design that would eventually see life as the *Enfield* in the late 3050s, the *Enforcer* was simple to construct, inexpensive, and amazingly sturdy. It proved its worth to House Davion time and again throughout the centuries.

Still, engineers and *Enforcer* pilots alike knew that the 'Mech could be much more than it was. When the NAIS began to unlock the secrets of lostech, Achernar BattleMechs' design teams devised a new

*Enforcer*, one with all the capabilities modern technology could provide.

## Capabilities

When designing the new *Enforcer*, Achernar's engineers brought in a bevy of veteran *Enforcer* pilots and asked them what they wanted to see most. The greatest concerns by far were speed, ammunition, and armor protection—three qualities that Achernar could easily improve on with the recent advances.

Achernar swapped out the old Nissan 200 engine with an extralight Magna 250, boosting the 'Mech's top speed over thirty percent. The resulting mass savings were used to double the size of the ammunition magazine and to protect it with CASE. Achernar further upgraded the *Enforcer's* weaponry, replacing the standard Federated Autocannon with a class-10 LB-X version and the left arm large laser with a new BlazeFire extended-range model. Finally, Achernar increased the design's jump range to a full 150 meters and mounted StarGuard ferro-fibrous armor, resulting in a more than ten percent boost in armor protection.

## Deployment

Achernar BattleMechs rolled out their new *Enforcer* in late 3050 and began to offer upgrade kits for extant models shortly thereafter. The AFFC immediately contracted to buy the entire *Enforcer* production run for a ten-year period, distributing it to key formations such as the Davion Brigade of Guards, the Lyran Royal Guards and the FedCom Corps, while sending upgrade kits to other prestigious units.

During the Clan Invasion, demand for the *Enforcer* so outstripped Achernar's ability to supply the 'Mech that Prince Hanse Davion ordered Achernar to license the 'Mech to Kallon Weapon Industries on Talon, which retooled several of its less profitable lines to build the *Enforcer*. Even after more than two decades, neither company had slowed production on the 'Mech, until the destruction of the Talon plant in 3069.

## Variants

Due to the production devoted to the 5D, no significant variants of the *Enforcer* appeared until the late 3050s, when models utilizing Clan-derived advances

appeared. The *Enforcer III* debuted after Archon-Prince Victor Steiner-Davion's "Redesign for Davion Pride" order, and it soon spawned additional variants. The first was the ENF-6T, which mates a Poland Gauss rifle and a single Diverse Optics ER medium laser to an advanced targeting computer; the original models were field refits that had an extra half-ton of "dead space," though later factory versions used that mass to increase armor protection while adding a hand actuator to the left arm.

Proposed at the same time, the second variant did not see the light of day until the demand for advanced targeting computer modules led to a widespread shortage; this "G" replaces the "T's" tarcomp with a bevy of lasers. The truly fearsome "H" mounts a massive Mydron class-20 ultra autocannon in the Gauss rifle's place.

## Notable MechWarriors

**Major General Kimberly Severin:** Assigned to the Fox's Den on New Avalon as a lieutenant colonel when the Jihad struck, she and every other able-bodied MechWarrior were put on the line to slow the Blakists' advance on Avalon City. Commanding a provisional battalion, she proved her value numerous times. She now commands the defense of Avalon City, where she and the *Enforcer* that served her so well in the First FedSuns Armored Cavalry and Davion Light Guards are a common sight on the city's streets, lending comfort to soldiers and civilians alike.

**Alexander "Juggles" Jarmuz:** The Capellan Confederation's "Arcade Rangers" are a bag of misfits and discipline problems, and "Juggles" Jarmuz fits right in. Expelled from every school and state-sponsored training facility he ever attended, he nearly found himself permanently imprisoned until he broke out of the work camp he had been sent to, found his way onto the Rangers' base, and stole a BattleMech. Though skilled with electronics, he had no formal 'Mech training and made a mess of the base until the Rangers subdued him and his *Enforcer*. His punishment: a billet in the Rangers training cadre and the assignment to fix every broken and malfunctioning electronic system in the regiment.



# ENF-5D ENFORCER

MEDIUM 'MECHS

57

Type: **Enforcer**

Technology Base: Inner Sphere

Tonnage: 50

Battle Value: 1,308

## Equipment

Internal Structure:

Engine: 250 XL

Walking MP: 5

Running MP: 8

Jumping MP: 5

Heat Sinks: 12

Gyro: 2

Cockpit: 3

Armor Factor: 161

Internal Structure	Armor Value
--------------------	-------------

Head	3	9
------	---	---

Center Torso	16	23
--------------	----	----

Center Torso (rear)		7
---------------------	--	---

R/L Torso	12	19
-----------	----	----

R/L Torso (rear)		5
------------------	--	---

R/L Arm	8	16
---------	---	----

R/L Leg	12	21
---------	----	----

## Weapons

### And Ammo

LB 10-X AC

Ammo (LB-X) 20

ER Large Laser

CASE

Small Laser

Jump Jets

Jump Jets

Jump Jet

Location	Critical	Tonnage
RA	6	11
RT	2	2
LA	2	5
RT	1	.5
LT	1	.5
RT	2	1
LT	2	1
CT	1	.5

Mass

5

6.5

2

3

3

9

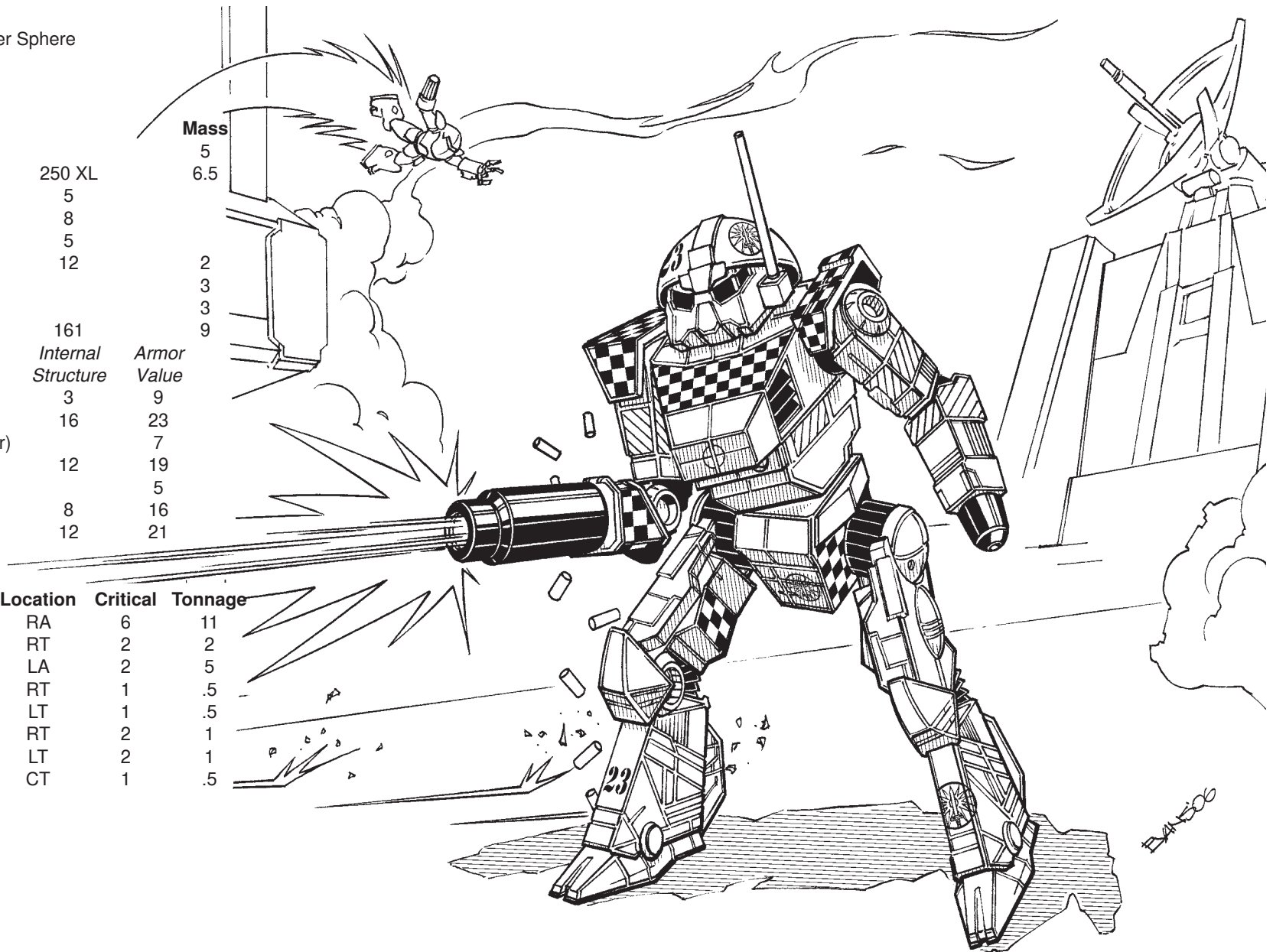

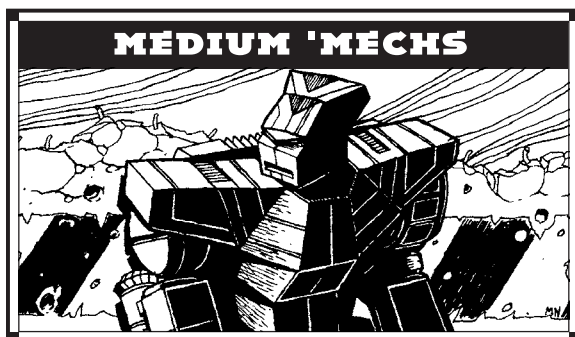

**Mass:** 50 tons

**Chassis:** Crucis Type V

**Power Plant:** Magna 200

**Cruising Speed:** 43 kph

**Maximum Speed:** 64 kph

**Jump Jets:** None

**Jump Capacity:** None

**Armor:** Durallex Tensile-4 with CASE

**Armament:**

1 Kali Yama Big Bore Autocannon/20

2 Hellion-V Medium Lasers

1 Sunglow Prism-Optic Small Pulse Laser

**Manufacturer:** Kali Yama Weapons Industries

**Primary Factory:** Kalidasa

**Communications System:** Omicron 4002

Networking Channel

**Targeting and Tracking System:** TRSS Eagle Eye

## Overview

The Free Worlds League made a concerted effort to upgrade its BattleMech forces as new technology was slowly proliferating during the 3040s. Making sparing use of the recovered technology available at the time, Kali Yama started production of 5M *Hunchbacks* in 3046.

## Capabilities

Charged with updating the *Hunchback* while keeping the BattleMech's soul intact, Kali Yama engineers minimally upgraded the machine. The primary change was the installation of double heat sinks, which turned the *Hunchback* into a cool running machine resistant to engine damage and baths of Inferno gel.

Besides the limited range of its weaponry, the *Hunchback's* biggest weakness was ammunition explosions. To address this, the engineering team protected the Kali Yama's ammunition bay with CASE. The team also fixated on offhand MechWarrior comments about the under-utilized head-mounted small laser and decided to upgrade the laser to a pulse model. This change prevented other possible upgrades, however. To compensate for the laser's added weight, the engineers removed a ton of autocannon ammunition, leaving a mere five shots for the feared main gun. They justified the reduction to angry MechWarriors with the improved laser and a reduction in the chance of battle damage detonating the ammunition. Despite this questionable change, the 5M upgrade met all FWLM specifications in the contract and was quickly put into production.

## Deployment

The 5M *Hunchback* enjoyed widespread use in the FWLM until Operation Guerrero, when several key advances failed due to ammunition exhaustion. FedCom units quickly learned to send out highly mobile units to harass the 5Ms in an attempt to exhaust the *Hunchbacks'* ammunition before main AFFC forces were engaged. MechWarriors began to unofficially modify their BattleMechs to carry extra ammunition (creating what was later called the HBK-5N), leading Kalidasa to standardize (and improve) the changes in the 6N.

## Variants

The ad hoc field modification dubbed HBK-5N retains the double heat sinks but loses the pulse laser and CASE for more ammunition. The more formalized ammunition-increasing variant, the HBK-6N, removes three heat sinks for three additional tons of ammunition. Kalidasa has also been refitting one of the more popular "Swayback" variants with new technology. This 5P *Hunchback* mounts half-a-dozen ER medium lasers backed up with pulse lasers, more heat sinks, and a state-of-the-art electronics suite, including ECM and a C<sup>3</sup> slave module. These are being delivered to FWLM units siding with the Word of Blake.

Norse-Storm opened a *Hunchback* refit line shortly after the massive LB 20-X autocannon became commercially available, resulting in the 5S. In less than a

year, the popular refit line was converted into a full assembly line. Endo-steel and a light fusion engine allow the medium lasers to be upgraded to pulse lasers. Jump jets and CASE make this variant a capable urban fighter.

Since the introduction of the 5S, Norse-Storm has been developing two more variants. The 5SS "Swayback" keeps the light engine, endo-steel, and jump jets of its cousin, but mounts a pair of Artemis-equipped MML-9 launchers in place of the single massive cannon. Three extended-range medium lasers provide secondary support, and a once-experimental heavy duty gyro increases the 5SS's durability. The second new variant, the now-canceled 5SG, was to include stealth armor and a Gauss rifle.

## Notable MechWarriors

**Hauptmann John "Big Foot" Bailey:** The former XO of Norse-Storm's security force, Hauptmann Bailey and two of his lances went rogue. They commandeered a company DropShip shortly after Capellan courts deemed the disastrous Shengli *Spector* contract binding. Leading from his 5S *Hunchback*, his force landed on Victoria months later and quickly pushed aside the defenses. They stole several hundred tons of stealth armor, then retreated off world, razing several of the newly reopened production lines as they departed, which stalled Shengli's production by eight months. In retaliation Shengli has halted all further stealth armor shipments to Loxley.

Norse-Storm vocally denies any connection with the rogue force and has posted a sizeable reward on the heads of the deserters, but with the condition of turning them in alive and unharmed. However, in a separate move after the raid, Norse-Storm detained all of its Shengli's aides who were overseeing the stealth armor installation and has yet to stop production of the new "Stealth *Spectors*," even though they lack armor. The story wears thinner when the timing is considered: Bailey went rogue only after every effort by Norse-Storm to mitigate the effects the *Spector* contract, including legal appeals and corporate espionage misadventures, went sour.

# HBK-5M HUNCHBACK

MEDIUM 'MECHS

59

Type: **Hunchback**

Technology Base: Inner Sphere

Tonnage: 50

Battle Value: 1,054

## Equipment

Internal Structure:

Engine: 200

Walking MP: 4

Running MP: 6

Jumping MP: 0

Heat Sinks: 13 [26]

Gyro: 2

Cockpit: 3

Armor Factor: 160

Internal Structure	Armor Value
--------------------	-------------

Head	3	9
------	---	---

Center Torso	16	26
--------------	----	----

Center Torso (rear)		5
---------------------	--	---

R/L Torso	12	20
-----------	----	----

R/L Torso (rear)		4
------------------	--	---

R/L Arm	8	16
---------	---	----

R/L Leg	12	20
---------	----	----

## Weapons and Ammo

	Location	Critical	Tonnage
--	----------	----------	---------

AC/20	RT	10	14
-------	----	----	----

Ammo (AC) 5	LT	1	1
-------------	----	---	---

CASE	LT	1	.5
------	----	---	----

Medium Laser	RA	1	1
--------------	----	---	---

Medium Laser	LA	1	1
--------------	----	---	---

Small Pulse Laser	H	1	1
-------------------	---	---	---

## Mass

5

8.5

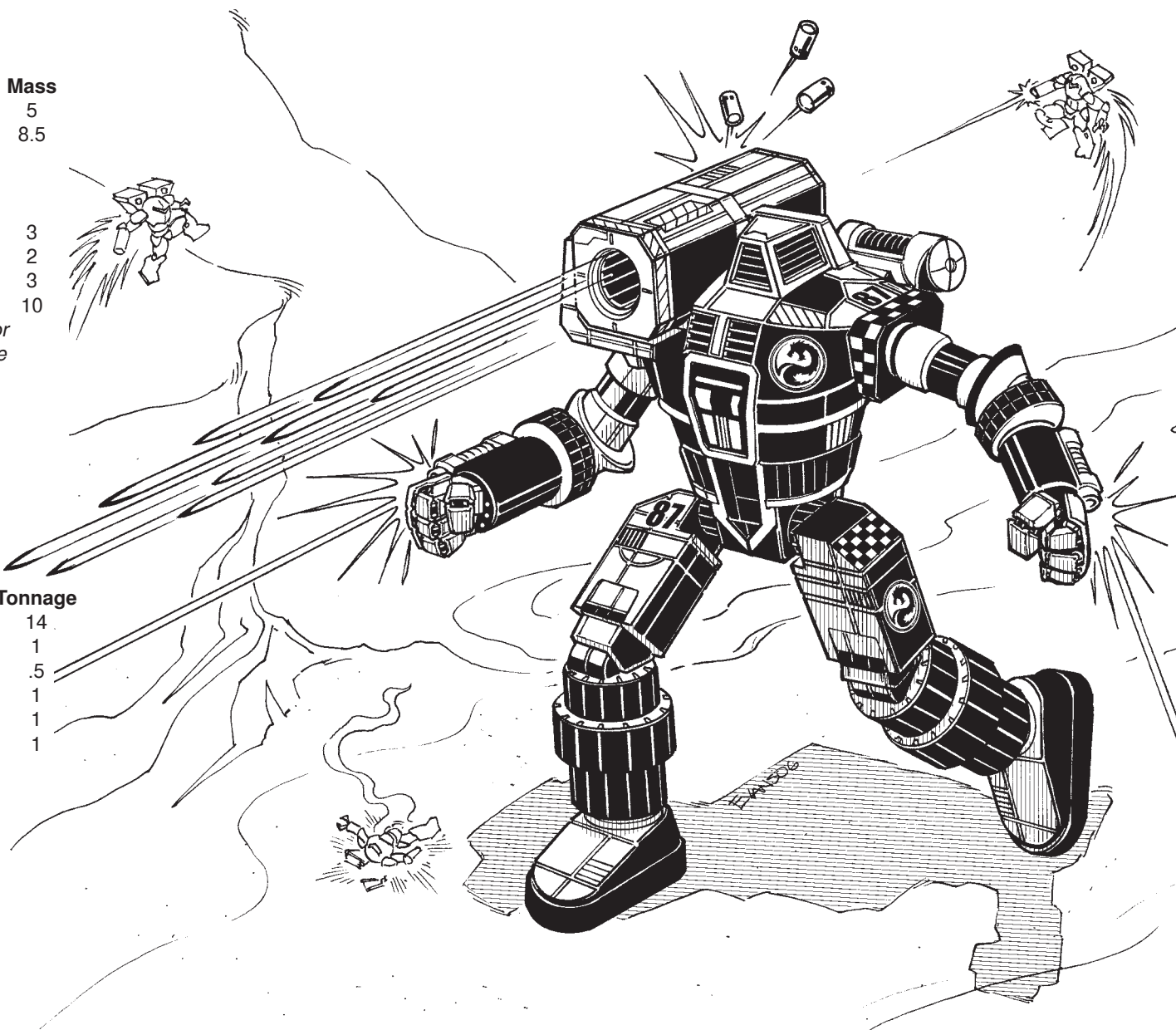

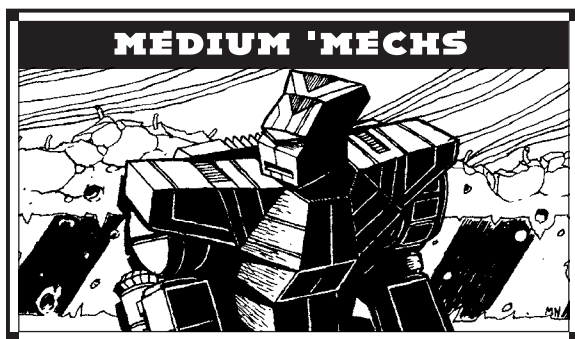

**Mass:** 50 tons

**Chassis:** Corean-II Deluxe Endo Steel

**Power Plant:** Magna 250 XL

**Cruising Speed:** 54 kph

**Maximum Speed:** 86 kph

**Jump Jets:** Rawlings 50

**Jump Capacity:** 150 meters

**Armor:** Starshield with CASE

**Armament:**

2 Zeus LRM-15 Launchers

3 Magna Mark II Medium Lasers

1 Octagon Missile-Magnet Narc Beacon

**Manufacturer:** Corean Enterprises, Kali Yama

Weapons Industries, Irian BattleMechs Unlimited

**Primary Factory:** Stewart (Corean),

Kalidasa (Kali Yama), Irian (Irian)

**Communications System:** Corean TransBand-J9

**Targeting and Tracking System:** Corean B-Tech

## Overview

The *Trebuchet* was one of a handful of BattleMech designs produced during the final years of the Star League, the period between Terra's liberation by Kerensky and the departure of the SLDF that heralded the Succession Wars. As a result, the original design—the TBT-3C model—was lost fairly quickly to the sands of time, replaced by the cheaper and more easily produced 5N series. Renowned for its good mobility and respectable hitting power both as a fire-support unit and a raider, the *Trebuchet* found itself widely dispersed throughout the Succession Wars.

## Capabilities

Designed to serve as part of a well-balanced lance, the *Trebuchet* (in most variants) relies on an effective combination of good mobility and a weapons load that is equal parts missile support and close-in lasers. To maximize its capabilities, Corean Enterprises initially gave the TBT-3C a 300 XL engine, endo-steel construction, double heat sinks, and CASE. Armed with two Artemis-equipped LRM-15s and four medium lasers, the 3C was a formidable opponent. The rapid decline caused by the Succession Wars, however, forced the interstellar conglomerate to “dumb down” the 'Mech significantly before the end of the First Succession War, resulting in the more common TBT-5 series (particularly the 5N). The technological renaissance of the 3030s made it possible to upgrade the *Trebuchet* at last, which no less than three manufacturers did in the years just prior to the Clan invasion.

## Deployment

Although they were intended for Terran Hegemony and SLDF forces before the collapse and their first runs were widely deployed, the *Trebuchet* has since become an almost exclusive staple of the Free Worlds League (and, today, its Word of Blake “allies”). A large part of this, of course, is the fact that all three of this 'Mech's surviving manufacturing sites happened to fall within Free Worlds space.

## Variants

The TBT-7M retains the firepower of the 5N model, but because it uses endo-steel construction and an XL engine, Corean designers were able to outfit it with jump jets, CASE, double heat sinks and a Narc Missile Beacon that did not exist on the 5N. By way of comparison, the Succession Wars variants were cruder by nature. The TBT-5J, which debuted in 2850 from the Corean plants on Stewart, used the 5N as a baseline and removed its left arm LRMs in favor of a 150-meter jump capability and two more standard heat sinks. The 5S, most common in its day after the 5N, instead swapped its LRM-15s for Thunderstroke SRM-6s and eight extra sinks.

With the advent of the Combine's MRM weapons system, the DCMS upgraded some of its own supply of field refitted 7M *Trebuchets*. This 7K version upgrades the right arm medium lasers to pulse weaponry and adds a C<sup>3</sup> Slave to the left torso. The LRM-15s in this model are also traded in for a pair of MRM-20s with three tons of ammunition between them.

The most recent introduction to the *Trebuchet* family is the 8B model, which emerged from the production lines on Kalidasa in 3071. Apparently designed to blend the best features of several variants into one chassis, the 8B uses an XL engine the same size as those found on the extinct 3C, as well as employing the jump jets found in the 5M. This model trades in its LRM-15s for two MML-5 racks in the left arm and right torso, while four arm-mounted ER medium lasers provide excellent reach and hitting power to supplement them. Thirteen double-strength freezers attempt to manage this heat load, but an 8B *Trebuchet* can easily find itself overwhelmed if its pilot is not careful.

## Notable MechWarriors

**Lieutenant (Junior Grade) Charles Tecumseh Rodrigo Sorin:** Piloting his trusty “*Weed Wacker*” TBT-5J *Trebuchet*, Sorin is most noted among the Camacho's Caballeros mercenary unit for his record-breaking sixty-four rejections by members of both sexes. Stylizing himself as an old-school ‘cowboy’ of Terra's late nineteenth century, he refuses to admit defeat despite the variety of colorful advice passed to him by lancemates and bar patrons. However, not even Sorin is brave enough to try and woo Cassandra “Abtakha” Suthorn, despite his lancemates in the Fourth Battalion egging him on; he knows a Castle Brian when he sees one and has admitted defeat outright. Sorin's *Trebuchet* is unremarkable in the field except for its noticeable swagger—his lancemates swear the *Weed Wacker* runs just like its bow-legged pilot.

# TBT-7M TREBUCHET

Type: **Trebuchet**

Technology Base: Inner Sphere

Tonnage: 50

Battle Value: 1,348

## Equipment

Internal Structure:	Endo Steel	2.5
Engine:	250 XL	6.5
Walking MP:	5	
Running MP:	8	
Jumping MP:	5	
Heat Sinks:	10 [20]	0
Gyro:		3
Cockpit:		3
Armor Factor:	120	7.5

	Internal Structure	Armor Value
Head	3	9
Center Torso	16	22
Center Torso (rear)		7
R/L Torso	12	11
R/L Torso (rear)		5
R/L Arm	8	10
R/L Leg	12	15

## Weapons and Ammo

	Location	Critical	Tonnage
LRM 15	RT	3	7
Ammo (LRM) 8	RT	1	1
CASE	RT	1	.5
LRM 15	LA	3	7
Ammo (LRM) 8	LT	1	1
CASE	LT	1	.5
Narc Missile Beacon	LT	2	3
Ammo (Narc) 12	LT	2	2
2 Medium Lasers	RA	2	2
Medium Laser	LA	1	1
Jump Jet	CT	1	.5
Jump Jets	LT	2	1
Jump Jets	RT	2	1

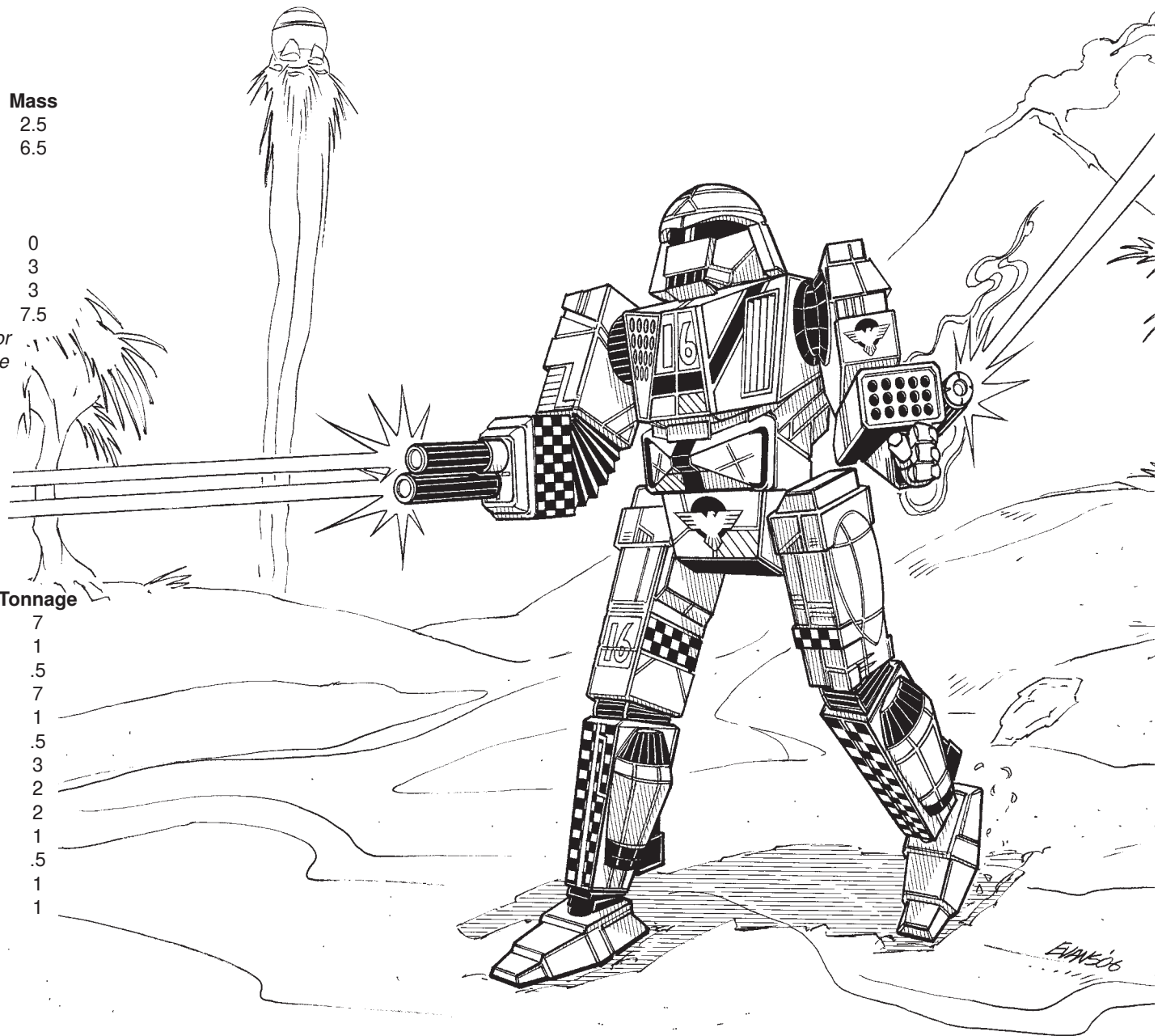

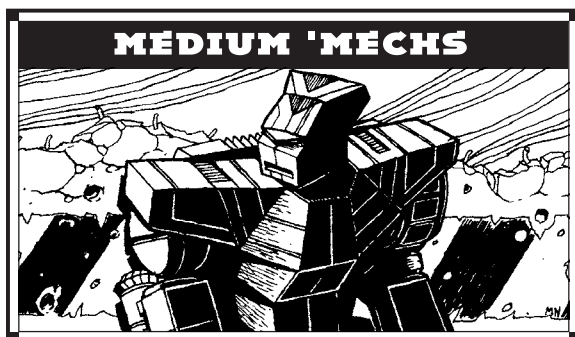

**Mass:** 55 tons

**Chassis:** Dorwinion Standard 55TES

**Power Plant:** Core Tek 275

**Cruising Speed:** 54 kph

**Maximum Speed:** 86 kph

**Jump Jets:** Swingline X-1000

**Jump Capacity:** 150 meters

**Armor:** StarGuard CIV Ferro-Fibrous with CASE

**Armament:**

2 Federated 10-Shot LRM Missile Systems

2 Chris Comp 39 Medium Lasers

2 Federated SuperStreak Dual-SRM Launchers

**Manufacturer:** Achernar BattleMechs

**Primary Factory:** New Avalon

**Communications System:** Achernar Electronics HID-21

**Targeting and Tracking System:** Federated Hunter Mk II

## Overview

The *Dervish* has had a long history of success on the battlefield, but it has long been viewed as a “poor man’s *Archer*”—a view, however, that is not shared by those who actually pilot or fight alongside the design. Though frequently used as a fire-support ‘Mech, it has enough short-ranged firepower to keep it from being a liability. Originally designed for the SLDF and once widely sold around the Inner Sphere, war left Achernar with just one operating plant. Most *Dervishes* went to replenish the ranks of the Federated Suns or Federated Commonwealth. Even House Davion appeared to lose interest in the design, though with the return of advanced technology, Achernar hoped to add some

pizzazz to the *Dervish*. The refits of 3047 were helpful in boosting sales, but they have not reached the level that Achernar predicted. Indeed, all that saved Achernar from re-tooling its *Dervish* lines was the increased demand for ‘Mechs in the run up to, and during, the FedCom civil war. However, Achernar remains optimistic that the latest variant will turn things around.

## Capabilities

The *Dervish* relies on mobility and long-range firepower to accomplish its mission. A pair of LRM-10s provides twice as much fire support as a Valkyrie, and five Swingline Jump Jets allow the ‘Mech to overcome obstacles and maneuver nimbly in close combat. With twin SRM-2 Streaks and medium lasers, the *Dervish* is able to provide a decent punch to any unit that has endured its long-range barrages to close with it. The addition of double heat sinks allows the *Dervish* to fire all its weapons without overheating. Some heat management is needed if the pilot uses the jump jets with all the weaponry in play, but Achernar hasn’t heard any complaints. Eight tons of ferro-fibrous armor provide a decent level of protection, though the ‘Mech is slightly under-armored when compared to most ‘Mechs of its weight. The dual CASE system allows the *Dervish* to keep fighting even after an ammunition explosion.

## Deployment

*Dervishes* can be found throughout the Inner Sphere in almost any armed force. However many of the older models have been moved to militia or reserve units. The upgraded *Dervishes* are mostly found in the AFFS, as the Lyrans are more partial to the *Griffin*. The lack of an XL engine has kept the price down, and smaller mercenary units have found the ‘Mech to be durable and easy to maintain.

## Variants

While the 7D kept the *Dervish* from disappearing, sales didn’t take off and Achernar was forced to resort to heavy lobbying to keep New Avalon buying. The 8D was the dramatic upgrade most had expected. Using an XL engine to free up mass, Achernar upgraded the

launchers to Artemis-equipped LRM-15s while dropping the SRMs in favor of another pair of medium lasers and upgrading all four to the extended-range variety. Two more tons of armor were added to boost the *Dervish*’s protection.

Not waiting to be forced into a new variant, Achernar jumped at the chance to use the new multi-missile launcher and designed the 9D around them. Mounting four MML-5s with five tons of ammunition, Achernar kept the extended-range medium lasers and added a targeting computer to enhance laser targeting. They also added another heat sink and thickened the armor to eleven and a half tons to help the 8D weather fire.

## Notable MechWarriors

**Ukla Mauck:** A fierce Azami warrior in the Second Akrab Legion, Ukla pilots a nearly 200-year-old *Dervish* that one of his ancestors captured. He has since replaced his missile launchers with MRMs and added triple-strength myomers, making him a terror at close range. On Lyons, an *Axman* thought little of a *Dervish* at close range and tried to make quick work of him. After chopping at the *Axman*’s armor with his missiles for several minutes, Ukla closed and finished the Davion warrior off toe-to-toe. Ukla was offered a *No-Dachi* but turned it down in favor of the ‘Mech he feels defines his heritage in more than one way.

**Matthew “Rawhide” Francis:** Known for his tenacity and rugged pursuit of opponents, Rawhide is a favorite of the Caph Rowdies, a mercenary company that frequents both sides of the Capellan March. He is probably known best for his reported chasing down of a fleeing *Shadow Hawk* across 350 kilometers of the Salazaar desert on Bromhead.

# DV-7D DERVISH

MEDIUM 'MECHS

63

Type: **Dervish**

Technology Base: Inner Sphere

Tonnage: 55

Battle Value: 1,412

## Equipment

Internal Structure:	Endo Steel	3
Engine:	275	15.5
Walking MP:	5	
Running MP:	8	
Jumping MP:	5	
Heat Sinks:	10 [20]	0
Gyro:		3
Cockpit:		3
Armor Factor:	143	8

	Internal Structure	Armor Value
Head	3	9
Center Torso	18	21
Center Torso (rear)		5
R/L Torso	13	19
R/L Torso (rear)		5
R/L Arm	9	13
R/L Leg	13	17

## Weapons and Ammo

	Location	Critical	Tonnage
LRM 10	RT	2	5
Ammo (LRM) 12	RT	1	1
CASE	RT	1	.5
LRM 10	LT	2	5
Ammo (LRM) 12	LT	1	1
CASE	LT	1	.5
Medium Laser	RA	1	1
Medium Laser	LA	1	1
Streak SRM 2	RA	1	1.5
Ammo (Streak) 50	RT	1	1
Streak SRM 2	LA	1	1.5
Ammo (Streak) 50	LT	1	1
Jump Jet	CT	1	.5
Jump Jets	RL	2	1
Jump Jets	LL	2	1

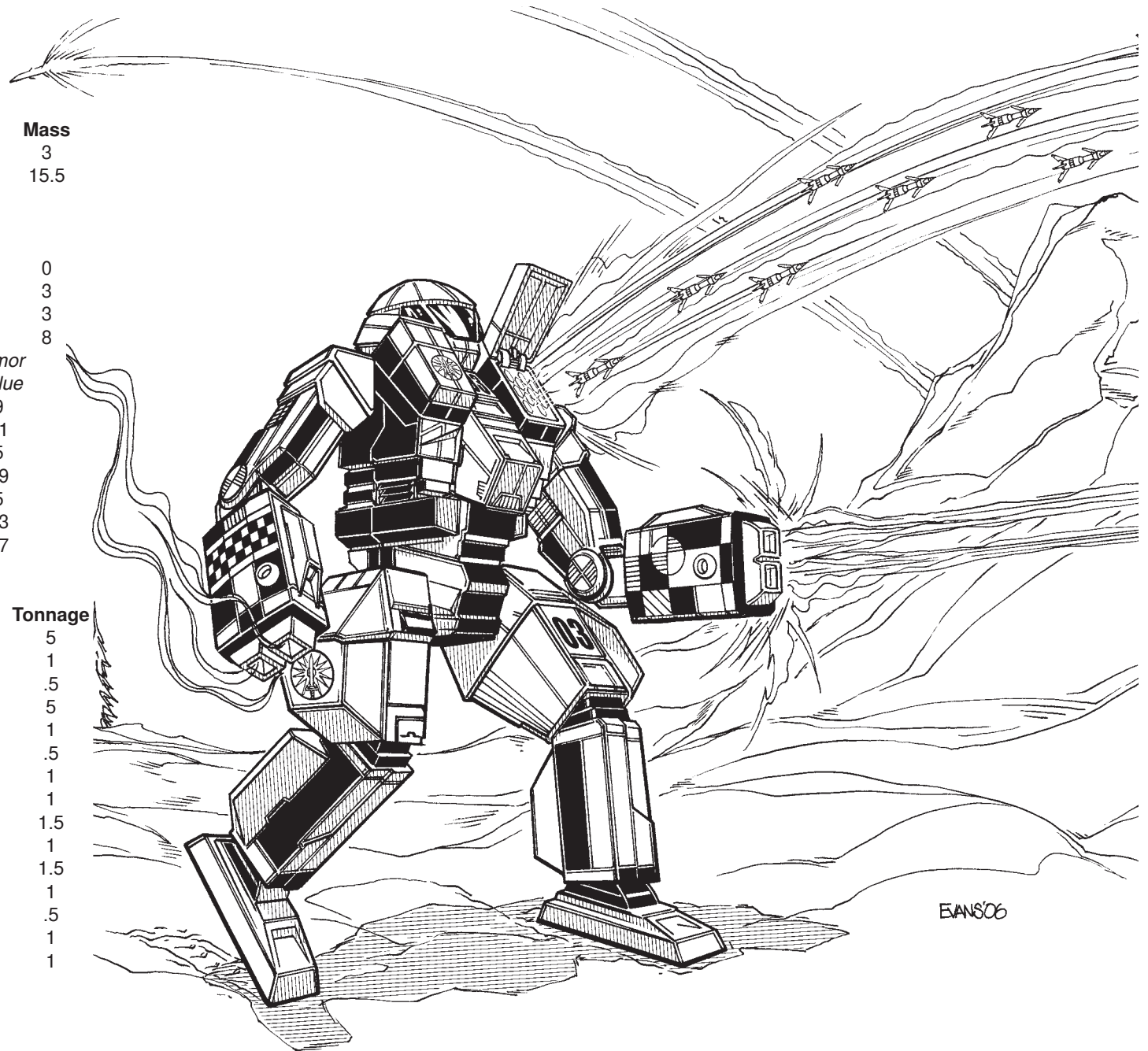

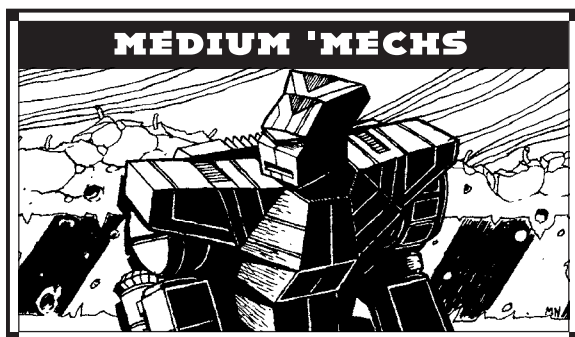

**Mass:** 55 tons

**Chassis:** Star League HO-01a

**Power Plant:** DAV 220

**Cruising Speed:** 43 kph

**Maximum Speed:** 64 kph

**Jump Jets:** None

**Jump Capacity:** None

**Armor:** DuraShield 12-b.1

**Armament:**

1 Mydron Excel LB 10-X Autocannon

1 Conan/5 LRM-5

**Manufacturer:** Martinson Armaments

**Primary Factory:** Terra (destroyed 2767)

**Communications System:** MultiGab 2000

**Targeting and Tracking System:** Dalban HiRez II

## Overview

Conceived of as a support 'Mech, Martinson Armaments produced the *Hoplite* for deployment with the infantry divisions of the newly created Star League Defense Force. Entering service in 2578, the 'Mech saw extensive action in the opening battles of the Reunification War. After a failed attempt to create a mainline combat version, Martinson upgraded the electronics to create the HOP-4C. This version continued in service into the twenty-seventh century, when it was relegated to Terran Hegemony Militia commands.

Originally thought to have been lost in the chaos of the Amaris Coup and Succession Wars, the design reappeared in the ranks of Wolf's Dragoons. Following the start of the Clan Invasion the mercenaries refitted their *Hoplites* with recovered Star League technology.

## Capabilities

Intended to operate closely with infantry, the *Hoplite's* uninspired top speed is little hindrance. However, attempts to deploy the 'Mech in other roles met with varied success. Reliable and with low maintenance requirements, the *Hoplite's* over-dependence on ammunition keeps it firmly anchored to its supply lines.

Wolf's Dragoons have field-modified their *Hoplites*, replacing the old autocannon with a Mydron Excel LB 10-X, a weapon with improved accuracy and range. Lighter than the Luxor HV autocannon, the upgrade allowed magazine capacity to be doubled.

## Deployment

The *Hoplite* first saw action against Taurian troops on Ridgebrook. Surprisingly capable of absorbing considerable punishment, the *Hoplites* allowed the infantry of Second Division to withstand determined Concordat counterattacks. With frontal assaults failing to break the SLDF line, the Taurians were forced to fall back on the defensive. Having demonstrated its effectiveness, the *Hoplite* became a common sight in 'Mech battalions assigned to work with the SLDF's infantry formations.

As the Reunification War dragged on, the *Hoplite* became outmoded when the SLDF's tactical doctrine evolved in the face of the realities of Taurian campaign. With increasingly advanced designs coming out of the Terran Hegemony's factories, the *Hoplite* was redeployed to serve alongside designs such as the *Mackie* and *Banshee* in Hegemony militia units. These commands would suffer the heaviest casualties, with most being killed to the last warrior, when the Rim World Republic seized control of the Terran Hegemony in late 2766 to early 2767.

Today the *Hoplite* now only appears in the ranks of Wolf's Dragoons. Drawing equipment from the oldest Clan Wolf Brian Caches, the Dragoons were unaware that the lost 'Mech would draw so much attention. Cut off from the Homeworlds after 3020, the Dragoons no longer have access to the resources to replace lost *Hoplites*. By the end of the Fourth Succession War only a handful remained in the mercenary's ranks, and these were later consigned to the Home Guard.

## Variants

The original HOP-4A is essentially identical to the HOP-4C. The older Dalban Sniper targeting system was upgraded to the Dalban HiRez during the Reunification War to counter the increasingly sophisticated Taurian ECM systems.

Wolf's Dragoons fielded a single example of the HOP-4B during the Fourth Succession War. An unsuccessful attempt by Martinson Armaments to produce a main battle 'Mech, the 4B carries a Magna Hellstar PPC in place of the autocannon and upgrades the missile launcher to a Mitchell Systems LRM-15 rack and two tons of ammunition.

The Dragoons have also upgraded the *Hoplite* with salvaged ClanTech taken on Luthien. Designated the *Hoplite C*, this version mounts ten tons of Clan ferro-fibrous armor and ten double heat sinks. Primary armament consists of an Ultra AC/10 with three tons of ammunition and an LRM-15 with two tons of ammunition. Secondary weaponry consists of three torso-mounted medium lasers, two pulse and one extended-range.

## Notable MechWarriors

**Kevin Tolek:** Amongst the orphans inducted into Wolf's Dragoons after the Fourth Succession War, Tolek joined Gamma Regiment just in time for the Clan invasion. Distinguishing himself by scoring three kills against the Nova Cats on Luthien, Tolek went on to build a formidable reputation for himself.

When Wayne Waco (serving as the Word of Blake's cat's-paw) launched his surprise attack on Outreach, Gamma returned to Outreach and secured the world while other commands launched the ill-fated attack on Mars. Soon Tolek was locked in combat with Blakist troops amidst the rubble of Harlech. Salvaging a Home Guard *Hoplite* after his *Imp* was destroyed, he remained on Outreach with the other Gamma survivors to continue a guerrilla campaign while Alpha fled with the Dragoons' dependents.

Extracted from Outreach by a Clan Wolf (in-Exile) force in 3068, Tolek was reunited with other Dragoon survivors on Arc-Royal.



# HOP-4D HOPLITE

Type: **Hoplite**

Technology Base: Inner Sphere

Tonnage: 55

Battle Value: 1,022

## Equipment

Internal Structure:

Engine: 220

Walking MP: 4

Running MP: 6

Jumping MP: 0

Heat Sinks: 16

Gyro: 3

Cockpit: 3

Armor Factor: 184

*Internal Structure* 11.5  
*Armor Value*

Head 3 9

Center Torso 18 26

Center Torso (rear) 9 9

R/L Torso 13 18

R/L Torso (rear) 9 8

R/L Arm 9 18

R/L Leg 13 26

## Weapons and Ammo

LB 10-X AC

Location Critical Tonnage

RA 6 11

Ammo (LB-X) 20 RT 2 2

LRM 5 LA 1 2

Ammo (LRM) 24 CT 1 1

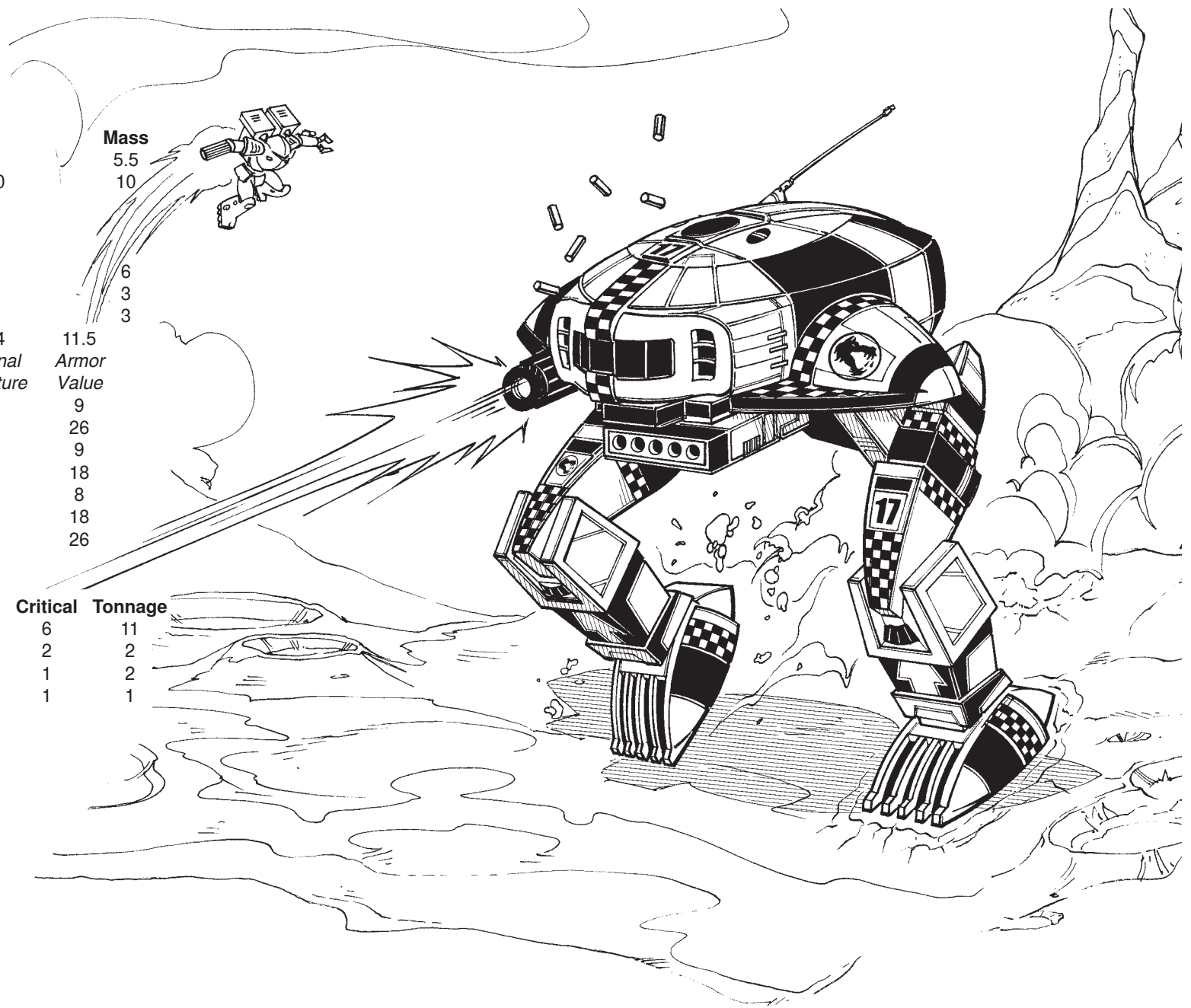

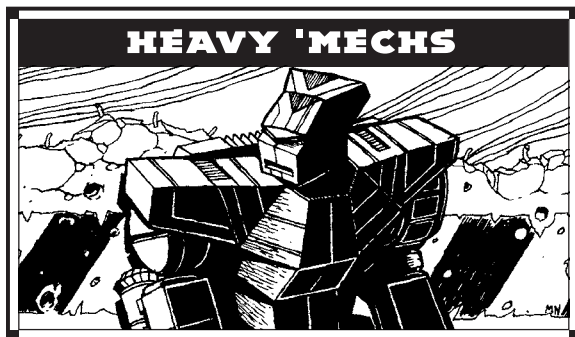

**Mass:** 60 tons

**Chassis:** Nykvarn Type 58-66SH

**Power Plant:** Hermes 360 XL

**Cruising Speed:** 64 kph

**Maximum Speed:** 97 kph

**Jump Jets:** None

**Jump Capacity:** None

**Armor:** Starshield with CASE

**Armament:**

1 Telos DecaCluster LRM Missile System

1 Lord's Light 2 Extended-Range  
Particle Projector Cannon

3 Victory 23R Medium Lasers

**Manufacturer:** Luthien Armor Works

**Primary Factory:** Nykvarn

**Communications System:** Sipher CommSys 3

**Targeting and Tracking System:** Eagle Eye SY10-10

## Overview

A fully upgraded replacement for the venerable *Dragon* series using newly re-discovered Star League technology, the *Grand Dragon* entered initial production in 3040. Over the next fifteen years, Luthien Armor Works replaced all their *Dragon* assembly lines with the *Grand Dragon* series, using the DRG-5N as a bridging design between the two.

Produced at several LAW facilities—including Luthien, Dieron, Saffel, and Yorii—*Grand Dragon* manufacturing almost ceased between 3068 and 3070 due to the Word of Blake's devastating attacks at the industrial heart of the Dieron District as well as the complete destruction of LAW's Luthien complex. Thanks to the quick-thinking executives of the

Combine's foremost arms manufacturer, the shortage appears to be short-lived.

LAW sold off several current design specifications, mainly joint projects with other manufacturers, such as the co-built *Blackjack* Omni, for a short-term influx of capital. Approaching several Clan-ravaged worlds in the Pesht District, LAW then invested that capital in building several small factories. Within two years, at least three facilities were up and running—the modified plant on Abiy Adi, a rebuilt facility on Savinsville, and an entirely new facility on Nykvarn.

Thanks to an innovative engineering team, the Nykvarn plant was awarded the initial *Grand Dragon* production. The team there had analyzed the older Alshain type 56-60H chassis of the 'Mech and discovered a process to enhance the hip and torso structure. They presented their findings to the LAW R&D team, showing how an alternate assembly method could fuse the two sections together faster and provide a greater torque threshold, giving the *Grand Dragon* nearly 300 degrees of rotation, as opposed to the limited 250 degrees.

Impressed with their initiative, LAW immediately granted the Nykvarn facility the *Grand Dragon* production license and their blessing to incorporate their findings into the new chassis.

## Capabilities

The *Grand Dragon* was embraced wholeheartedly by the DCMS and became a common design in many of the Kuritan line units. The effective mix of heat efficiency, moderate speed, longer-ranged weapons and little ammo reliance has made the *Grand Dragon* extremely versatile for many battlefield roles.

## Deployment

Though the *Grand Dragon* was out of production for nearly two years, it is still a favored BattleMech of the DCMS. The Nykvarn-produced models have been shipping almost nonstop from the system. Nearly every DCMS line unit still operational has at least a company of *Dragons* or *Grand Dragons* in service. With parts still easy to come by, these units are guaranteed to remain a large part of the Combine's military arm for quite some time.

## Variants

Shortly after the development of C<sup>3</sup> technology, LAW designed a C<sup>3</sup> slave variant after DCMS commanders demanded it. Pulling out one of the rear-mounted lasers and swapping it with a C<sup>3</sup> slave system is an easy upgrade, and many of the DCMS's C<sup>3</sup>-equipped companies sport several of the DRG-C variant.

Less common is the DRG-7K platform, which mounts the more controversial MRM system. Though cheap, the constant system bugs and upgrades guarantee field problems for most MechWarriors. The ones still in service are usually piloted by veteran MechWarriors who have learned how to adapt to the system's quirks and use it to deadly effect.

LAW recently deployed a C<sup>3</sup> Master version of the *Grand Dragon* to mollify the more hidebound commanders who insisted on having *Dragon* and *Grand Dragon*-pure companies in their units. By removing an additional laser, replacing the standard LRM rack with a more versatile MML-5 launcher, and swapping out the Lord's Light ER PPC with an Echo-Static snub-nosed version, LAW engineers managed to squeeze a C<sup>3</sup> master into the torso. This newer variant—the DRG-9KC—also incorporates the Combine's new light ferro-fibrous armor technology, allowing the 'Mech to mount an additional one-and-a-half tons of protective plate.

## Notable MechWarrior

**Busosenshi Emory Wilk:** An original member of Sorenson's Sabres, Emory Wilk piloted one of the original *Grand Dragon* designs (a conversion from the older DRG-1G Dragons) after his *Rifleman* was destroyed by a traitor to the unit in 3034. Though repeatedly offered a newer version of the *Grand Dragon* after 3048, Wilk preferred to constantly update his own machine. Emory Wilk was essential in much of LAW's secret weapons testing through the 3050s until his untimely death in 3057, when an experimental Gauss system exploded; the massive feedback caused permanent brain damage and he died in his sleep a month later.

Emory Wilk was a close friend to *Tai-i* Daniel Sorenson, who named his second son after him in 3058.

# DRG-5K GRAND DRAGON

Type: **Grand Dragon**

Technology Base: Inner Sphere

Tonnage: 60

Battle Value: 1,356

**Equipment**

Internal Structure:

Engine: 360 XL

Walking MP: 6

Running MP: 9

Jumping MP: 0

Heat Sinks: 13 [26]

Gyro: 4

Cockpit: 3

Armor Factor: 160

**Mass**

6

16.5

*Internal Structure*    *Armor Value*

Head 3 9

Center Torso 20 27

Center Torso (rear) 12

R/L Torso 14 16

R/L Torso (rear) 8

R/L Arm 10 14

R/L Leg 14 18

**Weapons and Ammo**

LRM 10    CT    2    5

Ammo (LRM) 24    LT    2    2

CASE    LT    1    .5

ER PPC    RA    3    7

Medium Laser    LA    1    1

Medium Laser    LT (R)    1    1

Medium Laser    RT (R)    1    1

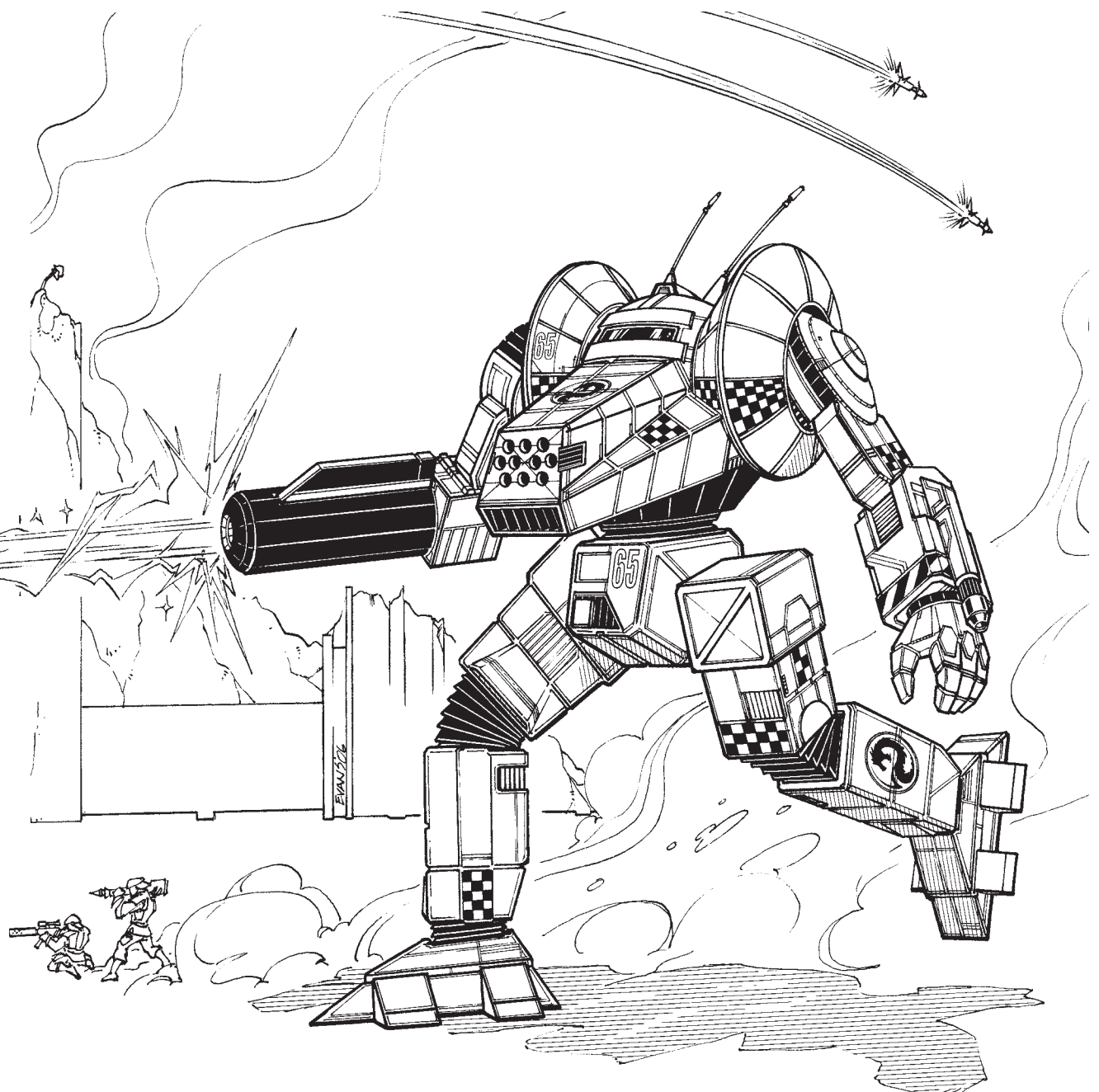

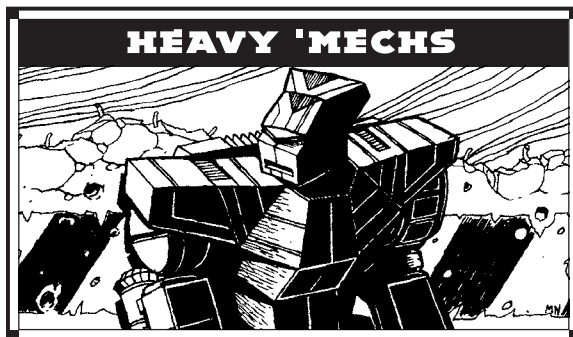

**Mass:** 60 tons

**Chassis:** Technicon Type E

**Power Plant:** Magna 300

**Cruising Speed:** 54 kph

**Maximum Speed:** 86 kph

**Jump Jets:** Chilton 460

**Jump Capacity:** 150

**Armor:** Kallon FWL Special Ferro-Fibrous with CASE

**Armament:**

1 Delta Dart LRM-10 Missile Rack

1 Hovertec SRM-4 Detachable Missile Rack

4 Omicron 400 Medium Lasers

**Manufacturer:** Technicon Manufacturing

**Primary Factory:** Savannah

**Communications System:** Garret T12E

**Targeting and Tracking System:** Dynatec 2180

## Overview

Intended as a replacement for the *Rifleman* when it was introduced in 2779, the original QKD-4G *Quickdraw* never supplanted the older 'Mech. Over the course of the Succession Wars, this solid heavy earned the respect of MechWarriors and a place in every major military. However, it suffered from heat dissipation problems that prevented its lasers being used effectively for protracted periods or used in conjunction with frequent jumps.

## Capabilities

Technicon's QKD-5M solved the heat problems plaguing the QKD-4G by replacing the single heat sinks with double-strength versions more than able to

handle the temperatures produced by the lasers and jump jets. The Marik design also replaced the Riese-475 armor with modern Kallon FWL special ferro-fibrous, giving the new design improved defense while also installing CASE.

All of these additional features meant something had to go. The Hovertec four-tube short-range missile launcher and its one ton of ammunition were dropped from the 4G *Quickdraw*. In its place is mounted a Hovertec SRM-4 one-shot missile rack. These one-shot packs are usually attached to attack VTOLs, hovercraft, or other vehicles whose mission profile calls for one-pass attacks. The use of such a pack on a BattleMech is unusual though not unheard of. The one-shot pack severely limits the *Quickdraw's* short-range punch, but the benefits of the systems upgrades made possible by the elimination of the SRM ammunition more than make up for the loss.

The only structural issue, which was intended as a useful mobility enhancement, is the *Quickdraw's* ankle actuators. These actuators were designed to give the BattleMech a sure-footed stance and mobility in a variety of terrains, but their flexibility makes them vulnerable to direct attack. In melee situations, another 'Mech can immobilize or even destroy the ankle assembly with a well-placed kick.

One little known feature of the design is its specially modified arm actuators, which enable the *Quickdraw* to fire its arm-mounted weapons to the rear, providing a nasty surprise for would-be attackers.

## Deployment

*Quickdraws* are reliable workhorses found in the military of every successor state. The modern 5M design has been steadily replacing the 4G in frontline units throughout the Inner Sphere. However, older 4Gs are a common sight among Periphery nations and second-tier mercenary commands. Due to its reliance on missiles, the *Quickdraw* is less common among pirates who prefer the independence of energy-only BattleMechs.

## Variants

Luthien Armor Works' QKD-5K replaces the QKD-4G's LRM launchers with two medium lasers. Seven-

teen double heat sinks handle the excessive heat of this design. A common modification is to swap the Hovertec one-shot missile rack to the back and bring the rear-facing medium lasers to the front. Though reorienting the lasers and recalibrating the targeting systems to accommodate the arrangement is a time-consuming operation, it is technically straightforward and can be undertaken by any competent tech support facility in the field.

The QKD-C is a common variant of the QKD-5K, swapping out 1 rear-facing medium laser for a C<sup>3</sup> slave.

A final LAW variant introduced in the 3060s was more radical. Utilizing an endo-steel chassis to free up more space, the QKD-8K mounts four ER medium lasers and an MRM-30 with two tons of ammunition.

## Notable MechWarriors

**Kevin Jessup:** Hauptmann Jessup was scheduled to retire after decades of competent but unremarkable service commanding First Company of Second Battalion in the Twenty-Sixth Lyran Guards when Khan Natasha Kerensky and Alpha Galaxy of Clan Wolf landed on Tamar in November of 3051. Duke Kelswa, convinced his personal guard could defend Tamar, refused to give the Guards support and barred them outside his fortified position. When Kommandant Silvia Lamont, CO of Second Battalion, fell, the other officers turned to Jessup. With his unit trapped on open ground beneath the walls of Tamar City, Jessup's simple command was "Stand and deliver." Blunting the Clan Wolf thrust, Second Battalion held position, allowing the bulk of the battered Guards to withdraw in good order before yielding the field to superior forces. Three weeks later, when Clan Wolf's Beta Galaxy attacked the Twenty-sixth on Kobe, Lieutenant General Jinders Green-Davion cited Jessup's Second Battalion and their "preternatural cool under fire" as a major factor in the unit's survival. Wounded on Thurn, Jessup was forced to retire against his will. He, in his family's unmodified QKD-4G, had made seven confirmed OmniMech kills on three worlds in the space of a month. Though it is believed the aged warrior has taken a teaching position in a smaller academy, Jessup's whereabouts are unknown.

# QKD-5M QUICKDRAW

Type: **Quickdraw**

Technology Base: Inner Sphere

Tonnage: 60

Battle Value: 1,237

## Equipment

Internal Structure:

Engine: 300

Walking MP: 5

Running MP: 8

Jumping MP: 5

Heat Sinks: 13 [26]

Gyro: 3

Cockpit: 3

Armor Factor: 143

Internal Structure	Armor Value
--------------------	-------------

Head	3	9
------	---	---

Center Torso	20	18
--------------	----	----

Center Torso (rear)		8
---------------------	--	---

R/L Torso	14	17
-----------	----	----

R/L Torso (rear)		8
------------------	--	---

R/L Arm	10	13
---------	----	----

R/L Leg	14	16
---------	----	----

## Mass

6

19

5

8

5

3

3

3

8

## Weapons and Ammo

	Location	Critical	Tonnage
--	----------	----------	---------

LRM 10	LT	2	5
--------	----	---	---

Ammo (LRM) 12	LT	1	1
---------------	----	---	---

CASE	LT	1	.5
------	----	---	----

SRM 4 (OS)	CT	1	2.5
------------	----	---	-----

Medium Laser	LA	1	1
--------------	----	---	---

Medium Laser	RA	1	1
--------------	----	---	---

Medium Laser	LT (R)	1	1
--------------	--------	---	---

Medium Laser	RT (R)	1	1
--------------	--------	---	---

Jump Jet	CT	1	1
----------	----	---	---

Jump Jets	LT	2	2
-----------	----	---	---

Jump Jets	RT	2	2
-----------	----	---	---

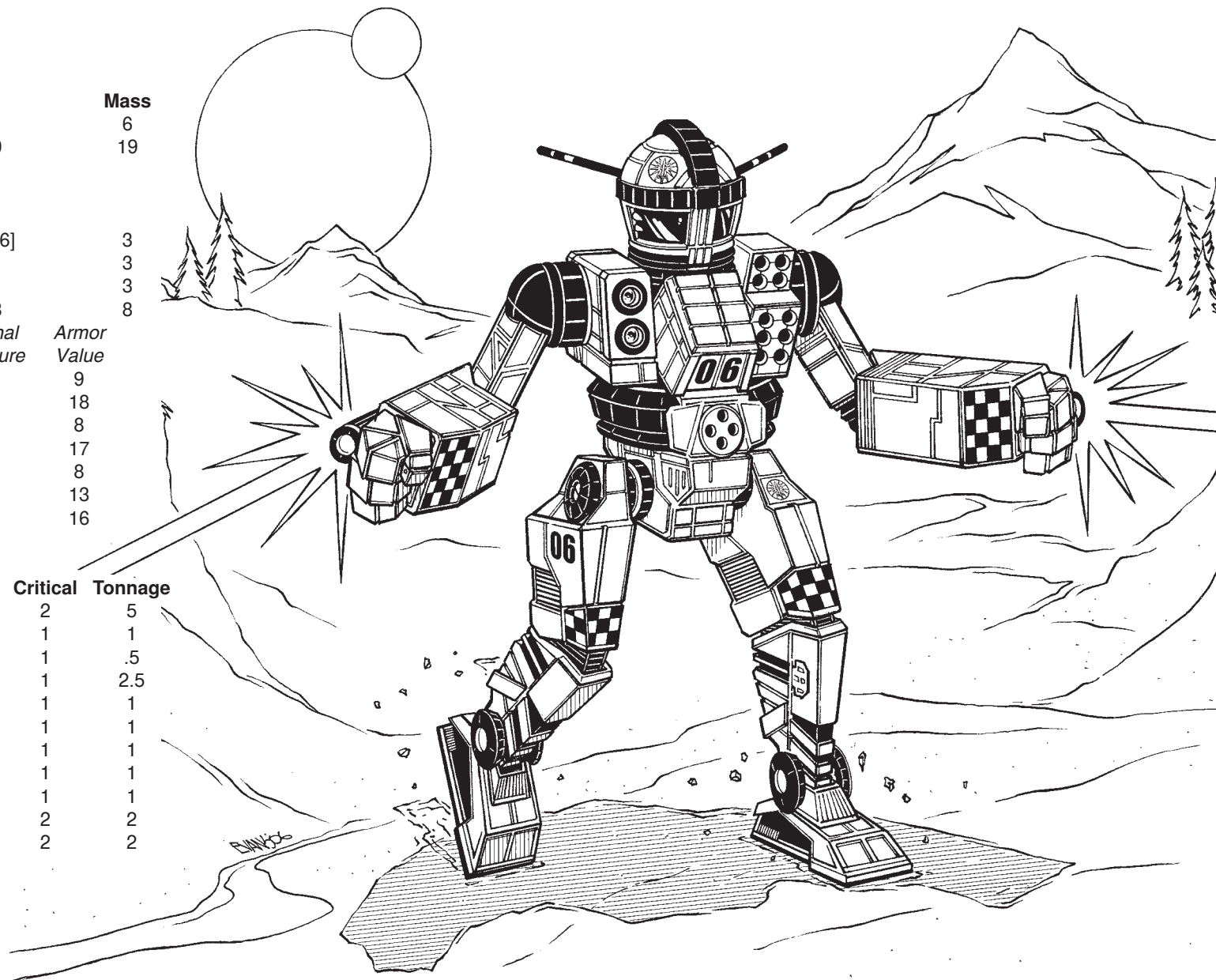

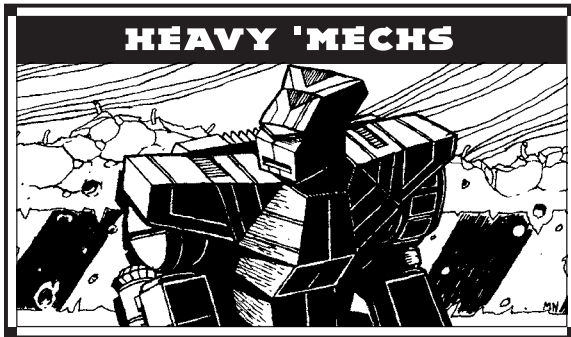

**Mass:** 65 tons

**Chassis:** Dorwinion AXM Standard

**Power Plant:** Magna 260 XL

**Cruising Speed:** 43 kph

**Maximum Speed:** 64 kph

**Jump Jets:** HildCo Model 12

**Jump Capacity:** 120 meters

**Armor:** Kallon Unity Weave Ferro-Fibrous with CASE

**Armament:**

1 Luxor Devastator-20 Autocannon

3 Intek Medium Lasers

1 Sutel Precision Line Large Pulse Laser

**Manufacturer:** Johnston Industries, Defiance Industries

**Primary Factory:** New Syrtis (Johnston),  
Furillo (Defiance)

**Communications System:** Johnston Wide Band

**Targeting and Tracking System:** Rander Pinpoint-HY

## Overview

A symbol of the FedCom alliance, the *Axman's* design and deployment, according to some, was the product of "Steiner inspiration and Davion perspiration." Built along the same lines as the Lyran *Hatchetman* (a 'Mech as much noted for being the first new design to emerge since the dawning years of the Succession Wars as it was for its full-head ejection system and integrated melee weapon), the *Axman* was bigger, tougher, more devastating, and just as mobile. Though primarily produced on New Syrtis by Johnston Industries, the *Axman's* composition of components from all over the FedCom and its allied territories at the time

were an effort to further cement the sense of unity espoused by the founders of the alliance.

Sadly, these very features nearly put this 'Mech on the endangered species list when the alliance fell apart in 3057.

## Capabilities

The original model *Axman*—the AXM-1N—is a devastating close-in fighter, with its five-ton hatchet backed up by the crippling firepower of an assault-grade autocannon. A cluster of lasers (one large pulse and three standard mediums) backs up this offensive punch to assure that any units evading the *Axman's* swing may still feel its sting. Using some of the latest in recovered technologies, the *Axman* proved an effective fighter, with excellent maneuverability and armor protection for its size and armament.

## Deployment

The FedCom allies deliberately deployed *Axman* BattleMechs among their forces in both halves of the realm. The addition of a Lyran-based line on Furillo (specializing in the 2N variant) in the late 3050s seemed one more step toward cementing this 'Mech's place in the FedCom military infrastructure when the Lyran Alliance suddenly seceded from the Commonwealth in 3057. With numerous component contracts spread across the fragmenting nation, engineers in both factories were forced to work off surplus stores while seeking new suppliers, factors that have slowed down the production of this unit in both states ever since.

## Variants

The AXM-2N variant, made famous by then-Major Adam Steiner of the AFFC, first emerged in limited numbers in the late 3040s, sporting twin shoulder-mounted LRM-15s in place of the AC/20. This alternate weapon load improved the *Axman's* role as a support unit, and it became a favored model when dealing with Clan raiders throughout and following the invasion.

The AXM-3S emerged from Defiance Industries' Furillo lines soon after the Lyran secession, and it has become known as a distinctly Lyran machine. This

variant uses a light engine to improve its survivability in combat and swaps out the 1N's AC/20 for an LB version with four tons of ammo. In addition, the 3S model drops the Sutel large pulse laser in favor of a Guardian ECM system while upgrading the medium lasers to the extended-range models. These changes heighten the *Axman's* utility as an anti-vehicle and anti-battle armor unit.

The newest *Axman* variant to hit the field, however, was the FedSuns model AXM-4D that debuted in 3071, all but replacing the 1N production line. This model mounts twin Light AC/5s in each side torso (with twenty shots apiece), backed up by a pair of medium lasers all slaved to a targeting computer. This 'Mech lacks the jump capability of the other *Axman* models but has superior accuracy and heat management capabilities (despite a cost-cutting decision to employ standard sinks) and relies much less on foreign suppliers.

## Notable MechWarriors

**General of the Armies Adam Steiner:** Long before he became General of the Armies, Adam Steiner—descendant of Simon Borge Steiner, who refused the throne in favor of his more capable sister, Tatyana—was a strategic instructor at the Nagelring Academy when the Clan invasion began. Driven to investigate these invaders and liberate his homeworld of Somerset, Steiner formed an ad hoc force he dubbed the First Somerset Strikers and led them into numerous engagements against Clan Jade Falcon from the cockpit of his AXM-2N *Axman*. Though his hollow victory on Somerset (where his *Axman*—then piloted by his brother Andrew—was reported lost) formed the basis for a poorly reviewed holovid miniseries, the campaign itself first demonstrated the tactical and strategic acumen that earned Steiner his current position as the virtual ruler of the LAAF and the embattled Lyran Alliance.

# AXM-1N AXMAN

Type: **Axman**

Technology Base: Inner Sphere

Tonnage: 65

Battle Value: 1,369

## Equipment

Internal Structure:

Engine:

Walking MP:

Running MP:

Jumping MP:

Heat Sinks:

Gyro:

Cockpit:

Armor Factor:

		Mass
		6.5
260 XL		7
4		
6		
4		
10 [20]		0
		3
		3
179		10

	Internal Structure	Armor Value
--	--------------------	-------------

Head	3	9
Center Torso	21	28
Center Torso (rear)		6
R/L Torso	15	21
R/L Torso (rear)		6
R/L Arm	10	17
R/L Leg	15	24

## Weapons and Ammo

AC/20  
Ammo (AC) 10  
CASE  
3 Medium Lasers  
Large Pulse Laser  
Hatchet  
Jump Jets  
Jump Jets

Location	Critical	Tonnage
RT/CT	8/2	14
LT	2	2
LT	1	.5
RA	3	3
LA	2	7
RA	5	5
RL	2	2
LL	2	2

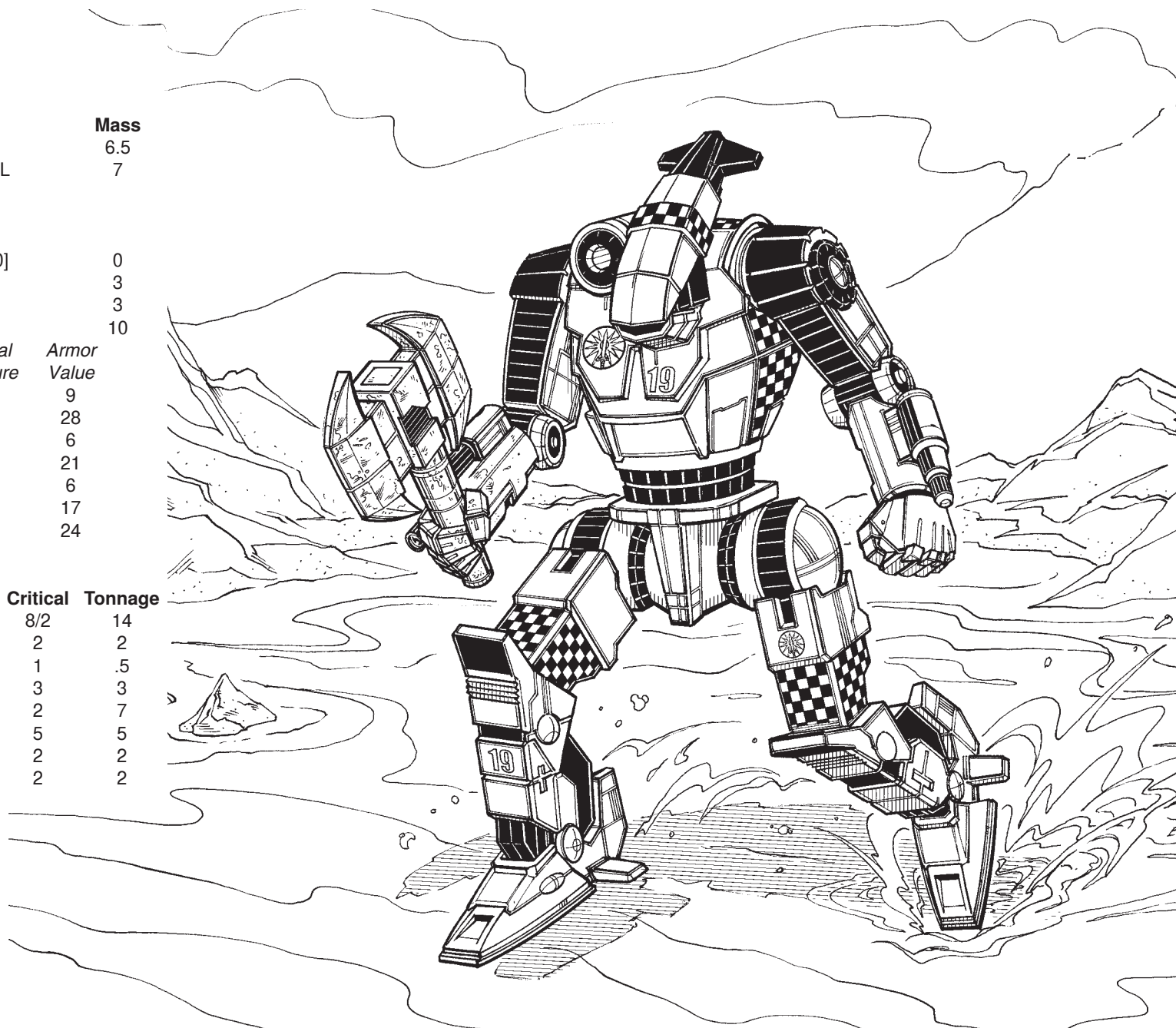

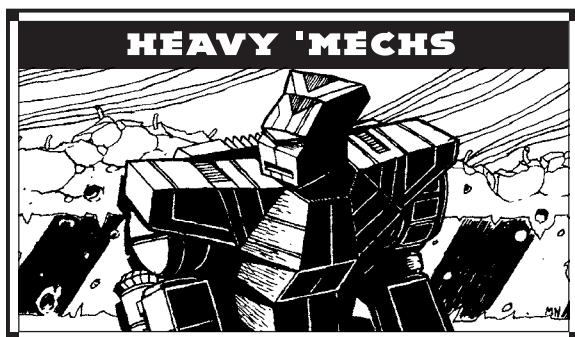

**Mass:** 65 tons  
**Chassis:** Hollis Mark II  
**Power Plant:** Magna 260  
**Cruising Speed:** 43 kph  
**Maximum Speed:** 64 kph  
**Jump Jets:** Anderson Propulsion 21  
**Jump Capacity:** 120 meters  
**Armor:** Durallex Heavy  
**Armament:**  
1 Luxor Mobile Battery Arrow IV Missile System  
4 Martell Medium Lasers  
**Manufacturer:** Yori Mech Works  
**Primary Factory:** Al Na'ir  
**Communications System:** O/P COM-211  
**Targeting and Tracking System:** O/P 1078

## Overview

Though produced only in limited numbers at the dawn of the Star League, the *Catapult* has remained a venerable design that has proven its worth time and again over the centuries.

## Capabilities

While the original *Catapults* based their fire support on missile racks, the CPLT-C3 was the first 'Mech to mount the newly re-discovered Arrow IV Missile Artillery System. However, the variant's deficiencies quickly brought to light the design's short development and testing cycle; the Capellan Confederation rushed the entire process. While the design still retained some of the faults of the C1—notably the un-

dependable Anderson Propulsion 21 jump jets—the most bemoaned aspect of the C3 was its pitiful five shots for the artillery system.

Despite these shortcomings, the Confederation made excellent use of tandem C3 *Catapults* and *Ravens*, bringing mobile 'Mech artillery to the forefront of modern-day combat. The far superior, tailor-designed *O-Bakemono* might not exist if not for the C3 paving the way for 'Mech-mounted artillery.

## Deployment

The Capellan Confederation and Draconis Combine field the majority of extent *Catapults*, though many Periphery realms still deploy a few centuries-old chassis.

## Variants

Though never produced in the quantities of better-known designs, the *Catapult* has still managed to appear in a number of variants.

In an effort to correct the many problems of the CPLT-C3, the CPLT-C5 appeared during the St. Ives Conflict. Double heat sinks and endo-steel allow this variant to upgrade all four medium lasers to extended-range versions while quadrupling the ammo for the Arrow IV and significantly increasing armor coverage.

The CPLT-H2 is a strange bird. Apparently based off of the CPLT-K2, it trades one PPC and the machine guns for eight twenty-tube rocket launchers. Thirteen double heat sinks help alleviate the heat.

A significant departure from the CPLT-C3, the CPLT-K5 has more in common with the original C1 *Catapult*. Incorporating an XL engine and endo-steel, the Yori Mech Works version mounts twin MRM-30s, twin pulse medium lasers, twelve double heat sinks, and a C<sup>3</sup> slave.

Two new variants have appeared since the start of the Jihad. The first is the CPLT-K4, which is actually based on a prototype CPLT-K3 that saw very limited use following the War of 3039. Utilizing recently re-discovered technologies at the time, the K3 dispensed with the jump jets of the K2 to mount twin extended-range PPCs and twenty double heat sinks. The K4 is

the logical successor to that relatively unknown variant. Mounting twin heavy PPCs, two ER medium lasers and a C<sup>3</sup> slave along with seventeen double heat sinks, the K4 is a powerhouse weapons platform for its weight. To accomplish this, designers had to downgrade the venerable Magna 260 to a Magna 195. Mounting light ferro-fibrous armor allowed the maximization of armor on the K4.

The newest variant seen on the battlefield is the C6, a field-refit of the C5 (so straightforward it still mounts the CASE of the C5 even if the equipment is not needed). First appearing during the desperate fighting against the Capellan March by House Liao, the C6 trades the Arrow IV System and two ER medium lasers for twin plasma rifles—each with three tons of ammo—and mounts fifteen double heat sinks.

## Notable MechWarriors

**Lieutenant Geoff Tillson:** A member of the command company of the newly formed Devil's Brigade mercenary unit, Geoff has not made a name for himself so much as the new variant he pilots has made a name for him. One of only a handful of CPLT-K4 variants known to currently exist, the fact that he recently upgraded from an older *Catapult* to this variant has rumors flying. The most notable involves Chandrasekhar "Uncle Chandy" Kurita and his connections to the Brigade. Considering Uncle Chandy's wealth and his skein of contacts across the Inner Sphere—not to mention his propensity for eccentric behavior—it is a rumor easily believed. While Major Keller and the Brigade are reticent to discuss such a connection, the impetuous Tillson is more than happy to foster the rumors, while never actually confirming anything. While such notoriety is unlikely to help him on the battlefield, his star has risen in mercenary circles.



# CPLT-C3 CATAPULT

Type: **Catapult**

Technology Base: Inner Sphere

Tonnage: 65

Battle Value: NA

## Equipment

		Mass
Internal Structure:		6.5
Engine:	260	13.5
Walking MP:	4	
Running MP:	6	
Jumping MP:	4	
Heat Sinks:	15	5
Gyro:		3
Cockpit:		3
Armor Factor:	160	10

	Internal Structure	Armor Value
Head	3	9
Center Torso	21	24
Center Torso (rear)		11
R/L Torso	15	19
R/L Torso (rear)		8
R/L Arm	10	13
R/L Leg	15	18

## Weapons and Ammo

	Location	Critical	Tonnage
Arrow IV System	RT/RA	6/9	15
Ammo (Arrow IV) 5	RT	1	1
Medium Laser	LT	1	1
Medium Laser	RT	1	1
2 Medium Lasers	CT	2	2
Jump Jets	RT	2	2
Jump Jets	LT	2	2

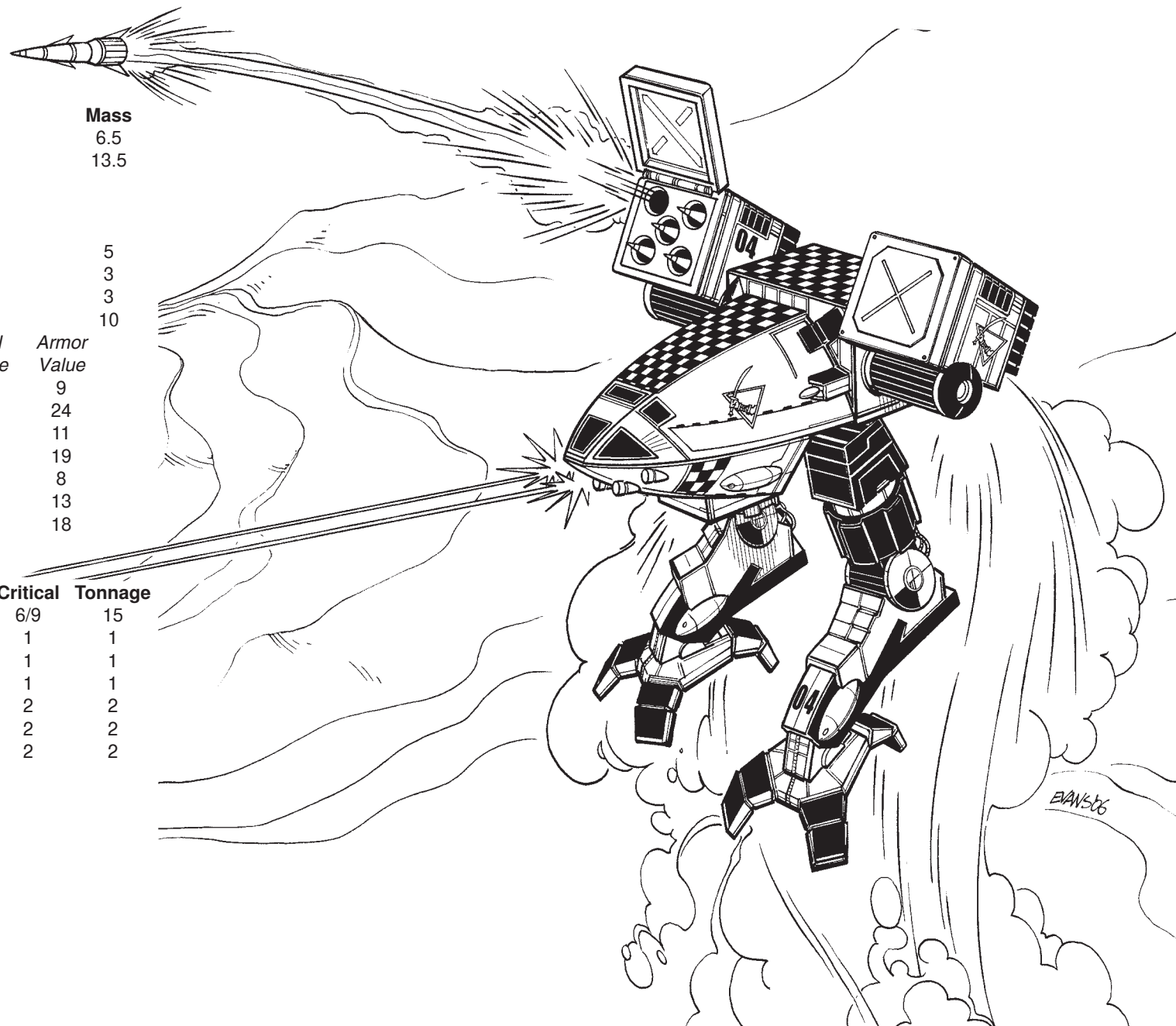

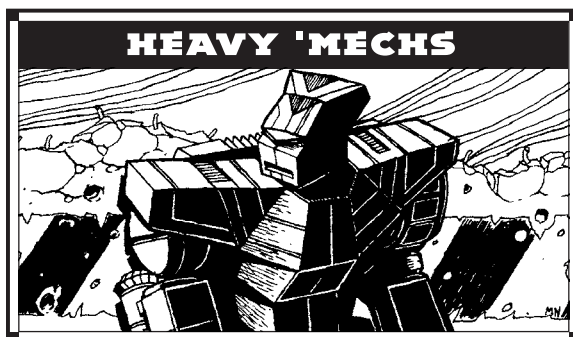

**Mass:** 65 tons

**Chassis:** Kallon Type XII

**Power Plant:** Magna 260 XL

**Cruising Speed:** 43 kph

**Maximum Speed:** 64 kph

**Jump Jets:** None

**Jump Capacity:** None

**Armor:** Kallon Unity Weave Ferro-Fibrous with CASE

**Armament:**

2 General Motors Nova-5 Autocannons

2 Mydron Model D Light Autocannons

2 Sutel Precision Line Medium Pulse Lasers

**Manufacturers:** Kallon Weapon Industries,  
Independence Weaponry

**Primary Factories:** Talon (Kallon,  
destroyed in 3069), Quentin (Independence)

**Communications System:** Garrett T11-A

**Targeting and Tracking System:** Garret D2j

## Overview

Like the *Enforcer*, the *JagerMech* is a BattleMech that has long been fundamentally associated with House Davion and its Federated Suns. It is also a 'Mech that, despite its value as a ranged fire-support unit, had long been in desperate need of a redesign to make it more survivable on the battlefield. That redesign finally came in the months prior to the calamitous Clan invasion.

## Capabilities

The redesigned *JagerMech* is still, at its heart, the same fire-support BattleMech it has always been, just with a lostech edge it had not possessed before. Now

equipped with an extralight fusion engine, the new *JagerMech* gained back the mass it needed to mount heavier class-5 Ultra autocannons and medium pulse lasers in place of the standard versions it once carried.

More importantly, that switch gave the design team the opportunity to not only mount additional ferro-fibrous armor but to protect its vulnerable ammunition magazines with CASE. This new *JagerMech* carries on average twenty percent more armor and, though it would likely still be incapacitated by an ammunition explosion, it would no longer be completely destroyed. As it turned out, it would need that increased survivability when the Clans began slicing through the Inner Sphere.

## Deployment

Following the Fourth Succession War, Kallon Weapon Industries negotiated a licensing agreement that allowed Independence Weaponry on Quentin to also build new *JagerMechs* for the AFFS. Unfortunately, that world was lost to the Draconis Combine during the War of 3039, sending *JagerMechs* flowing into the rapidly expanding Kurita military. Following Jaime Wolf's summit in late 3050, Prince Hanse Davion agreed to provide Theodore Kurita with the technical specifications of the upgraded *JagerMech*. As a result, the 'Mech saw significant action along both flanks of the Clan advance.

In the years since, brand-new and refit *JagerMechs* have been shipped to nearly every BattleMech regiment in the Draconis Combine and the former Federated Commonwealth, where they stand beside newer designs like the *Gunslinger* or *Thunder Hawk*, and even missile boats such as the *Longbow* and *Salamander*. Retaining the superior Garret D2j targeting system, the *JagerMech* remains an outstanding anti-air platform, especially when teamed with like-equipped *Riflemen* or Partisan tanks.

## Variants

The *JagerMech* is unique in that it has three major lines of variants. This first line includes field refits, the second is a ground-up redesign and re-imagining resulting from Archon-Prince Victor's "Redesign for Davion Pride" initiative, and the third is an upgraded (and up-tonnaged) outgrowth of that initiative.

The DG and H models belong to the first line. The former is a product of inventive techs working on *JagerMechs* undergoing major overhaul; they replaced all four autocannon with a pair of Gauss rifles and downgraded the pulse lasers to standard versions (later, ER models). The latter saw use following the Marian Hegemony's invasion of the Illyrian Palatinate, mounting paired LB 2-X autocannon and large lasers along with a fusillade of unguided rocket launcher pods.

The so-called *JagerMech III*, detailed in a different volume, belongs to the second line, while the JM7 series belong to the third. Massing five tons more and carrying nearly double the armor protection, these assault *JagerMechs* have gained significant popularity. All mount paired autocannon of some sort, the original D with the same ultra guns of the DD along with a battery of lasers, the F with heavy rotary autocannon and two back-up lasers tied to a targeting computer, and the G with both light rotary and LB-X autocannons backed by two ER lasers.

## Notable MechWarriors

**Archon Peter Steiner-Davion:** The Lyran Archon was just a young lieutenant in the FedCom's Skye March Militia when he found himself embroiled in a controversy devised by Ryan Steiner; information only recently come to light. Assigned to Lyons, he led his lance against a suspected Free Skye stronghold in the town of Bellerive. The town was destroyed, as it was later discovered, by Free Skye separatists looking to blame Steiner-Davion for the crime. Following that, he sequestered himself on Zaniah for a decade before re-emerging to lead the final attack on Tharkad during the FedCom Civil War (though keeping his *JagerMech* in reserve).

**Subaltern Davis Cheung:** Having just graduated from the Albion Military Academy, Subaltern Davis Cheung pilots the same *JagerMech* for the Second Davion Guards that his mother did during the Third and Fourth Succession Wars and the War of 3039. Still in mint condition after his mother spent years refurbishing it, his *JagerMech* has kept him safe through his battles with the Dragon on Kentares and beyond.

# JM6-DD JAGERMECH

Type: **JagerMech**

Technology Base: Inner Sphere

Tonnage: 65

Battle Value: 965

## Equipment

Internal Structure:

Engine:

Walking MP:

Running MP:

Jumping MP:

Heat Sinks:

Gyro:

Cockpit:

Armor Factor:

260 XL

4

6

0

10

116

Internal  
Structure

Armor  
Value

Head

3

9

Center Torso

21

18

Center Torso (rear)

5

R/L Torso

15

17

R/L Torso (rear)

5

R/L Arm

10

8

R/L Leg

15

12

## Mass

6.5

7

0

3

3

6.5

## Weapons

### And Ammo

Location

Critical

Tonnage

Ultra AC/5

RA

5

9

AC/2

RA

1

6

Ultra AC/5

LA

5

9

AC/2

LA

1

6

Medium Pulse Laser

RT

1

2

Ammo (Ultra) 20

RT

1

1

Ammo (AC) 45

RT

1

1

CASE

RT

1

.5

Medium Pulse Laser

LT

1

2

Ammo (Ultra) 20

LT

1

1

Ammo (AC) 45

LT

1

1

CASE

LT

1

.5

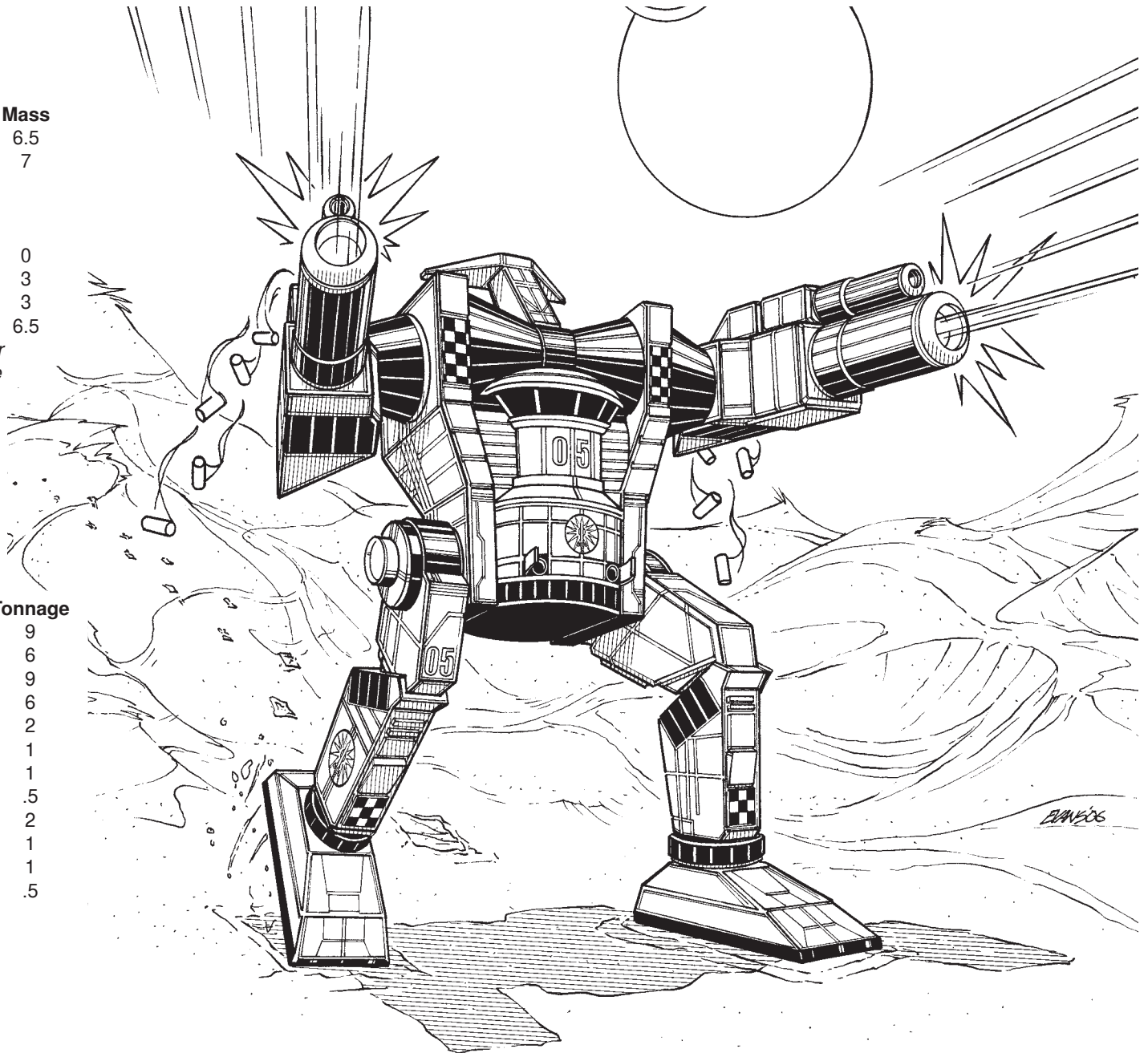

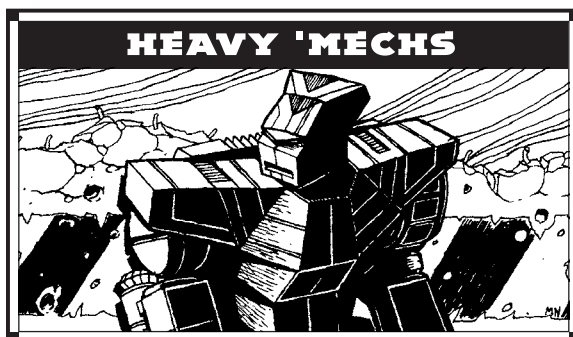

**Mass:** 70 tons

**Chassis:** Dorwinion CES Standard

**Power Plant:** GM 280 Extralight

**Cruising Speed:** 43 kph

**Maximum Speed:** 64 kph

**Jump Jets:** None

**Jump Capacity:** None

**Armor:** Kallon Royalstar with CASE

**Armament:**

1 Poland Main Model A Gauss Cannon

1 Johnston High Speed Long-Range  
Particle Projection Cannon

4 Sutel Precision Line Medium Pulse Lasers

**Manufacturer:** Johnston Industries

**Primary Factory:** New Syrtis

**Communications System:** Johnston Wide Band

**Targeting and Tracking System:** Randar Pinpoint-HY

## Overview

Originally based upon a reverse-engineered *Cataphract*, the Caesar was designed by Johnston Industries to hide the development of the *Axman*. While the *Caesar* turned out to be a quality 'Mech in its own right, sales never took off as expected. With other concerns, the line continued with mediocre sales until the conclusion of the Federated Commonwealth Civil War. The need to rebuild throughout the Inner Sphere led Johnston's marketing department to interview MechWarriors about the *Caesar*. By far the majority agreed that the *Caesar* was a good but not a great 'Mech. To this end, Johnston is seeking to invigorate *Caesar* sales with a pair of new variants.

## Capabilities

Armed with a Gauss rifle and extended-range PPC, the *Caesar* boasts good long-range firepower with decent mobility. Four medium pulse lasers, two forward and two rear, are added for short-range protection. The strongest point of the *Caesar* is its heat dissipation, allowing the 'Mech to enter a melee firing all its weapons with hardly any heat build up. This makes it a popular choice in missions to areas of extremely high temperatures.

## Deployment

Most *Caesars* were sold to the Federated Commonwealth. While produced in the Capellan March, the 'Mech was equally popular with the Lyran side, with smaller sales made to mercenaries working for the FedCom as well as the Com Guards. While the Civil War took a toll on the *Caesars*, there are still plenty operating near the Clan and Capellan borders. The *Caesar* was very successful in operations against the Clans—units found that if they used both the *Falconer* and the *Caesar*, the similar weapon load could often be used to confuse the enemy.

The *Caesar's* most glowing success was in the Adnan Wastes on Dustball. With temperatures that reduced heat sinks to half efficiency, the *Caesar* was able to maintain consistent fire with its primary weapons while Clan units often had weapons that were essentially useless or 'Mechs carrying loads that were not suited for non-energy based weaponry. The recent upswing in sales has spread the 'Mech out to all the opponents of the Word of Blake, especially in the Lyran Alliance where Caesar Steiner's rise to prominence—and recent assassination—has made the *Caesar* what the *Victor* was in the Federated Commonwealths heyday.

## Variants

Johnston's two most recent variants have been greeted well by MechWarriors. By focusing on their two main markets, the Lyran Alliance and the Federated Suns, designers used technology and weapon loads that would appeal not only to the warriors but also the quartermasters. The CES-3S is intended primarily for Lyran sales and uses a light engine for increased durability and a cheaper price tag at the cost of increased

weight. To offset this, four heat sinks are removed, and an endo-steel chassis and light ferro-fibrous armor are used. The Gauss rifle and arm-mounted pulse lasers remain but the PPC is upgraded to the heavy version. The rear firing lasers are replaced with a center-mounted ER small laser, while ECM equipment has been installed beneath the Gauss rifle.

For the AFFS, Johnston increased the mobility in the new CES-4R with myomer acceleration signal circuitry. The popular Poland Main Model A remains, but the PPC has been changed to a snub-nosed version for better short-range firepower. The rear firing lasers have again been removed and replaced with a center mounted ER medium and two forward firing ER medium lasers were added. This required the removal of three heat sinks, though an additional ton of armor was added and it was upgraded to ferro-fibrous.

## Notable MechWarriors

**Lt. Hannah McQuarters:** McQuarters and her *Caesar*, "*Gertrude*," helped the First Kestrel Grenadiers secure a victory over Nanking SMM during the Civil War. Having replaced her medium pulse lasers with eight forward firing extended versions, she would bait enemy units into closing and then unleash the searing barrage. This was extremely successful in the battle of Huai River Valley, when a lance of Nanking SMM 'Mechs found her alone and managed to cave her right side in with long-range firepower. The enemy believed *Gertrude* was down to basically short-ranged weaponry when McQuarters caught them off guard, killing a *Whitworth* and *Griffin* when they closed to medium range. As the remaining two *Blackjacks* attempted to withdraw, their weak back armor proved a tempting target and the cause of their demise. Yvonne Davion presented McQuarters with a new CES-4R along with her Federated Commonwealth Star, as *Gertrude* did not survive the Civil War.

# CES-3R CAESAR

Type: **Caesar**

Technology Base: Inner Sphere

Tonnage: 70

Battle Value: 1,578

## Equipment

Internal Structure:

Engine: 280 XL

Walking MP: 4

Running MP: 6

Jumping MP: 0

Heat Sinks: 16 [32]

Gyro: 3

Cockpit: 3

Armor Factor: 168

	Mass	Armor Value
Internal Structure	7	9
Engine	8	26
Head	3	7
Center Torso	22	15
Center Torso (rear)	7	6
R/L Torso	15	21
R/L Torso (rear)	6	21
R/L Arm	11	21
R/L Leg	15	21

## Weapons and Ammo

	Location	Critical	Tonnage
Gauss Rifle	RT	7	15
Ammo (Gauss) 16	LT	2	2
CASE	RT	1	.5
ER PPC	RA	3	7
Medium Pulse Laser	LA	1	2
Medium Pulse Laser	RA	1	2
Medium Pulse Laser	LT (R)	1	2
Medium Pulse Laser	RT (R)	1	2

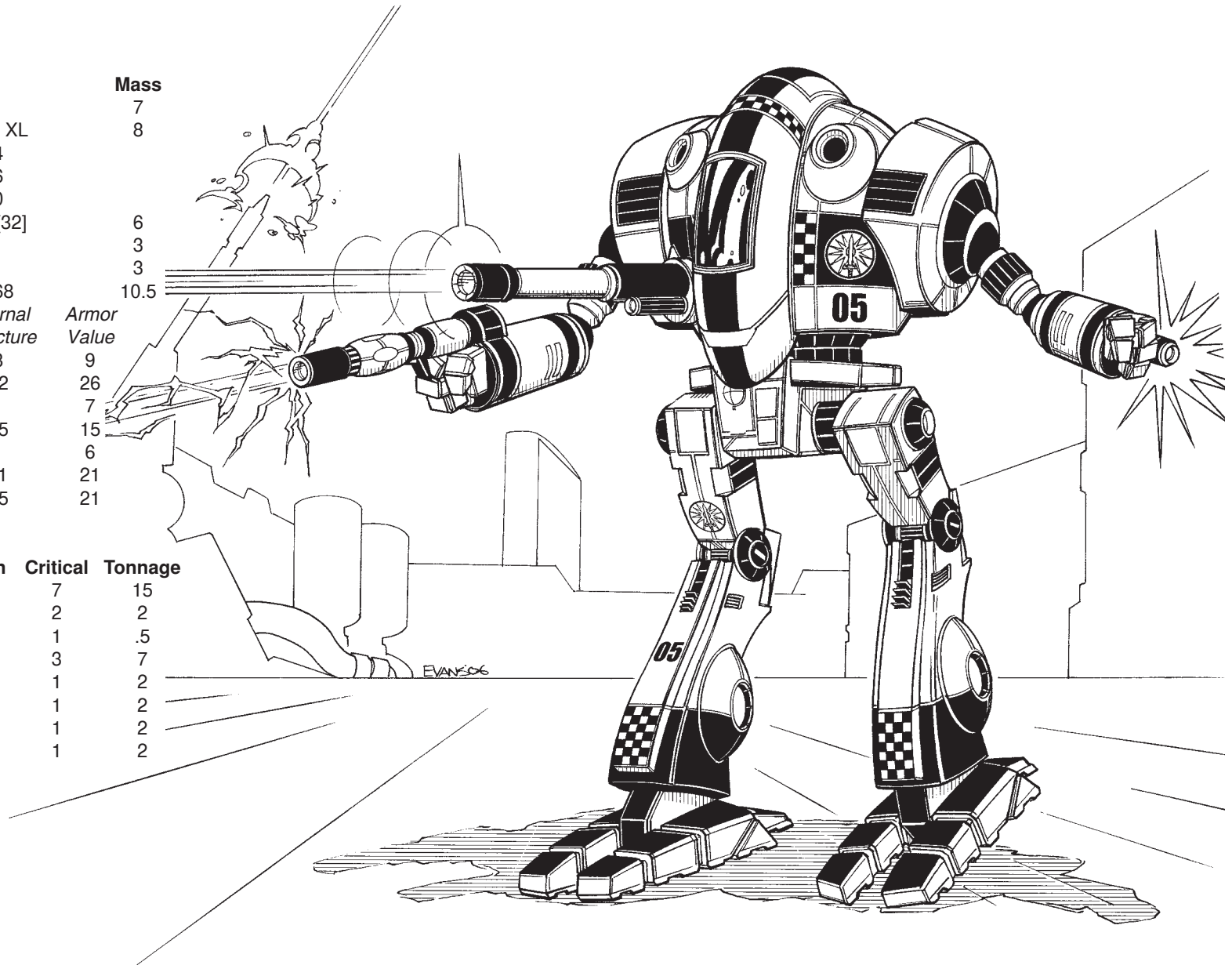

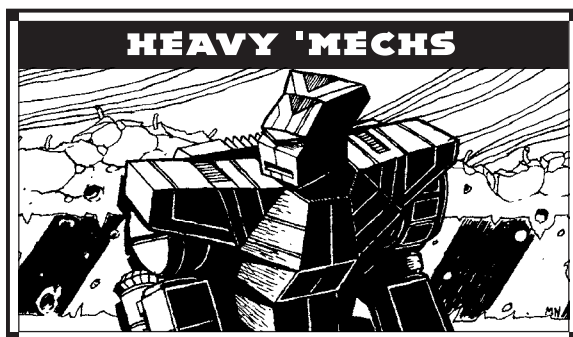

**Mass:** 70 tons

**Chassis:** Earthwerk CTF

**Power Plant:** 280 GM XL

**Cruising Speed:** 43 kph

**Maximum Speed:** 64 kph

**Jump Jets:** HildCo Model 12

**Jump Capacity:** 120 meters

**Armor:** Kallon Royalstar with CASE

**Armament:**

1 Mydron Excel LB 10-X AC

1 General Motors Nova-5 Ultra AC/5

4 Intek Medium Lasers

**Manufacturer:** Earthwerks Incorporated

**Primary Factory:** Tikonov

**Communications System:** CommuTech

Multi-Channel 10

**Targeting and Tracking System:** BlazeFire Sightlock

## Overview

Once a mere handful of prototypes, the *Cataphract* was originally an experimental design that started production in limited quantities for the Confederation until the loss of its plant in the Fourth Succession War to House Davion. Intended to stand toe-to-toe with assault BattleMechs, it was instead relegated to the Capellan March Militia, obviously to goad Romano Liao.

When the Clan Invasion occurred, everything changed. Every BattleMech design in production was rushed to be upgraded and sent to the front lines. Hanse Davion authorized the allocation of resources to upgrade the *Cataphract*. Romano's agents stole one of the discarded design ideas, and after slight adjustments used it for the incomplete facility on Grand Base.

## Capabilities

The CTF-3D *Cataphract* at first glance seems to be an early attempt to make a heavy BattleMech as versatile as possible. Using the freed-up weight from an extra-light GM Fusion engine, the Commonwealth engineers gave it a distinctively Davion flavor, mounting jump jets and dual autocannons. Mounted on the right arm, the high-speed GM Ultra cannon gives the *Cataphract* credible long-range firepower, while the torso mounts the larger and vastly more popular Mydron LB. Many pilots have testified to the superiority of the LB-series autocannon, as it gives them a lethal weapon when attempting anti-conventional and anti-aircraft duties, without the possibility of jamming. Four medium lasers give it weapons coverage in all arcs.

## Deployment

While the 3D *Cataphract* saw marginal deployment throughout the Federated Commonwealth, the 3L variant made up twenty-five percent of all of the CCAF's newly acquired heavy BattleMech designs during the '50s. It was not until the Xin Sheng resurgence that the *Cataphract's* footprint shrank, only to resurface again in the late 3060s with the stealth-armor equipped 4L, intended for the Shadow Lances.

## Variants

The Confederation began producing its own version about the same time as the upgraded Davion version, thanks to the completion of the new plant on Grand Base. This 3L model uses an ER PPC instead of an Ultra autocannon, pulses instead of standard medium lasers, and double heat sinks. Instead of jump jets, the Grand Base models employ a MASC system to provide a burst of speed when needed.

With the Xin Sheng movement and the recapture of Tikonov, Sun Tzu ended the production of the 3D and ordered the retooling of the line to produce the more advanced 4L model. Designed for the growing amount of Shadow Lances within the CCAF, this model carries ER lasers and a Gauss rifle protected by the highly guarded stealth armor.

As the rebuilding of New Syrtis began after the Capellan counter invasion, the large amount of salvage has allowed the extremely limited ability to produce

stealth armor. The 5D *Cataphract*, produced to replace combat losses, is equipped with a cramped cockpit, and this model uses the newly acquired plasma rifle alongside a light autocannon backed by a pair of ER medium lasers. Improved jump jets are mounted to give the heavy BattleMech an edge in mobility, while a light fusion engine provides sufficient power.

Also being used are the small stockpiles of 4X *Cataphracts*. Produced for a limited run right after the Fourth Succession War, they were quickly mothballed by House Davion due to its lackluster reception. Slowing down by twenty-five percent, the 4X compensated by mounting a trio of equally sized weapons, a single large laser and a pair of AC/5s. Ironically these are better received today than they were decades ago, as the new autocannon munitions have drastically increased the lethality of the standard guns. An LRM-5 rack was added as an afterthought.

## Notable Pilots:

**Sergeant Sara Lytton-McKinnon:** Members of the Lytton family have traditionally served the McKinnons—the hereditary commanders of the Fox's Teeth Company—as bodyguards for over two centuries. Following the death of her father on Wotan in 3051 while saving his captain from the Jade Falcons, and Ian McKinnon's retirement later that year, Sara followed the family custom and became Ross McKinnon's bodyguard. With her own *Commando* destroyed in the battle against the Falcons, Sara inherited her dead father's salvaged *Cataphract*. Acquired during the Fourth Succession War—when the Seventh Crucis Lancers captured the Tikograd factories on Tikonov—"Lucky Thirteen" was one of the first *Cataphracts* off the production line. Despite possessing numerous quirks, both from the 'Mechs prototypical nature and later its experimental equipment, the 'Mech has served the Lytton's and McKinnon's Raiders well throughout the years.

# CTF-3D CATAPHRACT

Type: **Cataphract**

Technology Base: Inner Sphere

Tonnage: 70

Battle Value: 1,325

## Equipment

Internal Structure:

Engine: 280

Walking MP: 4

Running MP: 6

Jumping MP: 4

Heat Sinks: 16

Gyro: 3

Cockpit: 3

Armor Factor: 176

Internal Structure	Armor Value
--------------------	-------------

Head	3	9
------	---	---

Center Torso	22	26
--------------	----	----

Center Torso (rear)		9
---------------------	--	---

R/L Torso	15	16
-----------	----	----

R/L Torso (rear)		9
------------------	--	---

R/L Arm	11	22
---------	----	----

R/L Leg	15	19
---------	----	----

## Mass

7

8

6

3

3

11

## Weapons and Ammo

Location	Critical	Tonnage
----------	----------	---------

LB 10-X AC	RT	6	11
------------	----	---	----

Ammo (LB-X) 20	LT	2	2
----------------	----	---	---

CASE	LT	1	.5
------	----	---	----

Ultra AC/5	RA	5	9
------------	----	---	---

Ammo (Ultra) 20	RT	1	1
-----------------	----	---	---

CASE	RT	1	.5
------	----	---	----

Medium Laser	LT (R)	1	1
--------------	--------	---	---

Medium Laser	RT (R)	1	1
--------------	--------	---	---

Medium Laser	RA	1	1
--------------	----	---	---

Medium Laser	LA	1	1
--------------	----	---	---

Jump Jets	RL	2	2
-----------	----	---	---

Jump Jets	LL	2	2
-----------	----	---	---

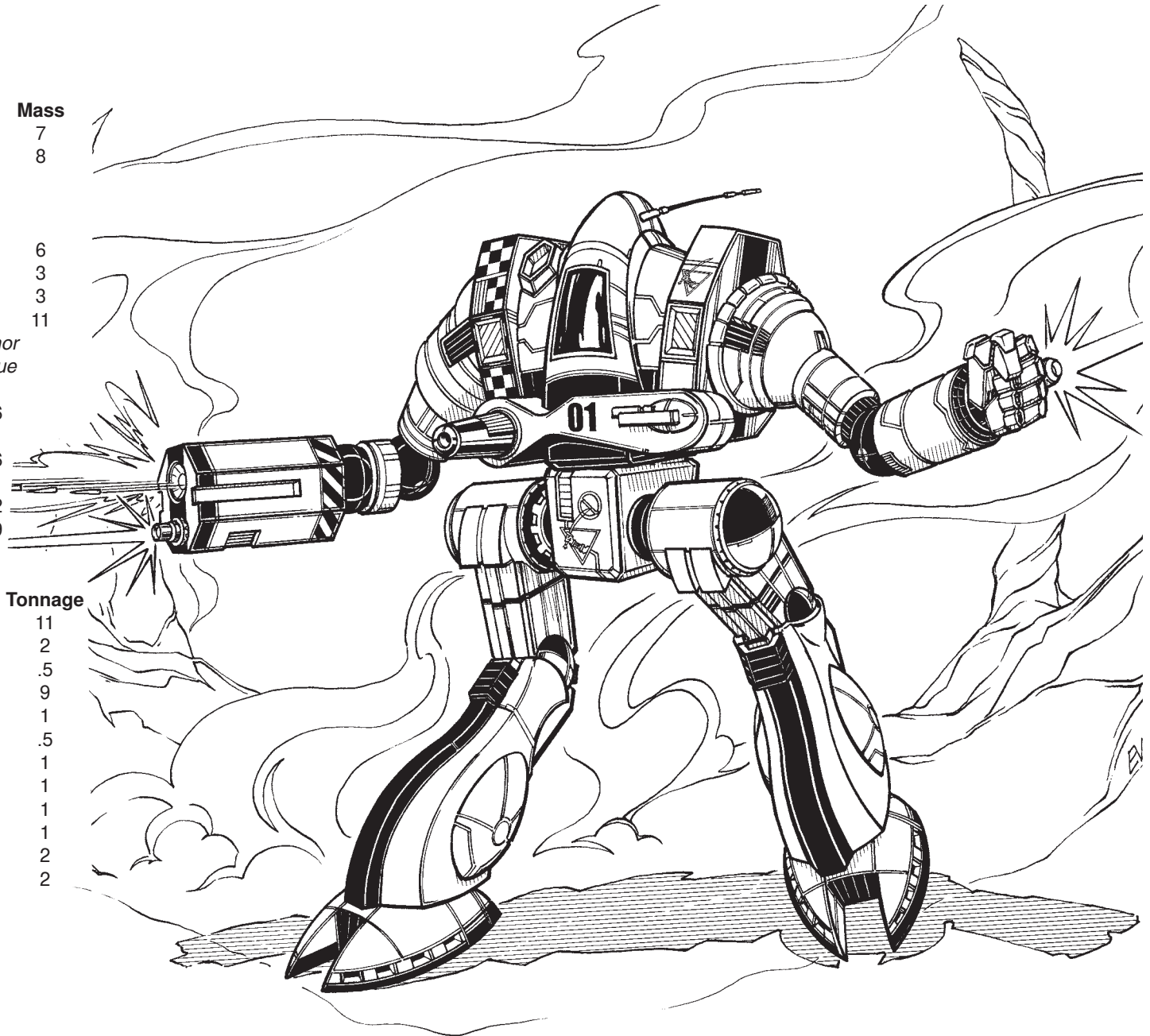

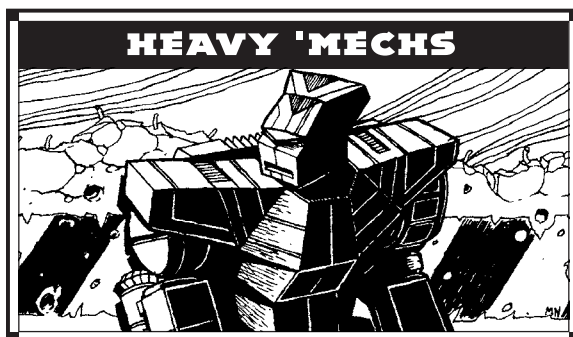

**Mass:** 70 tons  
**Chassis:** Mingh z33/7  
**Power Plant:** VOX 280  
**Cruising Speed:** 43 kph  
**Maximum Speed:** 64 kph  
**Jump Jets:** Leviathan Lifters  
**Jump Capacity:** 120 meters  
**Armor:** Durallex Heavy  
**Armament:**

- 1 Diverse Optics Sunbeam Extended-Range Large Laser
- 2 Diplan M3 Medium Lasers
- 1 Hovertec Streak SRM-2 Pack
- 1 SureFire 444 Anti-Missile System

**Manufacturer:** Lantren Corporation  
**Primary Factory:** Bryant  
**Communications System:** Allet-C308  
**Targeting and Tracking System:** Allet-T11

## Overview

Envisioned as a highly mobile close-range fighter, the *Grasshopper* was one of the last 'Mechs designed for the SLDF during the Amaris Civil War. However, numerous delays in production meant the design did not enter service until 2780, after the fighting had ended. By 2784 most Regular Army regiments had received a number of the as-yet untested 'Mechs, though the chaos of Kerensky's Exodus and the defection of regular army units to the various House Lords proliferated the design throughout the Inner Sphere.

The First Succession War proved to be the crucible that forged the *Grasshopper's* reputation as a premier 'Mech for storming fortifications, as its mobility and endurance often led it to spearhead such assaults.

## Capabilities

Out of production since the Second Succession War due to Bryant's ever-worsening global storms, the GHR-5J is merely an upgrade of the Star League-era GHR-5H. The old Diplan heavy laser is replaced with a Diverse Optics Extended-Range Sunbeam model, which improves the 'Mech's reach by over 25 percent. The Conan/S LRM-5 is exchanged for a Hovertec Streak-2 pack, which further augments the 'Mech's short-range firepower and retains the design's independence from supply lines. Lastly, the two torso-mounted medium lasers were exchanged for a SureFire 444 anti-missile system.

## Deployment

In widespread use throughout the Inner Sphere, the *Grasshopper* is a favorite of mercenaries and other units who value its self-reliance on extended missions, due to its minimal ammunition requirements. It is particularly prized for its superior mobility, as the Leviathan Lifters give the *Grasshopper* the ability to outflank heavier opposing 'Mechs; though common amongst medium and light 'Mechs, few heavier designs possess such mobility. Tactics change when *Grasshoppers* enter the battlefield.

Recent reports from New Avalon mention a flat black *Grasshopper* terrorizing Word units. Feared for its blistering all-energy payload, the 'Mech often finishes off its opponents with TSM-enhanced physical assaults or unerringly accurate death-from-above maneuvers.

## Variants

Another field variant of the 5H, the GHR-5N removes the LRM-5 and uses the freed-up mass to replace the large laser with a PPC and another medium laser. Increased firepower at improved ranges is traded with the risk of a careless MechWarrior overheating the BattleMech.

First seen in the Draconis Combine, the GHR-C is a simple modification of the 5J that drops a ton of Streak ammunition for a C<sup>3</sup> slave unit. This variant makes for an ideal point 'Mech in C<sup>3</sup>-equipped formations, as its jump jets and respectable armor allow it to close with a target in relative safety and deliver target-

ing information to its lance mates. The removal of the ammunition leads to no drop in performance as the Hovertec Streak is already famously ammo thrifty, making this a popular upgrade.

With the growing reputation of the *Grasshopper* within the Combine, LexaTech Industries of Hun Ho decided to expand their portfolio of products with a ground-up redesign of the 'Mech during the 3060s, the GHR-6K. The 6K features nearly all-new weaponry and an endo-steel chassis. The ER large laser remains, but five medium pulse lasers dot the arms and torsos of the 'Mech. The traditional *Grasshopper* missile launcher is a Guided Technologies 2nd Generation Streak SRM-4 with one ton of CASE-protected ammunition. Seventeen double heat sinks keep the 'Mech frosty, and a C<sup>3</sup> slave provides enhanced-targeting data to lance-mates.

The fires of the Jihad also spurred production of another variant of the 'Mech, the GHR-7K. Designed to be entirely free of the oft-unreliable supply lines that would hobble ammo-dependant 'Mechs, the 7K excels as both a raider and guerilla fighter. Twin arm-mounted light PPCs provide the 'Mech's long-range sting and the two torso-mounted snub-nose PPCs deliver tremendous firepower at closer quarters. A C<sup>3</sup> slave and Guardian ECM add to its functionality while a head-mounted ER medium laser rounds out the design.

Rumors abound that the Bryant plant may not be as lost as previously thought, as higher-than-expected concentrations of *Grasshoppers* have been observed in Word of Blake forces.

## Notable MechWarriors

**Major Aaron Pollyea:** Attached to the NAIS, Major Aaron Pollyea escaped the destruction of the complex in December 3068 with help from survivors of the New Avalon Cavaliers. Leading one of the many resistance cells based on New Avalon, Pollyea and his 'Mech "*Gravedigger*"—a captured Kuritan prototype - 7K model undergoing testing and modification at the NAIS—can often be found ambushing WoB patrols through the ruins of New Avalon's cities and leading commando-style raids against "the robes."



# GHR-5J GRASSHOPPER

Type: **Grasshopper**

Technology Base: Inner Sphere

Tonnage: 70

Battle Value: 1,354

## Equipment

Internal Structure:

Engine: 280

Walking MP: 4

Running MP: 6

Jumping MP: 4

Heat Sinks: 22

Gyro: 3

Cockpit: 3

Armor Factor: 208

## Mass

7

16

	Internal Structure	Armor Value
--	--------------------	-------------

Head	3	9
------	---	---

Center Torso	22	30
--------------	----	----

Center Torso (rear)		13
---------------------	--	----

R/L Torso	15	20
-----------	----	----

R/L Torso (rear)		10
------------------	--	----

R/L Arm	11	22
---------	----	----

R/L Leg	15	26
---------	----	----

## Weapons and Ammo

	Location	Critical	Tonnage
--	----------	----------	---------

ER Large Laser	CT	2	5
----------------	----	---	---

Medium Laser	RA	1	1
--------------	----	---	---

Medium Laser	LA	1	1
--------------	----	---	---

Streak SRM 2	H	1	1.5
--------------	---	---	-----

Ammo (Streak) 100	RT	1	2
-------------------	----	---	---

Anti-Missile System	RT	1	.5
---------------------	----	---	----

Ammo (AMS) 12	LT	1	1
---------------	----	---	---

Jump Jets	RL	2	2
-----------	----	---	---

Jump Jets	LL	2	2
-----------	----	---	---

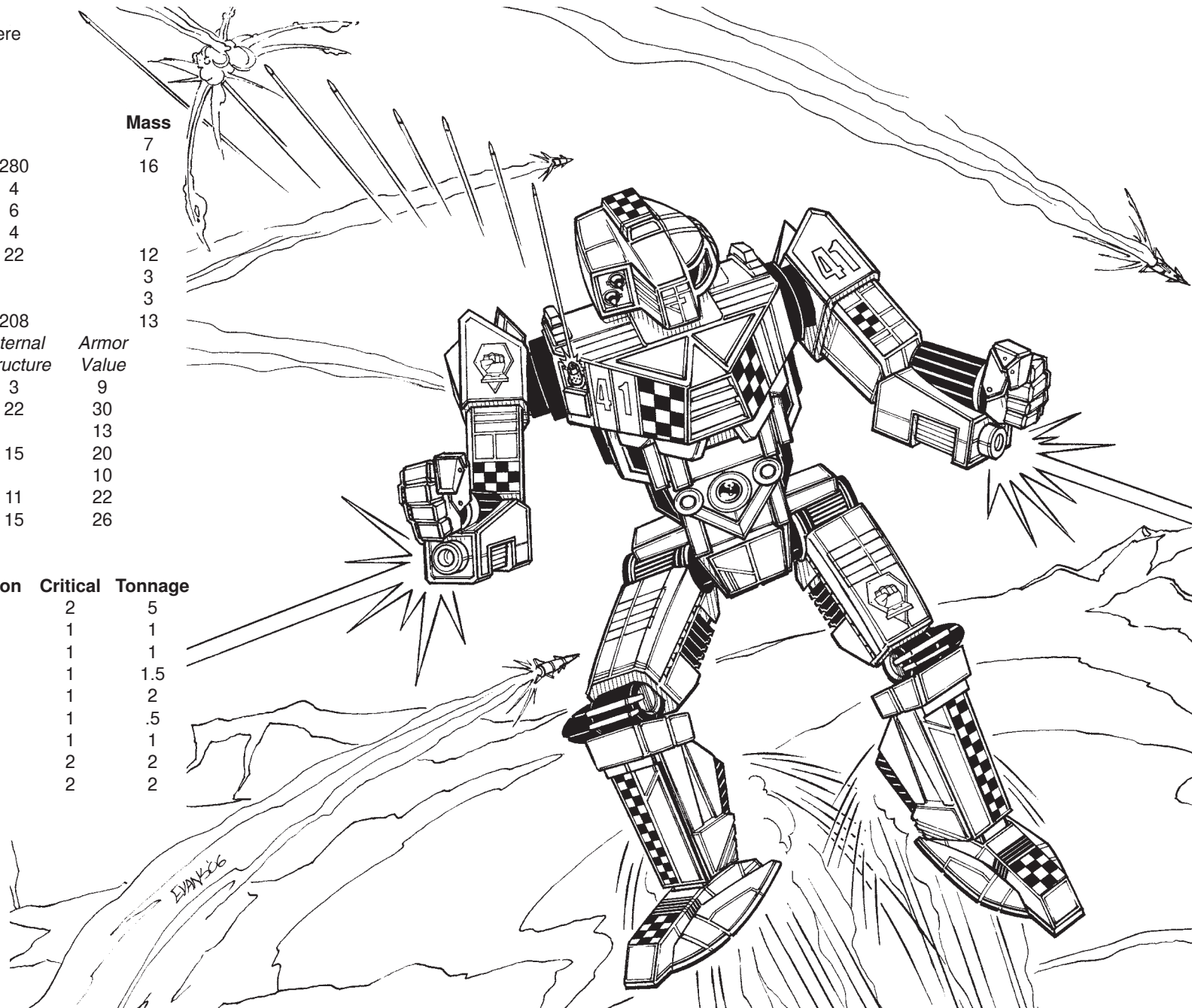

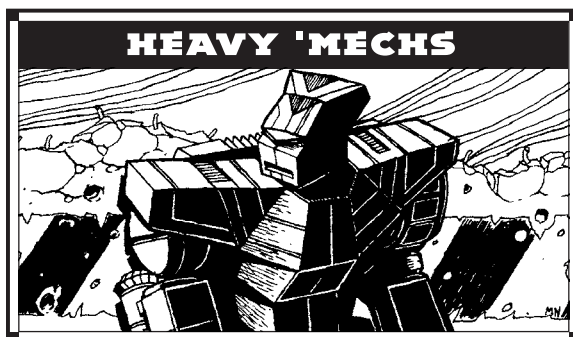

**Mass:** 75 tons

**Chassis:** Kali Yama Chassis

**Power Plant:** Hermes 300 XL

**Cruising Speed:** 43 kph

**Maximum Speed:** 64 kph

**Jump Jets:** None

**Jump Capacity:** None

**Armor:** Valiant Lamellor with CASE

**Armament:**

- 1 Kali Yama Weapons Industries LB 10-X AC
- 1 Kali Yama Weapons Industries Type V LRM 20
- 1 Irian Weapons Works Class 4 SRM
- 1 Octagon Missile Magnet Narc Missile Beacon
- 2 Irian Weapons Works Medium Lasers

**Manufacturer:** Kali Yama/Alphard Trading Corp.

**Primary Factory:** Kendall, Kalidasa

**Communications System:** Irian Orator-5K

**Targeting and Tracking System:** Wasat Aggressor  
Type 5

## Overview

Though in production for well over 500 years, the *Orion* remains a mainstay of the Free World's heavy 'Mech forces, as its mix of firepower and resilience appeals to a wide range of MechWarriors. Over the centuries countless thousands have poured off the production line, but the last two decades have seen something of a renaissance for the *Orion* as the inclusion of recovered technologies has allowed the design to push its way to the forefront of the FWLM's military exports.

## Capabilities

Spearheaded by the Alphard Trading Corporation, the redesign of the *Orion* traded an LB 10-X for the temperamental autocannon of the previous model, backed by missile launchers capable of working in conjunction with the design's Octagon NARC missile beacons. An XL engine and double-efficiency heat sinks allow the *Orion* to employ its weaponry to good effect with little worry of overheating.

The new configuration's baptism of fire came during the 3057 liberation of FWL worlds lost to the Federated Commonwealth though the first significant test of the design came a year later during the Jade Falcon incursion to Coventry, where a number of export models were employed by the Lyrans.

## Deployment

A mainstay of the FWL for centuries, the number of *Orions* appearing outside the Free Worlds was limited despite the design being of Star League origins. That all changed with the deal struck on Outreach during the Clan invasion in which it was agreed that the Free Worlds' military-industrial complex would support the militaries of the other houses during the time of crisis. That agreement spurred companies like Kali Yama and the Alphard Trading Corporation into a golden age such as they'd not seen since the fall of the Star League, bringing vast wealth and manufacturing experience to the League companies.

## Variants

A side effect of the widespread deployment of the *Orion* is the plethora of variants that have emerged. Many are negligible modifications of the design—the employment of local components for a field repair or the relocation of a weapon to suit personal tastes—but others offer more radical alternatives to the base model; dropping the Octagon launcher in favor of Artemis FCS; replacing the LRM and SRM launchers with alternate designs including, in the DCMS, MRM-equipped models; removing the heavy LB-X and replacing it with a lightweight Gauss rifle or a rotary cannon.

The only build-to-order variant is the cool-running ON2-M configuration that radically overhauls the *Orion*'s

weaponry, employing all these changes; a Gauss rifle appears in lieu of the autocannon and a trio of medium pulse lasers provide close-in fire support, replacing the SRM launcher and the existing lasers. The LRM launcher is downgraded to a 15-tube launcher, but its efficiency is enhanced by the Artemis IV FCS that replaces the Narc Beacon system. To facilitate all these upgrades, the 2M's heat-dissipation systems are downgraded slightly, though under normal operating conditions the variant will not overheat.

## Notable MechWarriors

**General Aleksandr Kerensky:** Without doubt the most famous *Orion* pilot to have lived, Aleksandr Kerensky employed the design throughout the campaign in the Periphery and against Amaris. It was in his olive-drab machine that the general stormed Amaris' final defenses on Terra and in which he took the usurper and his family prisoner. After being stripped of his office and planning the Exodus, however, Kerensky abandoned the venerable machine, jettisoning it from the fleet before departing into the Periphery. There it languished among the scrap, lost for more than two centuries before being found by Combine salvage teams.

**Coordinator Theodore Kurita:** The young Theodore Kurita expected to begin his career in the *Dragon* provided by his father. He was thus shocked to receive a gift from his great-aunt Florimel, a venerable Star League-era *Orion*. It was a fine gift for a young officer, but its pedigree shifted this 'Mech into a league of its own: It was the same *Orion* Kerensky had employed. Discovered on an asteroid in the New Samarkand system, the 'Mech was nothing more than a shell, with its lostech parts removed or ruined, until it was reconditioned by the finest technicians in the Combine. Named "*Revenant*" by Theodore, the 'Mech served him well over the next ten years, particularly in his time with the Legion of Vega on Marfik. The 'Mech was reportedly destroyed on Marfik as the LCAF attempted to capture the prince in the early weeks of the Fourth Succession War, but Theodore himself escaped to take command of the counterattack into the Commonwealth.

Type: **Orion**

Technology Base: Inner Sphere

Tonnage: 75 tons

Battle Value: 1,414

### Equipment

Internal Structure:

Engine: 300 XL

Walking MP: 4

Running MP: 6

Jumping MP: 0

Heat Sinks: 11 [22]

Gyro: 1

Cockpit: 1

Armor Factor: 224

Internal Structure	Armor Value
Head	9
Center Torso	36
Center Torso (rear)	9
R/L Torso	22
R/L Torso (rear)	10
R/L Arm	21
R/L Leg	32

Head 3

Center Torso 23

Center Torso (rear)

R/L Torso 16

R/L Torso (rear)

R/L Arm 12

R/L Leg 16

### Mass

7.5

9.5

1

3

3

14

### Weapons and Ammo

	Location	Critical	Tonnage
LB 10-X AC	RT	6	11
Ammo (LB-X) 20	RT	2	2
CASE	RT	1	.5
LRM 20	LA	5	10
Ammo (LRM) 12	LT	2	2
CASE	LT	1	.5
SRM 4	LT	1	2
Ammo (SRM) 50	LT	2	2
Narc Missile Beacon	CT	2	3
Ammo (Narc) 12	LT	2	2
Medium Laser	LA	1	1
Medium Laser	RA	1	1

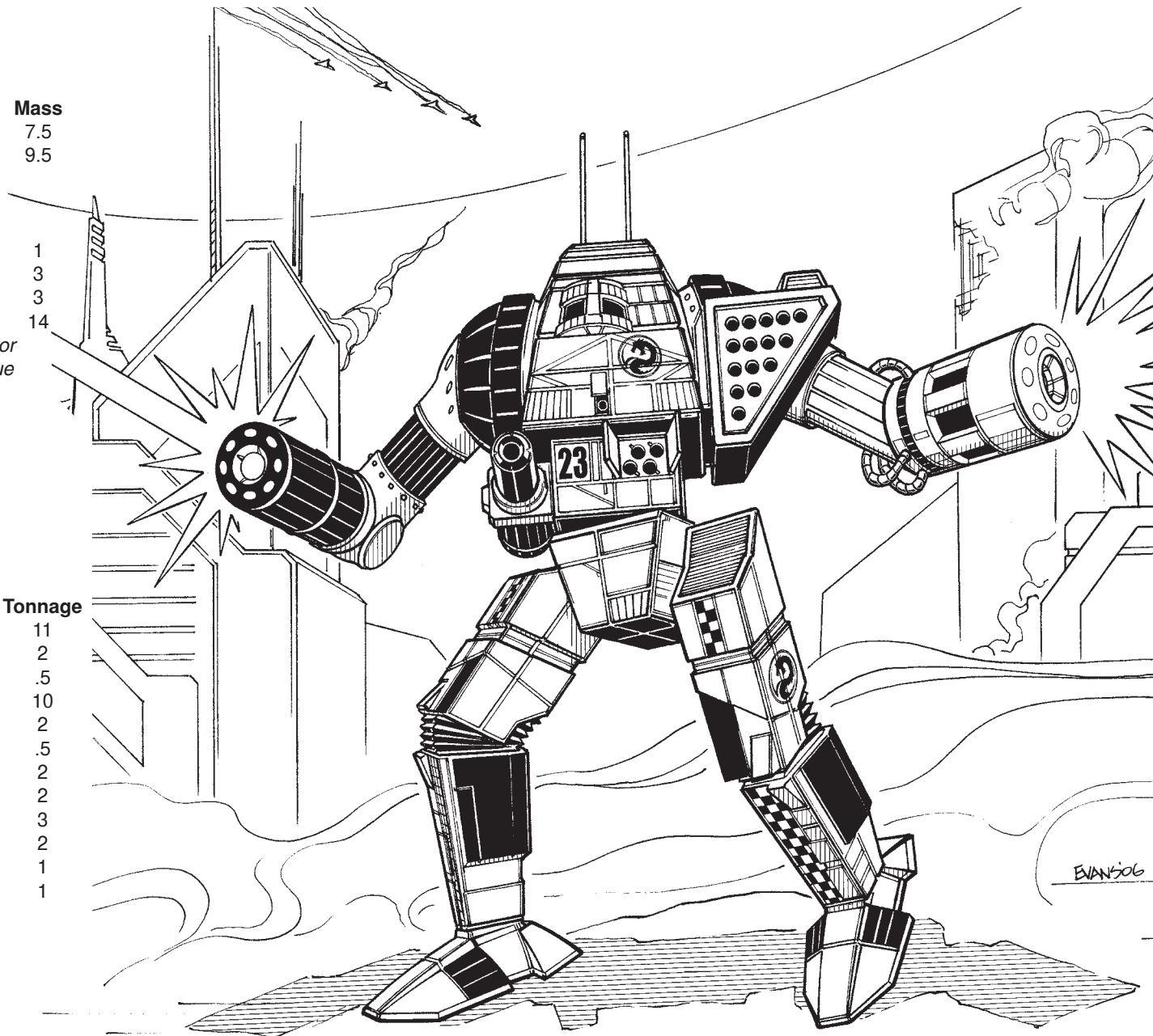

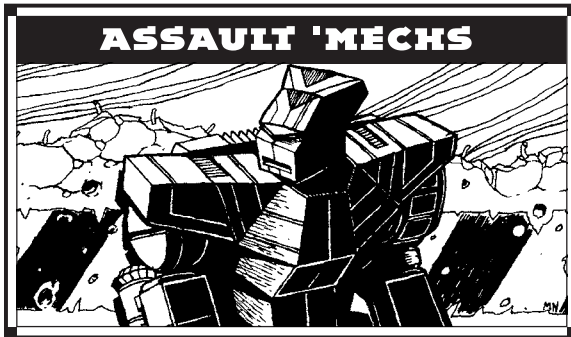

**Mass:** 80 tons

**Chassis:** Technicon Type G

**Power Plant:** Pitban 320 XL

**Cruising Speed:** 43 kph

**Maximum Speed:** 64 kph

**Jump Jets:** None

**Jump Capacity:** None

**Armor:** Durallex Heavy Special

**Armament:**

3 Fusigon Longtooth Extended-Range PPCs

1 Diverse Optics Type 10 Small Laser

1 Magna 400P Medium Pulse Laser

2 Hovertec Streak SRM-2 Pods

**Manufacturer:** Technicon Manufacturing,  
Irian BattleMechs Unlimited

**Primary Factory:** Savannah (Technicon),  
Irian (Irian)

**Communications System:** Garret T19-G

**Targeting and Tracking System:** Dynatec 2780

## Overview

First built in 2665 by the Technicon Manufacturing Conglomerate under license from the original Star League, the *Awesome* quickly proved to be one of the finest assault 'Mechs ever built. Its thick hide of fifteen tons of Durallex Heavy Special armor, combined with the firepower of three particle projector cannons wedded to a heat profile allowing for near-constant use, created a weapons platform to strike fear into the heart of any enemy commander.

## Capabilities

Technicon Manufacturing and Irian BattleMechs Unlimited were loath to modify such a successful de-

sign. However, as the 3050s dawned and the renaissance of technologies from the Helm Memory Core combined with the Clan invasion to spur upgrades of every prominent 'Mech throughout the Inner Sphere, they took the plunge.

Utilizing the latest weaponry available, the companies mounted three extended-range PPCs, a small and medium pulse laser and twin Streak SRM-2s, along with twenty double-heat sinks. Furthermore, the companies attempted to rectify one of the few complaints against the 8Q: its speed. They traded out the Pitban 240 for a Pitban 320 extra-light engine, allowing for speeds of about sixty-five kilometers an hour—a serious accomplishment for a machine of its weight class.

## Deployment

A plethora of variants are found in every Great House army; even most major Periphery states field the venerable AWS-8Q. Currently, the new AWS-10KM variant is exclusively fielded by the elite of House Marik and Kurita. Considering the 'Mech-weight-size contract for the production and shipment of this new design, it's highly doubtful even the wily Irian Technologies will find a loophole allowing them to sell the variant to another House, or even a mercenary unit.

## Variants

The AWS-9Q *Awesome*—which first appeared during Operation Guerrero—harkens back to the original AWS-8Q. While some critics scoffed at the mounting of standard PPCs in an age of the extended-range particle projector cannon, the 9Q proved devastatingly effective. Carrying standard quad PPCs and nineteen double-strength heat sinks in an eighty-ton chassis with heavy armor, the 9Q can deliver withering firepower for extended periods. The Guardian ECM suite and small laser are almost afterthoughts.

The AWS-10KM is a joint venture between Alshain Weaponry and Irian Technologies and is an obvious successor to the 8Q and 9Q designs. While AW brings their highly sought-after new PPC weaponry to the table, Irian Technologies adds their own impressive arsenal of cutting-edge technologies in the compact engine and gyro. The 10KM, in addition to the compact gyro and engines, utilizes endo-steel while mounting 18 double heat sinks, a Guardian ECM suite, twin heavy PPCs, and a snub-nose PPC. While the heat curve of

the 10KM is higher than either the 8Q or 9Q, the use of the compact engine and gyro and subsequent increase in battlefield survivability is well worth the trade-off.

## Notable MechWarriors

**Precentor Martial Cameron St. Jamais:** The most infamous *Awesome* pilot is none other than Cameron St. Jamais, Precentor Martial of the Word of Blake. Considered fanatical even in an organization defined by fanaticism, Cameron began his meteoric rise to his current station of power as head of the Sixth of June movement, a sub-sect of the powerful Toyama sect. What's more, St. Jamais was a member of the Blake's Wrath special forces, which almost by definition makes him an elite MechWarrior.

**Lieutenant Rodney Klatt:** Unlike so many war orphans left awash on the dirty streets of too many worlds or lost in the monstrous bureaucracy of the Lyran Commonwealth Civil Service, fate held an ace up the sleeve for Rodney Klatt. Washing up on the shores of Arc-Royal, Klatt stumbled into contact with one Jason Youngblood when he attempted to pick-pocket the Kell Hound officer. Instead of tossing the teenager back into the street, Youngblood pushed him into service with the Kell Hounds, where he eventually became good friends with Jason's son, Jeremiah; though Jason kept an eye on him, he never let a hint of favoritism mar Klatt's climb in status. When Lt. Colonel Akira Brahe decided to form an independent company to "deal with situations beyond the purview of the Kell Hounds," he contacted Jason to reform his Crescent Hawks (they had been absorbed by the Kell Hounds during the Clan invasion). While touched, Youngblood considered himself too old for young men's work and was content teaching Kell Hound cadets. Instead, he recommended his son, as well as Klatt. Jeremiah Youngblood assumed command at the helm of his father's 'Mech, completely upgraded to a PXH-7K status, while Klatt assumed an XO position with his slightly modified AWS-9Q that trades out the Guardian ECM Suite for a C<sup>3</sup> slave. Though unusual to have an assault 'Mech in a fast-strike unit, Jeremiah fully supports the move, considering Klatt's fire-power a necessary addition for their coming missions.

Type: **Awesome**

Technology Base: Inner Sphere

Tonnage: 80

Battle Value: 1,812

### Equipment

Internal Structure:

Engine: 320 XL

Walking MP: 4

Running MP: 6

Jumping MP: 0

Heat Sinks: 20 [40]

Gyro: 4

Cockpit: 3

Armor Factor: 247

### Mass

8

11.5

10

4

3

15.5

Internal Structure	Armor Value
Head	3
Center Torso	25
Center Torso (rear)	17
R/L Torso	17
R/L Torso (rear)	13
R/L Arm	13
R/L Leg	17

Head 3 9

Center Torso 25 30

Center Torso (rear) 17 20

R/L Torso 17 24

R/L Torso (rear) 13 10

R/L Arm 13 26

R/L Leg 17 34

### Weapons

#### and Ammo

Location	Critical	Tonnage
RA	3	7
RT	3	7
LT	3	7
H	1	1
CT	1	2
CT	1	1.5
LA	1	1.5
LL	1	1

ER PPC RA 3 7

ER PPC RT 3 7

ER PPC LT 3 7

Small Pulse Laser H 1 1

Medium Pulse Laser CT 1 2

Streak SRM 2 CT 1 1.5

Streak SRM 2 LA 1 1.5

Ammo (Streak) 50 LL 1 1

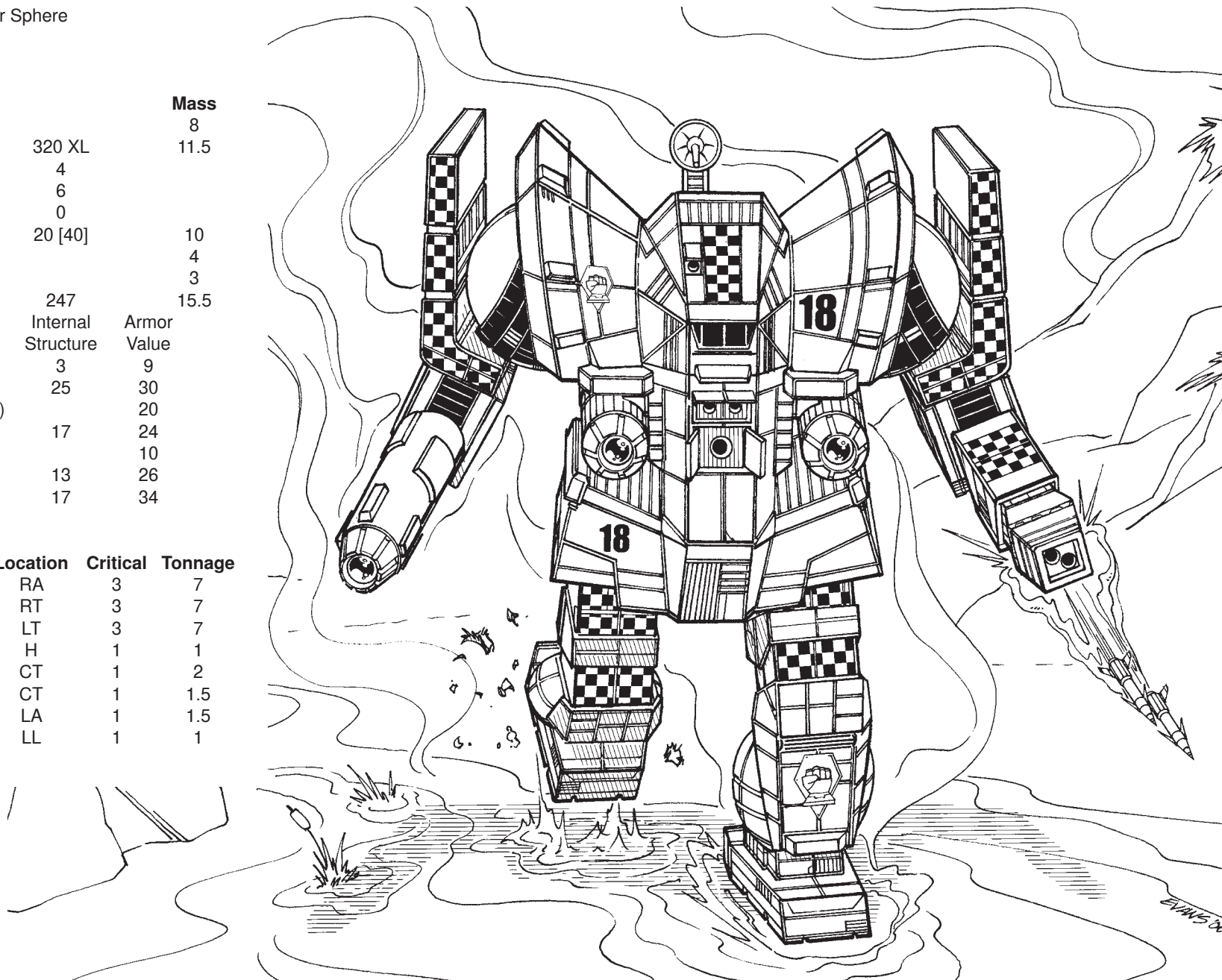

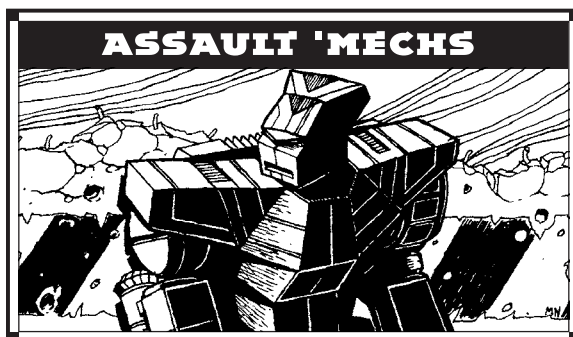

**Mass:** 80 tons

**Chassis:** Alshain Class 92

**Power Plant:** Hermes 400 XL

**Cruising Speed:** 54 kph

**Maximum Speed:** 86 kph

**Jump Jets:** Lexington Ltd. Lifters

**Jump Capacity:** 150 meters

**Armor:** New Samarkand Royal Ferro-Fibrous with CASE

**Armament:**

1 Shigunga Long Range Missile 20-Rack

4 Victory Heartbeat Medium Pulse Lasers

**Manufacturer:** Luthien Armor Works, Sapphire Metals

**Primary Factory:** Luthien (LAW, destroyed in 3069), Shimonita (Sapphire)

**Communications System:** Boran Meta-Cygnus Plus

**Targeting and Tracking System:** Delta Track with Artemis IV FCS

## Overview

Considered by many critics one of Luthien Armor Works' biggest failures in the assault BattleMech category, the *Charger* is a specialized 'Mech in the extreme. Often derided as a "light 'Mech trapped in an assault's frame," the *Charger* saw little use in the mainstream DCMS as a standard combat unit. Eventually, though, it became the saving grace of the Combine.

Under orders from the Coordinator, LAW desperately attempted to create a new BattleMech design that would be a symbol of the Dragon's might and strike fear into their opponents. LAW based its efforts on "re-directed" ComStar *Thugs* in the 3030s and seized an incredible opportunity presented by the flawed *Charger*.

LAW could readily field a large number of this "new" assault 'Mech by utilizing the *Charger's* chassis and assembly line. Thus, rather than starting anew, LAW cut manufacturing time in half by undertaking a massive modification program. This greatly accelerated the DCMS' reconstruction after the horrendous damage of the Fourth Succession War.

A side benefit from the crash *Hatamoto* program was the experience engineers gained with lost Star League technology. Rather than commit to converting all of their *Chargers* to newer *Hatamotos*, LAW saw an opportunity and proceeded to rework the CGR series with the rediscovered technology.

LAW unveiled a revamped *Charger* just as the Clan invasion hit the Periphery in 3049. The 'Mech utilized some of the more sophisticated systems the Combine had developed, including ferro-fibrous armor and pulse lasers. Encouraged by the DCMS' reception of these versions, several more variants were unveiled over the next fifteen years. Because it remained true to its revamped design—a close-in brawler—but packed more varied punch, the *Charger* was widely accepted by DCMS MechWarriors and finally became a common sight in many of the DCMS' premiere units. By 3068, every regular DCMS unit contained at least one of these post-3050 *Charger* variants.

Recently, the Sapphire Sunset yakuza clan on Shimonita bought and upgraded the system's small LAW complex (renamed Sapphire Metals) and began churning out CGR-3Ks, CGR-SA5s and the newer CGR-KMZ designs.

## Capabilities

Almost without exception, *Chargers* in any configuration are usually supplemented by heavier 'Mechs capable of keeping up with it. Because the weapon load-outs are usually lighter than other assault designs, *Charger* pilots tend to find themselves pairing up in combat in order to do more damage.

## Deployment

Though a smattering of *Chargers* can be found in any House military unit, these days the predominant user of *Chargers* still remains the DCMS. Most often, these units tend to deploy the more brutal SA5 version, which is known as an excellent urban fighter. The main

exception to this is the Ghost Regiments, where the newer KMZ variant has begun to find favor among the more aggressive yakuza members.

Large numbers of the 3K version still exist among many of the Combine's planetary militia and training cadres. No more are in production, however, thanks to the loss of LAW's Luthien plant.

## Variants

Perhaps the most common variant is the CGR-C, which trades out a medium pulse laser for a C<sup>3</sup> slave and an additional ton of LRM ammo.

The CGR-1L is seen mainly among CCAF training cadres. Rumor suggests that the 1L is also used as a punishment assignment to those whose views diverge from the State's.

Other variants exist but are much more rare. The original 1A1 is still seen among the backwater stables on Solaris VII, mainly as a labyrinth fighter. The 1A9 and 2A2 have been seen in some frequency in the Outworlds Alliance, though this is due more to LAW's legal snafu in allotting Raveena Electronics a production license.

Of interest is the new KMZ variant seen in use with the Tenth and Twelfth Ghost regiments. Paired light PPCs augment a torso-mounted heavy PPC while a multi-missile launcher provides extra punch. This "kamikaze" design also mounts heavier jump jets, giving it increased mobility along with heavier armor protection due to newer light ferro-fibrous armor weave. A stylized wakazashi mounted in the right hand rounds out this decidedly deadly design. Already other yakuza clans have begun opening negotiations with the Sapphire Sunset oyabun to acquire this upgraded variant.

## Notable MechWarriors

**Subcommander William Liao:** Subcommander Liao is from a Tikonov branch of the infamous family reduced to refugee status by the Fourth Succession War. His impoverished childhood during the Romano Chancellorship led him to continuously share his opinion of the ineffectual Confederation leadership ("We shouldn't have stopped at St. Ives, the Chesterton Commonality could've been ours!"), which in turn led to his current militia assignment in a CGR-1L.

# CGR-3K CHARGER

Type: **Charger**

Technology Base: Inner Sphere

Tonnage: 80

Battle Value: 1,656

## Equipment

Internal Structure:

Engine: 400 XL

Walking MP: 5

Running MP: 8

Jumping MP: 5

Heat Sinks: 12 [24]

Gyro: 4

Cockpit: 3

Armor Factor: 179

## Mass

8

26.5

*Internal  
Structure*

*Armor  
Value*

Head 3 9

Center Torso 25 27

Center Torso (rear) 7 7

R/L Torso 17 24

R/L Torso (rear) 7 7

R/L Arm 13 15

R/L Leg 17 22

## Weapons and Ammo

**Location Critical Tonnage**

LRM 20 RT 5 10

Ammo (LRM) 12 LT 2 2

CASE LT 1 .5

Artemis IV FCS RT 1 1

Medium Pulse Laser RT 1 2

Medium Pulse Laser RA 1 2

Medium Pulse Laser LT 1 2

Medium Pulse Laser LA 1 2

Jump Jet CT 1 1

Jump Jets LL 2 2

Jump Jets RL 2 2

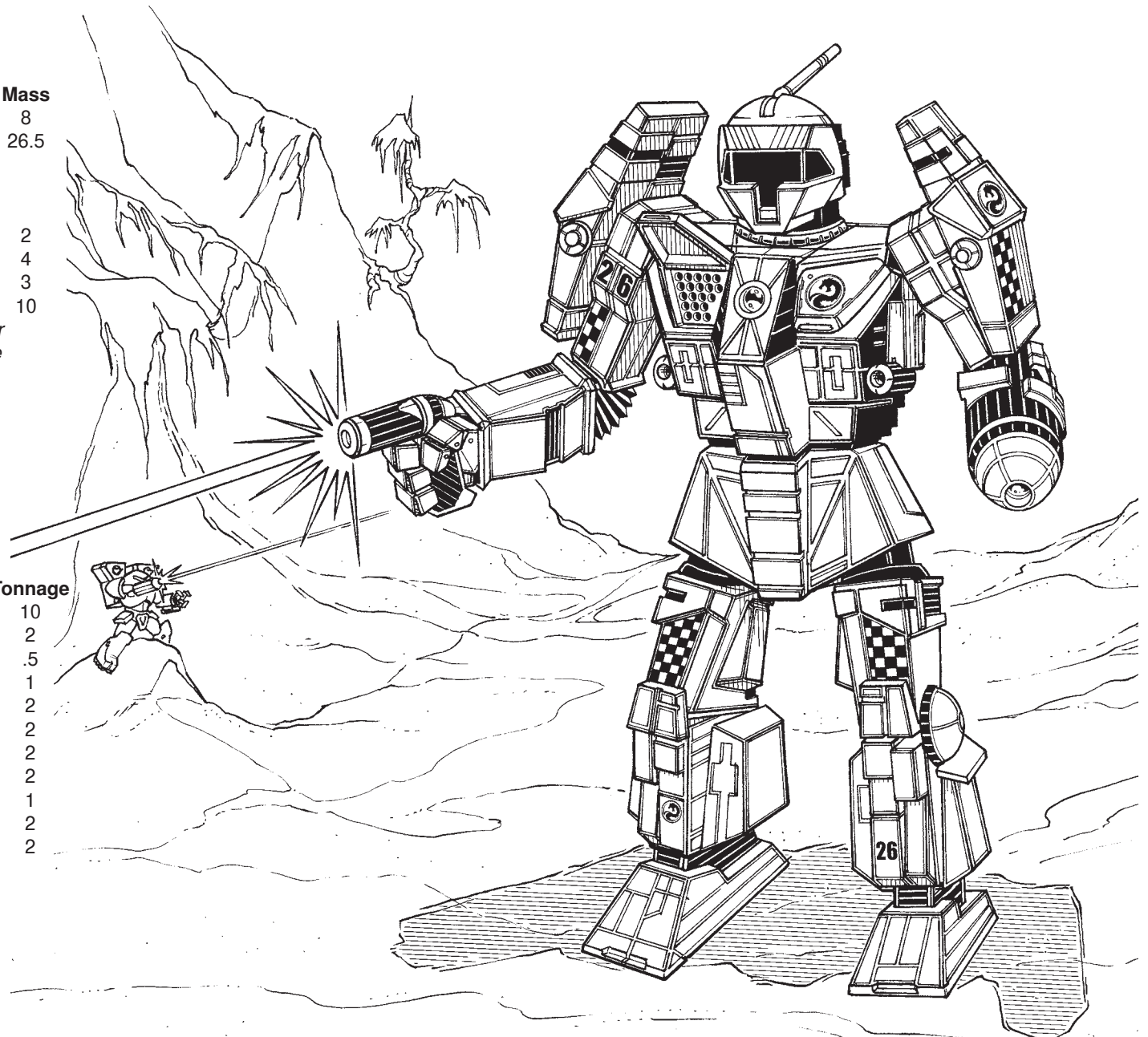

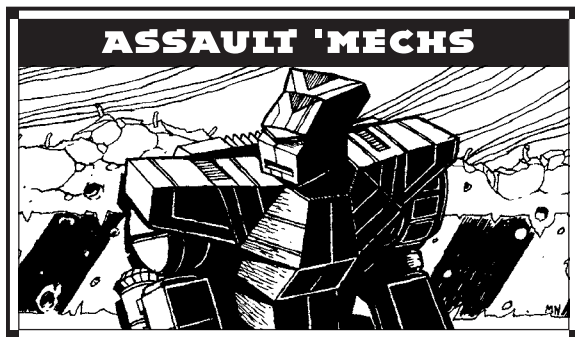

**Mass:** 80 tons  
**Chassis:** Earthwerks VOL Endo Steel  
**Power Plant:** Pitban 320  
**Cruising Speed:** 43 kph  
**Maximum Speed:** 64 kph  
**Jump Jets:** None  
**Jump Capacity:** None  
**Armor:** Mitchell Argon with CASE

**Armament:**  
2 Tiegart PPCs  
2 Bical-6 SRM 6s  
**Manufacturer:** Yori Mechworks,  
Independence Weaponry  
**Primary Factory:** Al Na'ir (Yori Mechworks),  
Quentin (Independence Weaponry)  
**Communications System:** Colmax 90  
**Targeting and Tracking System:** Garret D2j

## Overview

When Kanrei Theodore Kurita received ComStar support in the form of Star League era BattleMechs prior to the War of 3039, he was already looking ahead to see how he could turn his deal into a long-term advantage over the Federated Commonwealth. Several of these BattleMechs were secretly shipped to Luthien Armor Works and were carefully dissected in hopes of reverse engineering lost technology. Believing they could replicate the *Thug's* overall design—though unable to make an outright copy—LAW designers elected to base the *Hatamoto-Chi's* appearance and other key components on their *Charger* line on Luthien. To throw

MIIO off the trail, the design was released under the auspices of a “Maltex Corporation,” which resulted in an Acolyte’s data entry error in listing the primary factory as Errai when the BattleMech was finally released.

Though the engineers were able to duplicate many of the electronics, in order to produce the missing link (the highly advanced endo-steel chassis), LAW needed a zero-G manufacturing plant equipped for the task. Instead of building a brand new one, they traveled to the system of Al Na’ir, the location of a small facility that built BattleMech components until it was crippled in 3010. Repairing the facility in the early 3030s was obscenely expensive, especially reactivating the endo-steel mill. The *Hatamoto-Chi* had only been in production for over a decade before the climatic battle for Luthien during the Clan Invasion. With the premier facility right on the border, LAW decided to sell the design and the maintenance intensive facility to Yori Mechworks for the funds to upgrade their defenses and upgrade the rest of their production lines.

## Capabilities

Though attempting to replicate the *Thug*, the use of a *Charger* chassis often gives the impression of an original design. However, even being a crude duplication of a design produced centuries ago does not take away from the lethality of a pair of particle projection cannons backed up by a set of torso-mounted SRM-6s. The fifteen and a half tons of Mitchell Argon armor surrounding an endo-steel chassis with CASE enhanced ammo bins results in a nearly indestructible eighty-ton machine. The one drawback is the high heat curve of the *Hatamoto-Chi*. The Draconis Combine was unable to mass-produce the invaluable double heat sink technology until years after the design’s introduction.

## Deployment

The *Hatamoto-Chi* has become one of the standard issue low-end assault BattleMechs of the DCMS, with nearly every battalion that employs assault-class ‘Mechs containing at least one *Hatamoto-Chi* or its many variants. Many technicians find the once innovative arm and torso bays easy to repair or modify, and it takes the complete coring of the center torso to

permanently destroy one of these designs. Several times during the Draconis Incursion by rogue FedSun units, *Hatamoto-Chi* were destroyed on the field, only to appear less than a week later, rebuilt with no loss in capability.

## Variants

The *Charger* chassis’s spacious torso cavities and easily reconfigurable arm assemblies have understandably created a slew of accepted variants. Most of these centered around swapping out the pair of SRMs for other weapon systems such as medium lasers, LRMs, and even one version that carries an AC/5 while another mounts an extended-range large laser. As C<sup>3</sup> technology was accepted through the ranks, technicians began to strip those same torso bays of their weapons to mount a C<sup>3</sup> slave pod, and in some cases, master systems.

From the Quentin production lines, new variants have appeared utilizing even more cutting-edge technology. The 28T variant was a complete redesign, slowing it down but compensating with a set of jump jets. Seventeen double heat sinks keep its pair of extended-range PPCs cool. Backing up the main guns is a pair of ER medium lasers and Streak SRM-6s. Becoming a standard in DCMS design rather than an add-on, a C<sup>3</sup> slave resides in the torso.

## Notable MechWarriors

**Sho-sa Johann “Eddie” Haderer:** The child of a Free Worlds League merchant and a Kuritan Baroness, Johann Haderer was raised in the Combine during the tense days after the Fourth Succession War and strove to prove his loyalty by entering the DCMS. His family wealth allowed the purchase of a new *Jenner*, which he piloted ably for seven years before battlefield success during Operation Bird Dog led Theodore Kurita to award Haderer with a company command and a brand new HTM-27T *Hatamoto-Chi*. Subsequent successes against Clan Ghost Bear led to his transfer to the border with the Draconis March, where his experience was sorely needed in green units.



# HTM-27T HATAMOTO-CHI

Type: **Hatamoto-Chi**

Technology Base: Inner Sphere

Tonnage: 80

Battle Value: 1,607

## Equipment

Internal Structure:	Endo Steel	4
Engine:	320	22.5
Walking MP:	4	
Running MP:	6	
Jumping MP:	0	
Heat Sinks:	18	8
Gyro:		4
Cockpit:		3
Armor Factor:	247	15.5

	Internal Structure	Armor Value
Head	3	9
Center Torso	25	34
Center Torso (rear)		16
R/L Torso	17	25
R/L Torso (rear)		9
R/L Arm	13	26
R/L Leg	17	34

## Weapons and Ammo

	Location	Critical	Tonnage
PPC	RA	3	7
PPC	LA	3	7
SRM 6	RT	2	3
Ammo (SRM) 15	RT	1	1
CASE	RT	1	.5
SRM 6	LT	2	3
Ammo (SRM) 15	LT	1	1
CASE	LT	1	.5

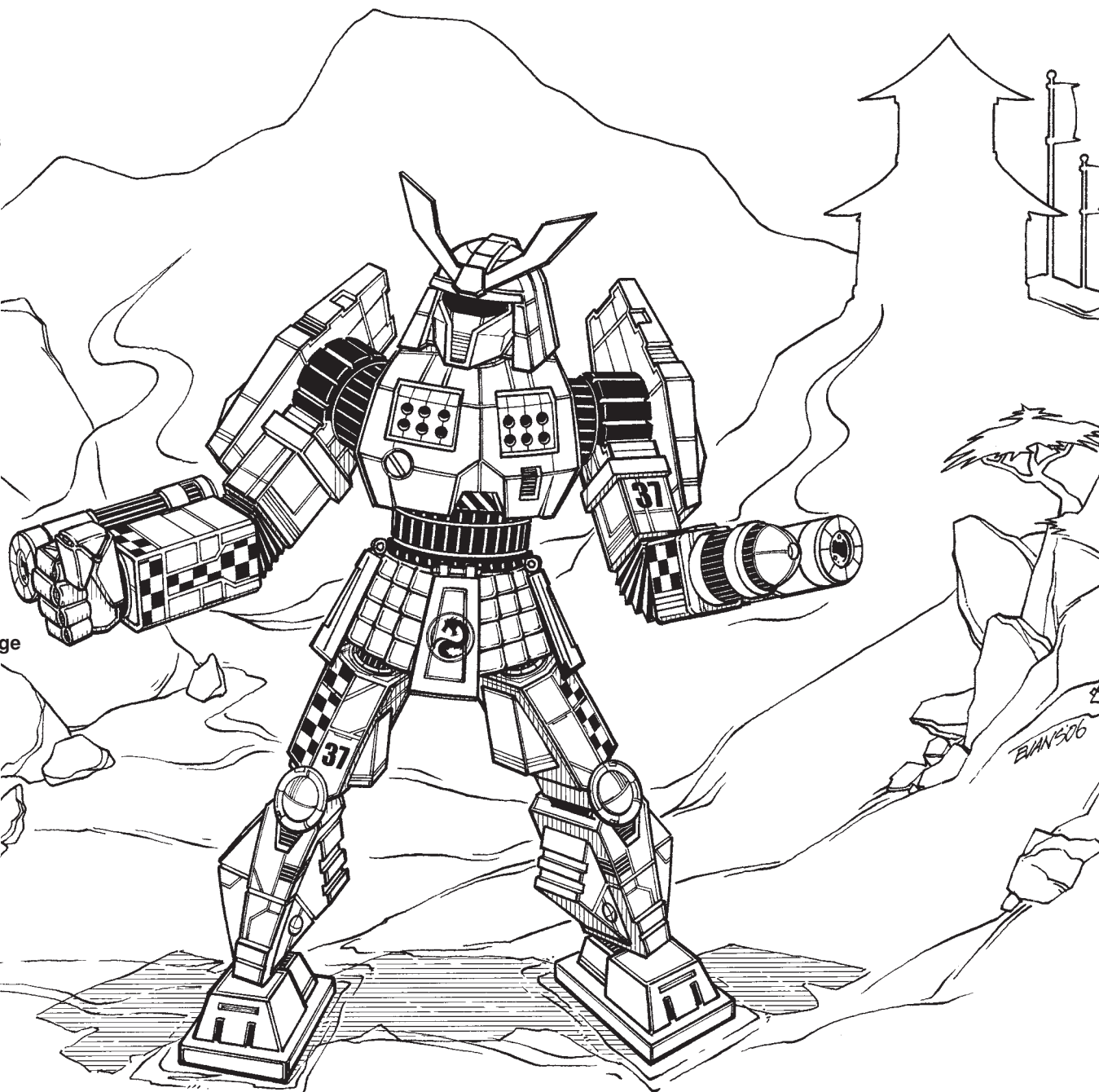

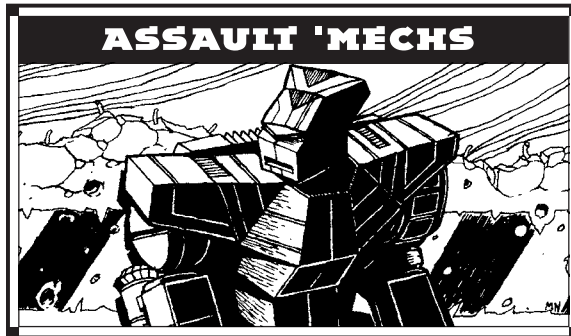

**Mass:** 80 tons

**Chassis:** Alshain Class 920 Endo Steel

**Power Plant:** Pitban 320

**Cruising Speed:** 43 kph

**Maximum Speed:** 64 kph

**Jump Jets:** Lexington Ltd. Lifters

**Jump Capacity:** 120 meters

**Armor:** Durallex Heavy with CASE

**Armament:**

- 1 Dragon's Fire Gauss Rifle
- 2 Victory Heartbeat Medium Pulse Lasers
- 1 Telos-4 SRM Launcher

**Manufacturer:** Independence Weaponry,  
HildCo Interplanetary, Tao Mechworks

**Primary Factory:** Quentin (Independence),  
St. Ives (HildCo), Styk (Tao)

**Communications System:** Sipher Security Plus

**Targeting and Tracking System:** Matabushi Sentinel

## Overview

Long a popular 'Mech in the AFFS, it was inevitable that priority would be given to upgrading the *Victor* with Star League technology. Independence Weaponry was almost into the prototype phase with their VTR-9D when Quentin fell to House Kurita during the War of '39. Redesigning the VTR-9K, the improved *Victor* entered mass production shortly after the Clans invaded the Inner Sphere.

The loss of its only *Victor* production line prompted the Federated Commonwealth to fund the reconstruction of Styk's Tao Mechworks to produce the VTR-9D and purchased output from the St. Ives Compact. While the components these factories use are sourced from

different manufactures, the end product is essentially identical to the VTR-9K.

Following the fall of St. Ives and the Styk Commonality to the Capellan Confederation, the Federated Suns turned to the General Motors/Blackwell factory on New Valencia to produce new *Victors*.

## Capabilities

The VTR-9K employs endo-steel internal structure to free up sufficient mass to upgrade its weapons array. The two medium lasers have been replaced with pulse models and a Gauss rifle replaces the powerful Pontiac autocannon. CASE protects not only the SRM magazine, but also the engine and gyro from damage resulting from a detonation of the Gauss rifle's capacitors.

The *Victor's* greatest asset remains the superb mobility it derives from powerful jump jets built into the legs and torso.

## Deployment

Always popular in the Davion Guards, the *Victor* regularly serves as a battalion or regimental command 'Mech. Following Katherine Steiner-Davion's assumption of the thrones of both the Lyran Alliance and Federated Commonwealth, the design officially fell from favor. During the FedCom Civil War, however, the *Victor* remained a firm favorite with Allied troops.

Though the capture of Independence Weaponry represented a major Combine victory, the warriors of the DCMS were unenthusiastic about piloting a design so closely identified with the hated House of Davion. The Ghost Regiments and Legion of Vega received the bulk of Independence's output. Following the reformation of the Star League and the defeat of Clan Smoke Jaguar, the design finally won acceptance from the warriors of the Combine.

The fall of St Ives and Styk have netted the Capellan Confederation two *Victor* manufacturing lines. These have been modified to also produce the new "Stealth" *Victor* for the CCAF.

## Variants

House Kurita has introduced a field upgrade kit to modify their VTR-9Ks to operate as part of a C<sup>3</sup>

network. The VTR-9C swaps out one heat sink to mount a C<sup>3</sup> slave.

Produced on New Valencia, the advanced VTR-10D also employs endo-steel construction. Armed with an Ultra AC/20, the CASE-protected magazine has a staggering thirty-round capacity. Streak technology has been added to the SRM-4 launcher and the pulse lasers have been swapped out for extended-range versions. The 10D mounts only twelve heat sinks, but these are double efficiency models.

The Capellan Confederation has started producing the VTR-10L on St. Ives and Styk. Mounting an ECM system and fifteen and a half tons of stealth armor, the design presents a foe with an elusive target at long range. It retains the Gauss rifle but adds an additional ton of ammunition. The SRM system is expanded into an SRM-6, and an additional medium laser has been added on the centerline. Like the arm lasers, this is an extended-range weapon.

Rushed into production on New Valencia during the Civil War, the VTR-11D utilizes a light engine and replaces the Gauss rifle with a RAC/5 and three tons of ammunition. The SRM launcher is upgraded to a Streak system, and two ER large lasers replace the pulse lasers. An additional two tons of armor protect the arms and legs, and a head-mounted C<sup>3</sup> slave allows the 11D to operate as part of a network. Fifteen double efficiency heat sinks are carried, and all ammunition is stored in a CASE-protected magazine in the right torso.

## Notable MechWarriors

**Captain Slater Donel:** A member of the Twelfth Vegan Ranger's Beta Regiment, Donel made a name for himself as a superb *Victor* pilot during the Capellan invasion of the Sarna March, and later in the FedCom Civil War.

Transferred to New Avalon to drive off the Word of Blake forces in 3068, Donel's skill in urban combat was instrumental in securing victory for the Rangers. Their triumph was short-lived, for the Blakists soon returned in greater numbers. Captain Donel and his company continue to hunt the invaders through the rubble-strewn streets of what was once the capital city of the Federated Suns.

Type: **Victor**

Technology Base: Inner Sphere

Tonnage: 80

Battle Value: 1,717

### Equipment

		<b>Mass</b>
Internal Structure:	Endo Steel	4
Engine:	320	22.5
Walking MP:	4	
Running MP:	6	
Jumping MP:	4	
Heat Sinks:	15	5
Gyro:		4
Cockpit:		3
Armor Factor:	200	12.5

	<i>Internal Structure</i>	<i>Armor Value</i>
Head	3	9
Center Torso	25	34
Center Torso (rear)		15
R/L Torso	17	23
R/L Torso (rear)		10
R/L Arm	13	18
R/L Leg	17	20

### Weapons and Ammo

	<b>Location</b>	<b>Critical</b>	<b>Tonnage</b>
Gauss Rifle	RA	7	15
Ammo (Gauss) 16	RT	2	2
CASE	RT	1	.5
2 Medium Pulse Lasers	LA	2	4
SRM 4	LT	1	2
Ammo (SRM) 25	LT	1	1
CASE	LT	1	.5
Jump Jets	CT	2	2
Jump Jet	RL	1	1
Jump Jet	LL	1	1

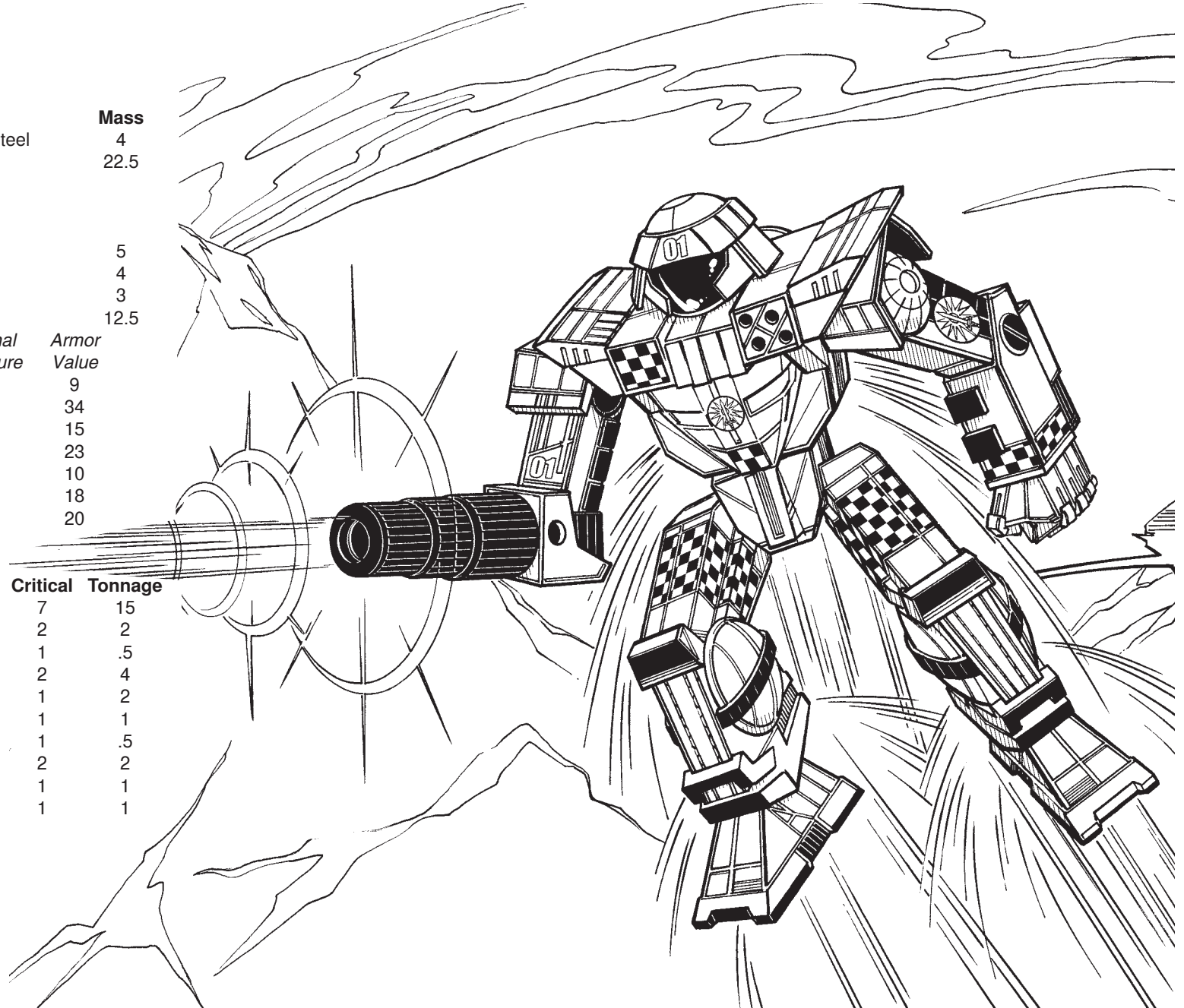

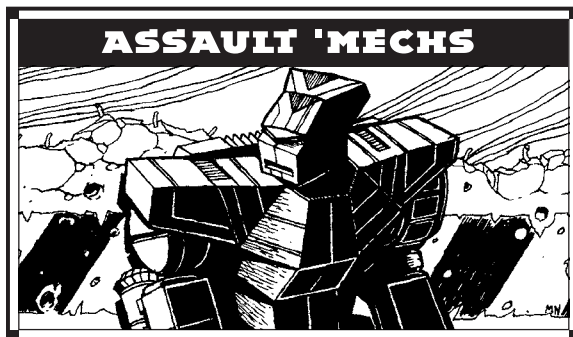

**Mass:** 80 tons

**Chassis:** Chariot Type III

**Power Plant:** Pitban 320

**Cruising Speed:** 43 kph

**Maximum Speed:** 64 kph

**Jump Jets:** None

**Jump Capacity:** None

**Armor:** Glasgow Limited Primo Ferro-Fibrous with CASE

**Armament:**

1 Defiance 1001 ER PPC

1 Cyclops XII Extended-Range Large Laser

2 Defiance P3M Medium Pulse Lasers

1 Coventry Starfire LRM-15 Missile Rack

**Manufacturer:** Defiance Industries

**Primary Factory:** Hesperus II

**Communications System:** TharHes Calliope ZE-2

**Targeting and Tracking System:** TharHes Ares-7

## Overview

A symbol of Lyran military strength and industrial might, the *Zeus* has been the pride of the Lyran military since it first walked off the Hesperan production lines in 2787, at the dawn of the First Succession War [EDITOR'S NOTE: prior publications have erroneously and inexplicably given this date as 2411, predating the first BattleMech, the *Mackie*]. For nearly three centuries, the *Zeus* has filled the ranks of the Lyran armed forces, its stature and heritage prized by officers and nobility across the Lyran Alliance even today.

## Capabilities

With good overland speed for an assault 'Mech, solid armor, and a diverse weapons array effective at

long and short-range alike, the *Zeus* is a dedicated brawler. The 9S model, which first debuted in 3048, sported recovered technology in spades: ferro-fibrous armor, CASE, pulse lasers, ER PPC and ER large laser, and double heat sinks. Though technically these innovations were mere upgrades to the existing equipment of the venerable ZEU-6S, they dramatically improved the *Zeus*' lethality and durability in combat.

## Deployment

As a Lyran signature 'Mech, the *Zeus* was slated by the FedCom military leadership for dispersal to all corners of the united Steiner-Davion realms, to further reinforce the symbolism of their alliance. While many *Zeuses* were so scattered, Davion pride tended to relegate many of the Steiner machines to rear-guard duty, or even export sale to mercenary employees. By the time hostilities erupted between the two halves of the sundered FedCom, most Lyran-made *Zeuses* in FedSuns formations were little more than curiosities.

## Variants

The original ZEU-6S, which sported standard armor, heat sinks, lasers, and a left arm Defiance autocannon/5, ended production soon after the debut of the improved 9S model. Also discontinued at the time was the 6T model, which swapped the autocannon for a Parti-Kill PPC. Ironically, the 6T was originally intended to be the base model for the *Zeus* but had been sidelined in the First Succession War due to technical issues with its PPC mount. The resolution of these issues by the end of the Third Succession War made it possible for the 6T to enter service and also served as the baseline for the 9S that would replace both Succession War variants.

In 3062, on the eve of the FedCom Civil War, the LAAF introduced the ZEU-9T *Zeus* as the first of the design class to carry a light fusion engine. The weight savings enabled Defiance engineers to add an extra ER medium laser to the design, enhance its LRM-15 rack with an Artemis fire control system, double the launcher ammo, and even increase the BattleMech's overall armor levels, resulting in a far deadlier machine than before. Fighting over the Hesperus II factories slowed the deployment of this variant during the

Civil War, however, as did the outbreak of the Word of Blake Jihad.

When the Word of Blake captured the Defiance factories in 3070, an experimental new model was reportedly underway that was to make use of recently developed technologies. Six months after the fall of the complex, according to local resistance, the experimental *Zeus*—dubbed the ZEU-10WB model by the Word—emerged on the practice field, sporting a heavy PPC in each arm, backed up by a quartet of ER medium lasers, an ER large laser, an extralight gyro, and a full fourteen tons of ferro-fibrous armor. The devastating new variant seems to have serious heat issues with this weapons load, however, indicating that its heat sink system was not overhauled to match the rest of the design.

## Notable MechWarriors

**Captain Stacy Church, Wolf's Dragons:** Stacy Church commands the first Wolf's Dragons unit to venture off of Arc-Royal since the Word of Blake all-but-annihilated the Dragons along with most of the rest of Outreach in December 3067. A long-serving Dragoon, Captain Church was picked to lead an independent company in 3069 after surviving Outreach. A former Trinary commander in the Wolf Spider Battalion, Stacy leads the reconstituted Black Widow Company. After the fighting on Outreach and then returning there to fight again two years later, she hates the Word of Blake with a passion that few can match.

Stacy's *Zeus*, a prototype *Zeus-X* model, is unique in the Inner Sphere. A former test-bed vehicle, the *Zeus* was given to the Dragons by the Kell Hounds when the Dragons arrived on Arc-Royal. Stacy modified it further, incorporating several experimental technologies, including the Blue Shield particle field damper, and the Actuator Enhancement System; the latter rumored to be a final piece of Blackwell technology. The powerful and distinctive *Zeus-X* is quickly becoming just as recognizable as Natasha Kerensky's old black *Warhammer*.

# ZEU-9S ZEUS

Type: **Zeus**

Technology Base: Inner Sphere

Tonnage: 80

Battle Value: 1,639

## Equipment

Internal Structure:

Engine: 320

Walking MP: 4

Running MP: 6

Jumping MP: 0

Heat Sinks: 17 [34]

Gyro: 4

Cockpit: 3

Armor Factor: 197

*Internal Structure*

## Mass

8

22.5

*Armor Value*

Head 3 9

Center Torso 25 26

Center Torso (rear) 8 8

R/L Torso 17 25

R/L Torso (rear) 6 6

R/L Arm 13 22

R/L Leg 17 24

## Weapons

### and Ammo

**Location Critical Tonnage**

ER PPC LA 3 7

ER Large Laser LT 2 5

LRM 15 RA 3 7

Ammo (LRM) 8 RT 1 1

CASE RT 1 .5

Medium Pulse Laser CT 1 2

Medium Pulse Laser LT (R) 1 2

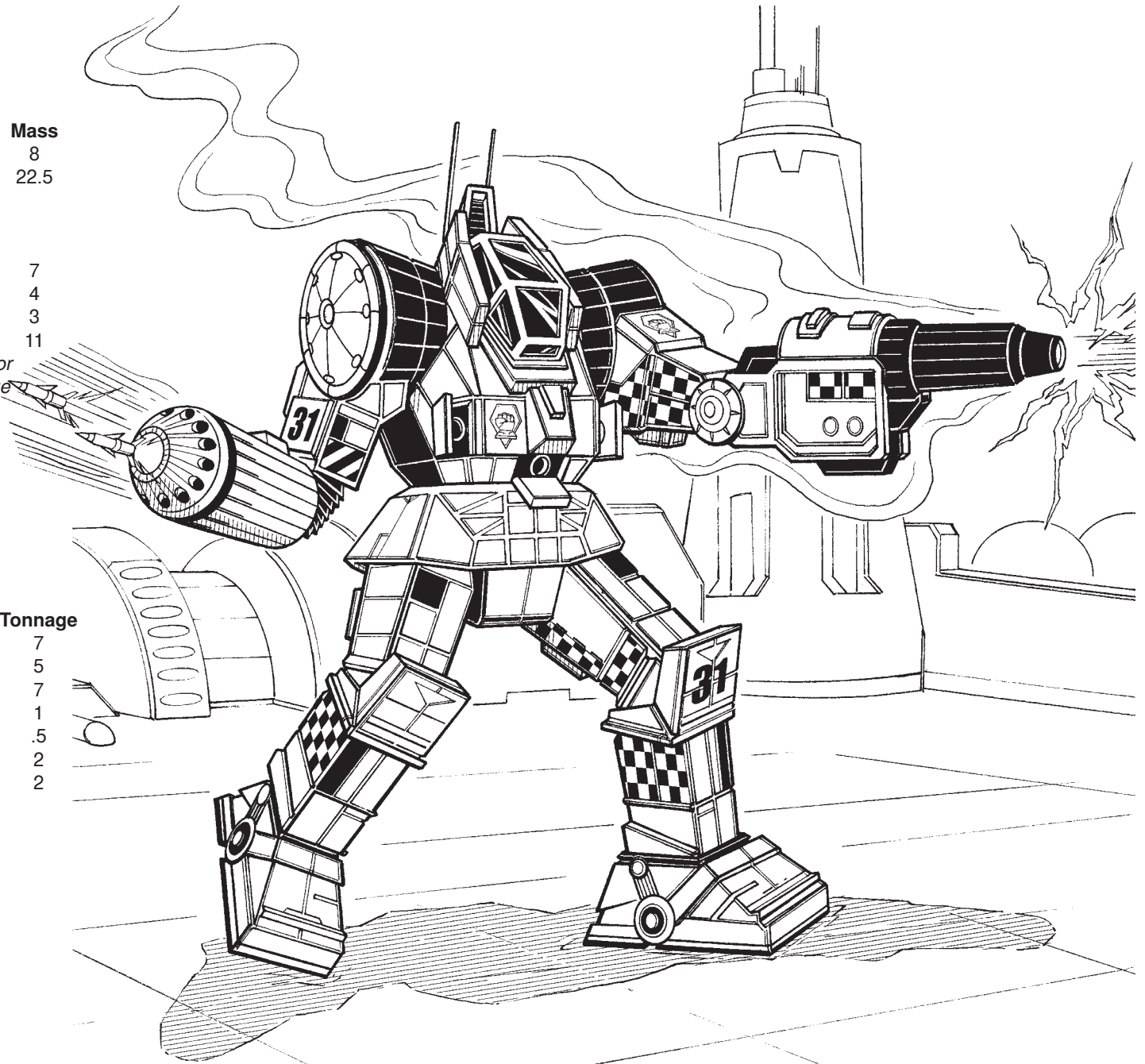

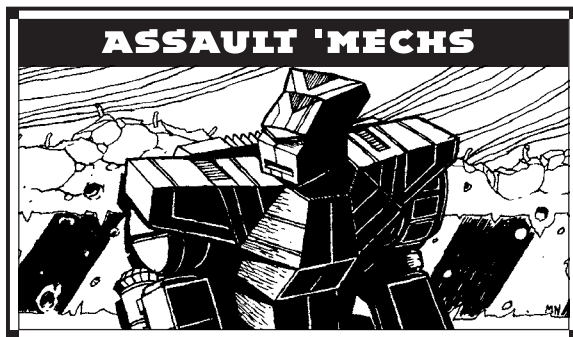

**Mass:** 85 tons

**Chassis:** Geometric 530 Hard Core

**Power Plant:** Strand 255

**Cruising Speed:** 32 kph

**Maximum Speed:** 54 kph

**Jump Jets:** Geotec 300

**Jump Capacity:** 90 meters

**Armor:** CarboStrand 30 Weight AS

**Armament:**

2 Magna Mk III Large Lasers

2 Holly-6 SRM Launchers

1 Blankenburg LB 10-X Autocannon

2 Dodd Small Lasers

**Manufacturer:** Blankenburg Technologies

**Primary Factory:** Soul, Terra

**Communications System:** GRPNTR Groundpainter 5

**Targeting and Tracking System:** Scope 30 RNDST

## Overview

One of the few Inner Sphere designs with two different names, the *Katana* is little different than its predecessor, the *Crockett*. In fact, both BattleMechs look identical. The reason for the dual nomenclature stems from the political and military changes occurring in the Combine during the 3030s rather than any design differences.

Originally developed as an assault 'Mech trainer (like the *Chameleon*), the *Crockett* ended up an even better war machine than a trainer. Because the design traded armor protection for jump jets and additional heat sinks, it ran cooler and had some additional mobility over other assault 'Mechs. The *Crockett* disappeared during the Succession Wars, the surviving machines secretly hoarded by ComStar.

In the 3030s, Primus Myndo Waterly approached the Combine, offering material desperately needed by the DCMS at no monetary cost, but only if then-Kanrei Theodore Kurita would help bring about and recognize the Free Rasalhague Republic. Though the fact that the DCMS received many stripped-down Star League-era BattleMechs from ComStar is known, only recently has it been discovered that there was more to the negotiations than previously believed. Before the Orestes Library was destroyed, DCMS archivists discovered several documents that show that as a gesture of good faith, Primus Waterly turned over the entire Blankenburg weapons storage facility on Soul to the Combine, including several Star League-built *Crocketts*. The Kanrei turned the warehouse over to Independence Weaponry, though still under the Blankenburg name for appearances. The engineers, after months of study, made some slight modifications to the newly found *Crocketts*, and renamed the "new" 'Mech the *Katana*. Speculation is that the Kanrei at the time forced the name change to deflect any in-depth scrutiny of the Combine's sudden rearmament.

Reverse-engineering the Star League weapons of the Soul facility allowed IW to construct a nearby factory complex to churn out advanced autocannon and laser weapons that were then sold to other Combine arms manufacturers. IW operated this factory under the ISF's watchful eye to guarantee these new weapons remained in the Combine.

Independence returned the Soul complex to Blankenburg Technologies' control at the end of their "lease" in 3064. Impressed with the new Independence *Katana* C<sup>3</sup> variants, Blankenburg hired the entire Independence *Katana* team, with IW's full approval—and a shared-technology agreement.

## Capabilities

Overqualified as an assault 'Mech trainer, the *Katana* is a very successful "light" assault 'Mech. The design quickly replaced *Chargers* among several Regulars and District troops, much to the pilots' delight. And when C<sup>3</sup> computer networks were green-lighted, IW quickly designed two *Katana* variants to exploit the new technology.

## Deployment

A mainstay of the DCMS' heavier mobile line units, the *Katana* is usually employed as a command element of a C<sup>3</sup> network. This allows the more flexible Omni units to concentrate their pod space on weaponry rather than bulky C<sup>3</sup> master systems.

## Variants

The two C<sup>3</sup> variants unveiled in the late 3050s remove a few lasers and SRM systems in order to make room for either a slave or master computer system.

In 3071, Blankenburg incorporated a heavy-duty gyro and improved jump jets on the CRK-5003-C frame, which contained a C<sup>3</sup> slave system. Boosting the design's jump profile to 150 meters, the newer CRK-5003-CJ replaced the large lasers with newly developed light PPCs and added two ER medium lasers. To handle the increased heat, the cooling system has been upgraded with double-strength heat sinks. So far, only the Galedon Regulars have received these new variants.

## Notable MechWarriors

**Chu-i Takiro Hutchison:** An average MechWarrior, Hutchison is not noted for his kill record, his mediocre grasp of tactics or even his devout loyalty to the Dragon and his commanding officers. Indeed, it was his defiance against *Tai-sa* Li Sak To that saved the lives of several Otomo on Luthien in 3068. Recognizing that the actions of his commander were wrong, Hutchison maneuvered his *Katana* in front of To's *Akuma*, preventing the Second Sword of Light commander from summarily executing several members of the elite unit. Refusing to allow such cold-blooded murder, he fought a savage duel against his commander, polarizing the Second Sword and buying enough time for the captured Otomo to escape to their BattleMechs. Though many of them were recaptured, including *Chu-sa* Franklin Sakamoto, the Otomo were able to sound the alarm and notify the First Genyosha of the attempted coup. The members of Hutchison's lance all carry small armor fragments of Hutchison's *Katana* to remind them of their duty to the Dragon.

# CRK-5003-2 KATANA (CROCKETT)

Type: **Katana (Crockett)**

Technology Base: Inner Sphere

Tonnage: 85

Battle Value: 1,629

## Equipment

Internal Structure:

Engine:

Walking MP:

Running MP:

Jumping MP:

Heat Sinks:

Gyro:

Cockpit:

Armor Factor:

## Mass

8.5

13

3

5

3

20

10

3

3

12.5

Internal  
Structure

Armor  
Value

Head

3

9

Center Torso

27

31

Center Torso (rear)

12

R/L Torso

18

23

R/L Torso (rear)

8

R/L Arm

14

19

R/L Leg

18

24

## Weapons

### and Ammo

Large Laser

Location

Critical

Tonnage

LA

2

5

Large Laser

RA

2

5

SRM 6

RT

2

3

SRM 6

LT

2

3

Ammo (SRM) 30

RT

2

2

LB 10-X AC

LT

6

11

Ammo (LB-X) 20

RT

2

2

Small Laser

RA

1

.5

Small Laser

LA

1

.5

Jump Jet

RL

1

1

Jump Jet

LL

1

1

Jump Jet

CT

1

1

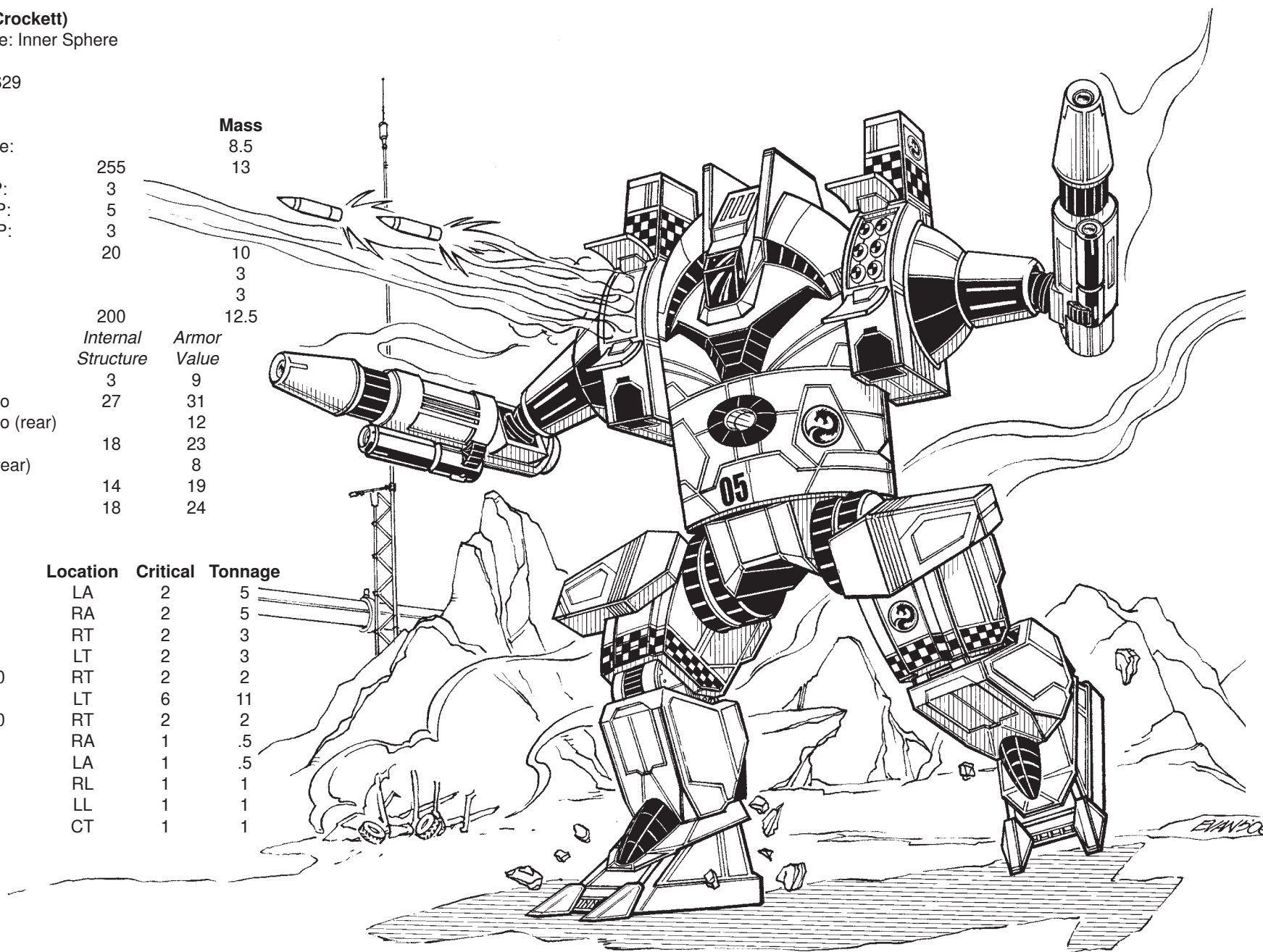

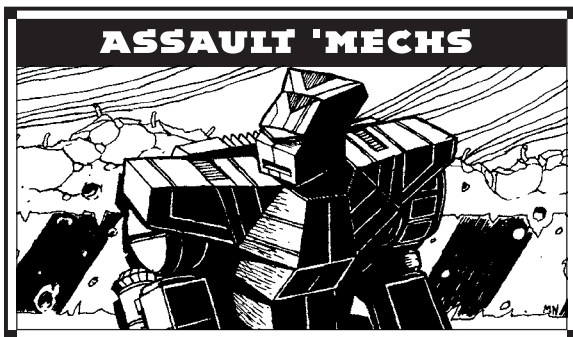

**Mass:** 85 tons

**Chassis:** Kitushi Shogun

**Power Plant:** Strand 255

**Cruising Speed:** 32 kph

**Maximum Speed:** 54 kph

**Jump Jets:** Anderson Propulsion 21

**Jump Capacity:** 90 meters

**Armor:** Riese-350

**Armament:**

1 Magna Firestar Extended-Range  
Particle Projection Cannon

2 Thunderstroke SRM-6 Racks

2 Coventry Star Fire LRM Missile Systems

**Manufacturer:** Mitchell Vehicles

**Primary Factory:** Graham IV (destroyed in  
First Succession War)

**Communications System:** HartfordCo COM 4000

**Targeting and Tracking System:** HartfordCo XKZ 1

## Overview

Rare even in its heyday during the Reunification War, the *Shogun* was thought lost to the Free Worlds League military after Kerensky's Exodus. When the Wolf's Dragoons arrived in the Inner Sphere at the beginning of the thirty-first century, Leaguers were shocked to discover that the mysterious mercenaries fielded several of the rare assault design in Zeta Battalion. Where they had found such ancient designs remained a closely held Dagoon secret.

Because the only factory capable of producing the design on Graham IV was destroyed during the early part of the First Succession War, no spare parts were

available for the custom-built Kitushi frame. Negotiations by Blackwell (on behalf of the Dragoons) with the government on Graham IV ended in repeated failure, all but guaranteeing the extinction of the design. By the late 3050s, reliable intelligence estimates put the number of operational *Shoguns*—all variants, including the rare Clan modification—at only six.

Though a capable BattleMech, one of the first League assault 'Mechs with a reliable jump jet system installed, the *Shogun* has faded from the modern battlefield. The Dagoon survivors evacuated from the system by Wolf (in-Exile) forces in 3068 managed to obtain some of the Dagoon's technological know-how, but not the engineering and design specifications of this particular BattleMech. With much of Outreach in radioactive ruins, it is doubtful any working models are in existence beyond two, both reported to be in the hands of Wannamaker's Widowmakers.

## Capabilities

Used frequently by fearless warriors of Wolf's Dagoon's Zeta Battalion, the *Shogun* was an effective urban assault BattleMech. Heavily reinforced legs and hips gave the 'Mech a solid weight that many Dagoon pilots used to their advantage executing the feared "Death From Above" maneuver.

Loaded with both long- and short-range missile racks, *Shoguns* often coordinated with infantry units moving through urban combat zones. The Dagoon infantry would routinely give fire orders to the more distant *Shoguns*, calling down missile hellstorms onto unsuspecting enemy units. During the confusion of the attack's aftermath, the *Shoguns* would then use their superior mobility to jump into short range and pummel their opponents before effective control could be regained.

Though these tactics were sound—and incredibly demoralizing to their opponents—the *Shogun* pilots would often take heavy damage in the exchange. With spare parts being scarce, the damage eventually took its toll. After the brutal losses on Misery, *Shoguns* became rare even among the rebuilt Dragoons and were reserved for more static fire and artillery lances.

## Deployment

During the Dagoon's pre-Clan years, *Shoguns* were found almost exclusively within Zeta Battalion. The few *Shoguns* found outside the famed mercenary unit were either hard-fought salvage or an extremely rare Free Worlds League family heirloom.

No *Shoguns* are known to exist in any standing army in the present day, except two salvaged from the remains of a Dagoon supply depot. These are reported to be in poor shape and undergoing decontamination by the Widowmakers.

## Variants

The original League design, designated the SHG-2E, used the same weapons loadout as the more common 2F, though with a standard Hellstar PPC system. Both versions were in common usage with the Dragoons during the Third and Fourth Succession Wars, though the exact specifications on the Magna Firestar ER version were a closely guarded Dagoon secret for decades.

## Notable MechWarriors

**Demi-Precentor Trisha Ryoko:** Head of salvage operations on Outreach, Precentor Ryoko is the Word of Blake liaison with Wannamaker's Widowmakers. Word from Outreach indicates that it was Ryoko who somehow managed to find one of the Dagoon's reserve bunkers on Remus. According to the same report, Ryoko has laid claim to one of the two *Shoguns* found there and has modified it during the clean-up operation. Our agent's report has this *Shogun* refitted with snub-nosed PPC and dual LB 5-X autocannons, which replace the damaged PPC and LRM racks, respectively. It is unknown if she plans on utilizing the 'Mech for her own personal ride or if it is to be shipped back to Terra and reverse engineered for mass production.

The MRBC has placed a "Wanted" notice on Precentor Ryoko, as she is believed to be the same Trisha Ryoko previously of the Tiger Sharks mercenary band. Reliable Wolfnet intelligence has pinpointed Ryoko as one of the chief planners of the Home Guard bombings, though the evidence is still circumstantial at best.



# SHG-2F SHOGUN

Type: **Shogun**

Technology Base: Inner Sphere

Tonnage: 85

Battle Value: 1,804

## Equipment

Internal Structure:		8.5
Engine:	255	13
Walking MP:	3	
Running MP:	5	
Jumping MP:	3	
Heat Sinks:	17	7
Gyro:		3
Cockpit:		3
Armor Factor:	248	15.5

	Internal Structure	Armor Value
Head	3	9
Center Torso	27	40
Center Torso (rear)		11
R/L Torso	18	28
R/L Torso (rear)		8
R/L Arm	14	22
R/L Leg	18	36

## Weapons and Ammo

	Location	Critical	Tonnage
SRM 6	RT	2	3
Ammo (SRM) 15	RT	1	1
CASE	RT	1	.5
SRM 6	LT	2	3
Ammo (SRM) 15	LT	1	1
CASE	LT	1	.5
LRM 15	RA	3	7
Ammo (LRM) 8	RT	1	1
LRM 15	LA	3	7
Ammo (LRM) 8	LT	1	1
ER PPC	RT	3	7
Jump Jet	LL	1	1
Jump Jet	RL	1	1
Jump Jet	CT	1	1

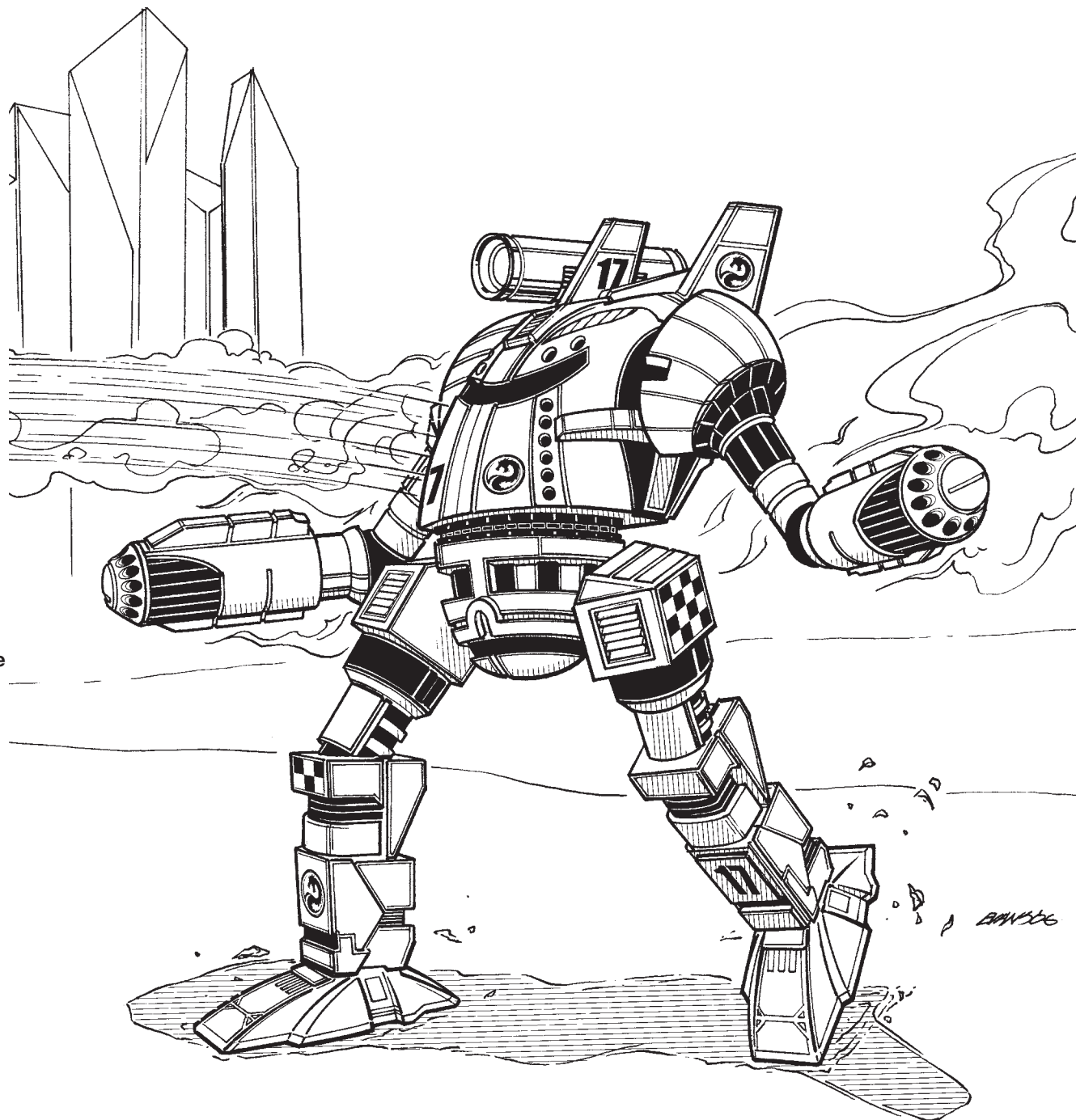

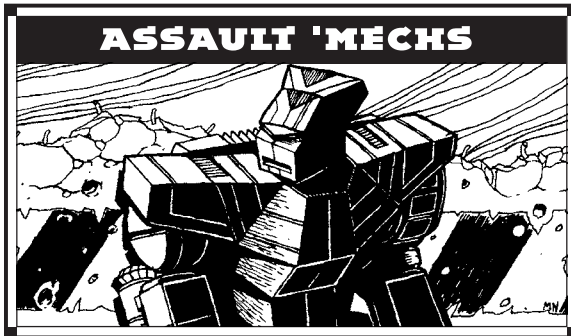

**Mass:** 85 tons

**Chassis:** Irian Chassis Class 30

**Power Plant:** Strand 255

**Cruising Speed:** 32 kph

**Maximum Speed:** 54 kph

**Jump Jets:** None

**Jump Capacity:** None

**Armor:** Riese-456

**Armament:**

- 1 Diverse Optics Sunbeam Extended-Range Large Laser
- 2 Irian Weapons Works LRM-10 Missile Racks
- 2 Irian Weapons Works SRM-6 Missile Racks
- 1 Octagon Missile-Magnet Narc Beacon
- 4 Magna Mk. II Medium Lasers

**Manufacturer:** Irian BattleMechs Unlimited

**Primary Factory:** Shiro III

**Communications System:** Irian E.A.R.

**Targeting and Tracking System:** Wasat Aggressor

## Overview

The *Stalker* has been in almost continuous production for nearly five centuries. Owing to that long and storied history, it is perhaps the most numerous assault-class BattleMech still serving the armies of the Successor States. It was little surprise, then, when Irian BattleMechs Unlimited began to upgrade its production line in the late 3040s.

## Capabilities

Like the stock *Stalker* that had long commanded the battlefields of the Succession Wars, House Marik's new version is designed around a layered offense,

mounting an arsenal capable of attacking enemies at all range profiles. It also utilizes double heat sinks that, while unable to handle all of the 'Mech's waste heat if its pilot fires most or all of the on-board weapons, make for an easier heat-management curve.

Paired LRM and SRM racks, backed up by two dual medium laser mounts, still make up the *Stalker*'s primary armament. Instead of the two standard large lasers, however, the Marik *Stalker* now carries a single ER version, using the mass saved by the second laser's deletion to mount a Narc missile beacon launcher with two tons of ammunition.

Irian's engineers added a ton of armor to the 'Mech, but even that unfortunately proved insufficient during the Clan Invasion. Having dismissed the value of CASE when compared to the additional armor, they failed to adequately solve the problem that had plagued the *Stalker* since its inception. During its baptism of fire on the Clan front, dozens of *Stalkers* and their pilots were vaporized in cascading ammunition explosions set off by critical heat levels and penetrating weapons strikes.

## Deployment

Every major military organization in the Inner Sphere and Periphery extensively utilizes the *Stalker* among their heavy and assault 'Mech formations, though the Free Worlds League and the two nations of the former FedCom field the great majority of upgraded versions. The *Stalker* has been involved in nearly every major battle those nations have fought since its reintroduction, from the Clan Invasion to the continuing battles for New Avalon.

## Variants

The FedCom introduced its first refit of the *Stalker* toward the end of the Clan Invasion, installing an XL engine to make room for pulse versions of the large lasers, an anti-missile system and CASE-protected torso ammunition magazines. The next variants did not appear until nearly a decade later, each native to one of the two FedCom nations. The Davion variant drops the LRMs, replaces the SRMs with Streaks, and ties a bevy of ER PPCs and lasers to an advanced targeting

computer. The Steiner variant instead mounts a light fusion engine and carries a heavy Gauss rifle in addition to paired ER PPCs, ER, and pulse lasers.

The final variant is Irian's attempt to make up for the shortcomings of the 5M. It drops the SRMs entirely, upgrades the LRMs to 15-tube racks with integral Artemis FCS, and upgrades the lasers to ER versions, mounting a fifth medium. Most importantly, they protected the LRM magazines with CASE, creating a truly survivable *Stalker*.

## Notable MechWarriors

**Captain Horace "Wandering Eye" Schulpius:** Captain Schulpius was a force commander with the First Free Worlds Guards during their invasion of Saiph in 3057. During the initial landing, a lucky shot from a defending FedCom Centurion's LB-X autocannon penetrated his torso's ammunition bin, detonating it. He was ejected clear of the doomed 'Mech, but not before receiving a neural shock that forever changed him. The once-reserved and calculating officer now barely—some say not at all—keeps rein on his sanity off the battlefield, but when behind the controls of his new *Stalker*, he loses all control, rushing headlong into the fray without regard for his own safety. Though he has somehow survived every battle since the accident unscathed—including battles during Operation Bulldog and the Great Refusal on Strana Mechty—Colonel Dana Briggs keeps him on a short leash in her command lance, letting him loose only when the time is right.

**Matsuoka Renya:** MechWarrior Matsuoka was one of the few ronin to survive Theodore Kurita's crackdown on the traditionalists that sided with Marcus Kurita in 3034. Escaping into the Periphery with his *Stalker*, he wandered from world to world, plying his trade to whomever could pay, especially those opposed to Theodore Kurita. The ISF tracked his movements to the Sarna March in 3049, where he disappeared. Many think that he has long since died, though some claim to have seen him leading Black Dragon Society gatherings in recent years, some even on Luthien itself.

# STK-5M STALKER

Type: **Stalker**

Technology Base: Inner Sphere

Tonnage: 85

Battle Value: 1,655

## Equipment

		Mass
Internal Structure:		8.5
Engine:	255	13
Walking MP:	3	
Running MP:	5	
Jumping MP:	0	
Heat Sinks:	17 [34]	7
Gyro:		3
Cockpit:		3
Armor Factor:	232	14.5

	Internal Structure	Armor Value
Head	3	9
Center Torso	27	36
Center Torso (rear)		11
R/L Torso	18	27
R/L Torso (rear)		9
R/L Arm	14	25
R/L Leg	18	27

## Weapons

And Ammo	Location	Critical	Tonnage
LRM 10	RA	2	5
Ammo (LRM) 24	RA	2	2
2 Medium Lasers	RA	2	2
LRM 10	LA	2	5
Ammo (LRM) 24	LA	2	2
2 Medium Lasers	LA	2	2
SRM 6	RT	2	3
Ammo (SRM) 15	RT	1	1
SRM 6	LT	2	3
Ammo (SRM) 15	LT	1	1
Narc Missile Beacon	LT	2	3
Ammo (Narc) 12	LT	2	2
ER Large Laser	CT	2	5

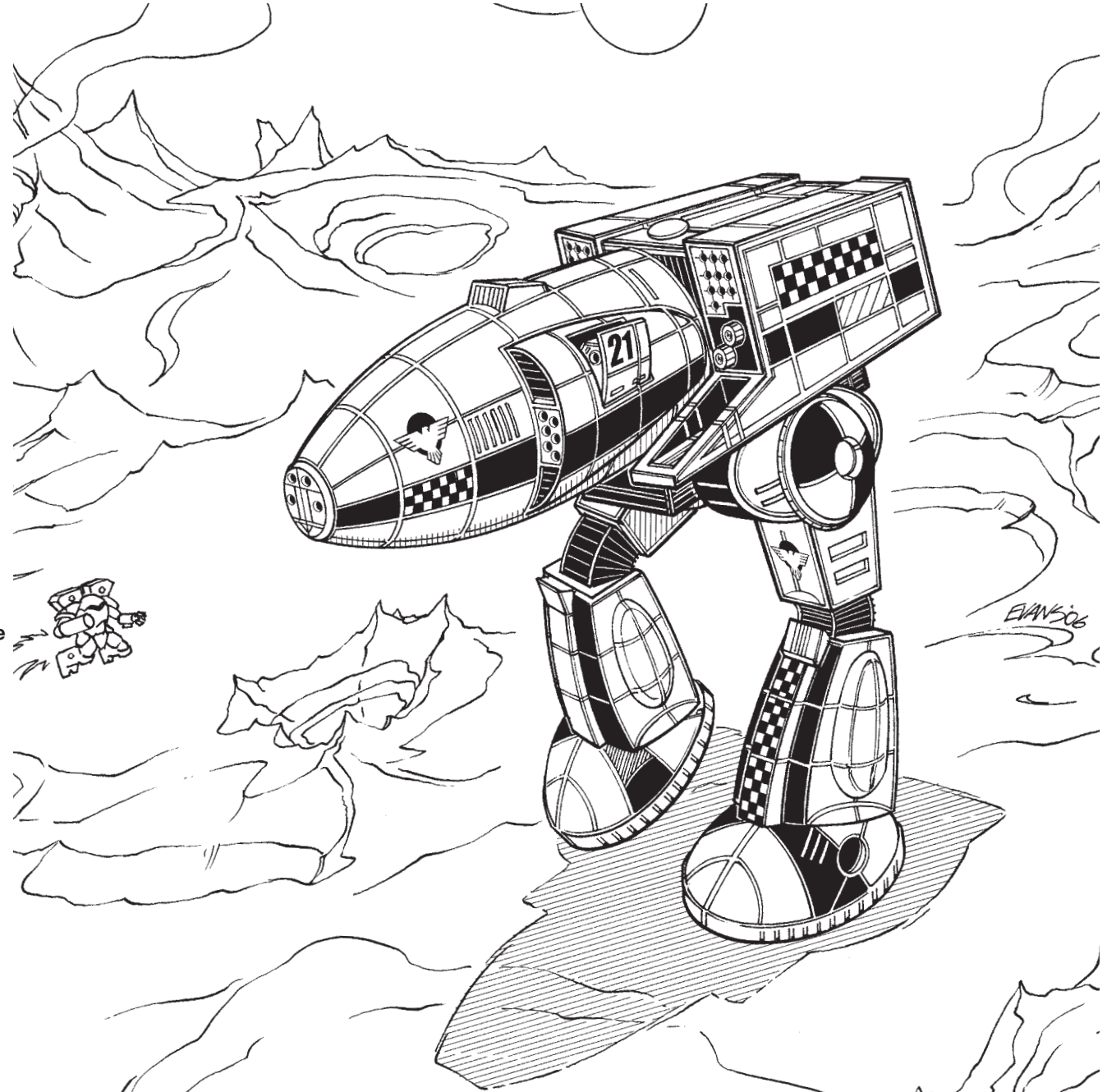

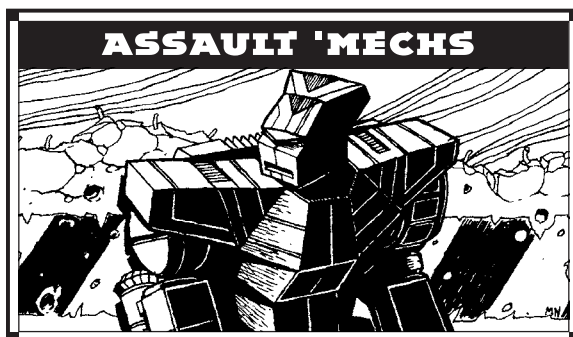

**Mass:** 90 tons

**Chassis:** Stormvanger HV-7

**Power Plant:** Hermes 360

**Cruising Speed:** 43 kph

**Maximum Speed:** 64 kph

**Jump Jets:** None

**Jump Capacity:** None

**Armor:** Starshield Special

**Armament:**

1 Zeus Slingshot Gauss Rifle

1 Delta Dart LRM 10

2 Diverse Optics Type 20 Medium Lasers

1 Hovertec Quad SRM 4

**Manufacturer:** Stormvanger Assemblies, Unlimited

**Primary Factory:** Caph (destroyed 2774)

**Communications System:** Olmstead 840

with SatNav Module

**Targeting and Tracking System:** Tacticon Tracer 280

## Overview

The *Cyclops* is a dedicated command 'Mech originally developed to serve in the SLDF's less prestigious line regiments and with the League's member states. Construction continued from 2710 until 2774, when Stormvanger's Caph assembly lines were destroyed by Rim Worlds Republic troops during the Amaris Coup. Lacking advanced technology reserved for the Terran Hegemony's Royal commands, the *Cyclops* survived throughout the Succession Wars. Attrition has reduced the number of operational 'Mechs, and many of the surviving examples have been modified for specific missions. The recovery of Star League technology has spawned a bewildering array of field upgrades.

## Capabilities

Powered by a massive Hermes 360 fusion engine, the *Cyclops* is fast for a ninety-ton assault 'Mech. This mobility comes at a price however, with armor protection limited to a barely acceptable ten tons of Starshield Special armor and weaponry more suited to a heavy BattleMech.

These shortcomings are more than offset by the *Cyclops*' Tacticon B-2000 battle computer. Capable of coordinating formations of up to brigade size, the computer makes the 'Mech highly prized by high-ranking officers.

With its rediscovery, the Gauss rifle is a common upgrade for any BattleMech armed with a heavy autocannon.

## Deployment

A *Cyclops* with an operational Tacticon B-2000 computer system is a highly prized item. All Inner Sphere militaries reserve the 'Mech to serve as a command vehicle for regimental and brigade-sized formations. In this role, the *Cyclops* is singled out by *Exterminators* and *Spectors* for headhunter attacks. Thus it is customary for a *Cyclops* to be escorted by a bodyguard lance.

Those *Cyclops* unfortunate enough to have lost their battle computers are relegated to service in assault formations. Unfortunately the 'Mech suffers disproportionately high casualties in these high-risk assignments.

## Variants

Another common field modification adds additional command and control equipment. The CP-11-C *Cyclops* replaces the Delta Dart LRM system with a C<sup>3</sup> master unit and adds two tons of armor.

Manufactured by Grumium Creations for the Com Guards, SLDF, and Free Rasalhague Republic, the CP-11-G *Cyclops* employs endo-steel and fifteen tons of ferro-fibrous armor. Its medium lasers have been upgraded to ER models, and the SRM launcher employs Streak technology. All ammunition is stored in the right torso in a CASE-protected magazine. One ton of LRM ammunition and a heat sink were removed, but the remaining eleven have been upgraded.

The CP-11-H was first sighted in the ranks "Lady Death" Trevaline's raiders. Replacing the missile launchers and all but two tons of autocannon ammunition with

six 20-tube rocket launchers, this bandit refit also boasts upgraded heat sinks. Armor is now ferro-fibrous, and an additional one and a half tons have been added.

Built on Grumium for the DCMS, the CP-12-K is similar to the 11-G. It also makes use of an endo-steel chassis, but only mounts thirteen and a half tons of standard armor. The LRM launcher is replaced with an MRM-20 and a ton of ammunition, and it carries an Ultra 10 in place of the Gauss rifle. The magazines in both torsos are CASE-protected. The twelve heat sinks have been upgraded, and the arm lasers have been updated to ER versions.

## Notable MechWarriors

**General Ariana Winston:** Daughter of Colonel Charles Winston of the Twenty-first Striker Regiment, Ariana grew up in the Eridani Light Horse. She quickly rose through the ranks, ultimately commanding the whole brigade. Chosen to participate in Operation Serpent, General Winston was selected by Marshal Morgan Hasek-Davion as his second in command for the mission to take the fight to the Clan Homeworlds. When the Marshal was assassinated, the responsibility for the mission fell to General Winston.

Leading a coalition force consisting of some of the Inner Sphere's best troops, Winston struck at Huntress, the seat of Clan Smoke Jaguar. Achieving complete surprise, Task Force Serpent overwhelmed the second line Jaguar defenders but then found themselves in a fight to the death with the remnants of the Jaguar's frontline troops forced to flee the Inner Sphere.

General Winston fell in battle leading her troops from the cockpit of her *Cyclops* just before a relief force arrived from the Inner Sphere.

**Colonel Janice Annapolis:** Shepherding her Periphery Star Guard from her ancient BattleMech—upgraded to CP-11-A specification—Colonel Annapolis recently led her Guard into heavy combat against League troops. Why Marik forces would be striking at the world of Loburg, so far from their current war, is unknown. Though the StarCorps plant on Loburg is a prime target, striking at a facility of a company that sells liberally to the League, seems dangerous in the extreme.

# CP-11-A CYCLOPS

Type: **Cyclops**

Technology Base: Inner Sphere

Tonnage: 90

Battle Value: 1,547

## Equipment

Internal Structure:		9
Engine:	360	33
Walking MP:	4	
Running MP:	6	
Jumping MP:	0	
Heat Sinks:	12	2
Gyro:		4
Cockpit:		3
Armor Factor:	160	10

	Internal Structure	Armor Value
Head	3	9
Center Torso	29	30
Center Torso (rear)		11
R/L Torso	19	20
R/L Torso (rear)		8
R/L Arm	15	10
R/L Leg	19	17

## Weapons and Ammo

	Location	Critical	Tonnage
Gauss Rifle	RT	7	15
Ammo (Gauss) 16	RT	2	2
LRM 10	LT	2	5
Ammo (LRM) 24	LT	2	2
SRM 4	CT	1	2
Ammo (SRM) 25	CT	1	1
Medium Laser	RA	1	1
Medium Laser	LA	1	1

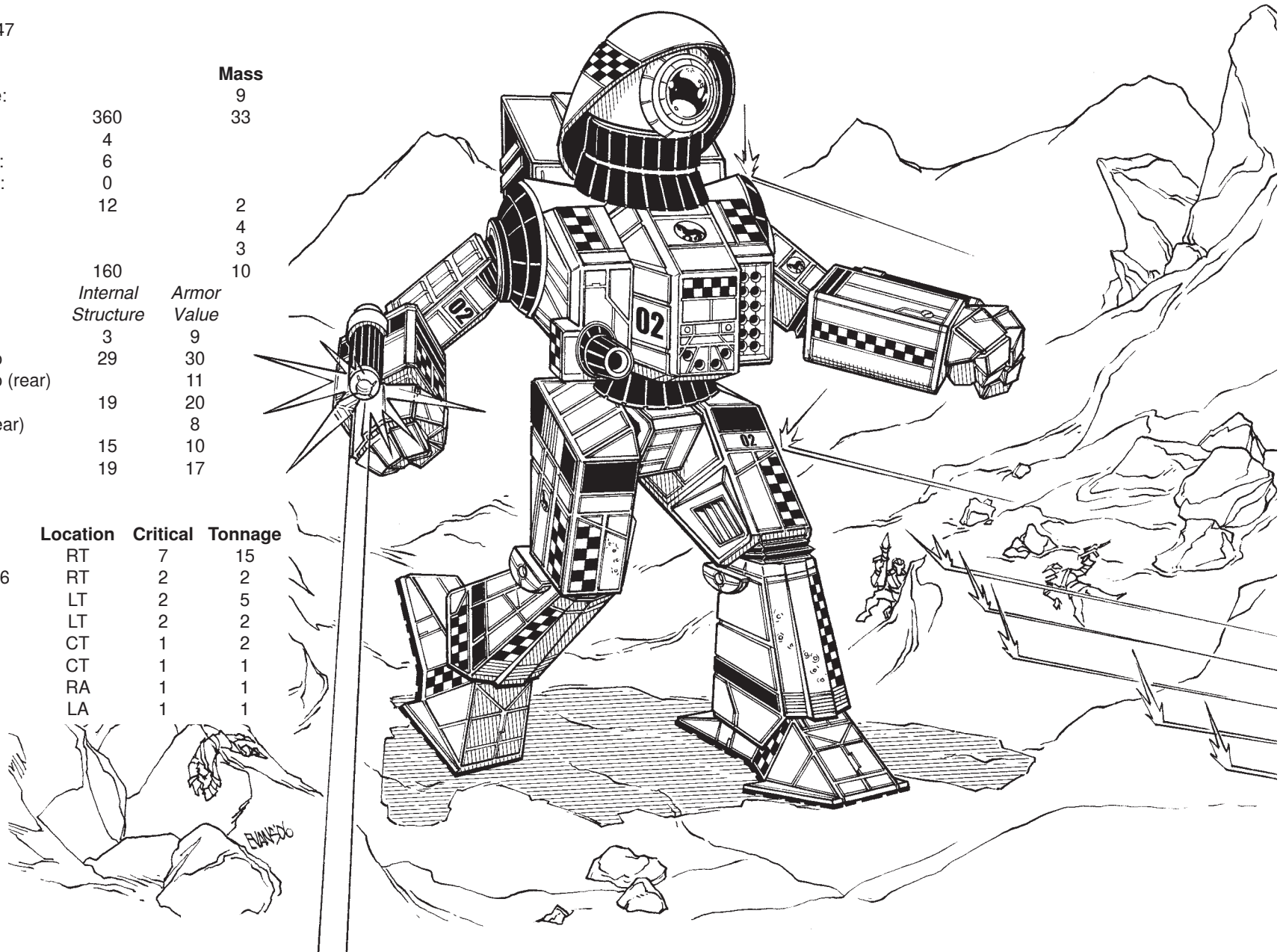

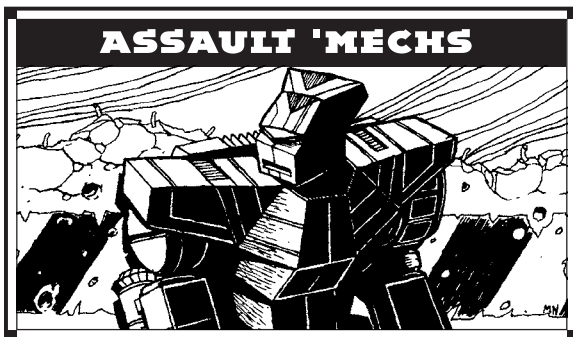

**Mass:** 90 tons

**Chassis:** Alshain Class 101

**Power Plant:** Hermes 270 XL

**Cruising Speed:** 32 kph

**Maximum Speed:** 54 kph

**Jump Jets:** None

**Jump Capacity:** None

**Armor:** New Samarkand Royal Ferro-Fibrous  
with CASE

**Armament:**

2 Victory Nickel Alloy Extended-Range  
Large Lasers

2 Shigunga Long Range Missile 15-Racks

4 Imperator Smoothie-2 Autocannon

**Manufacturer:** Luthien Armor Works

**Primary Factory:** New Samarkand

**Communications System:** Sipher Security Plus mk.II

**Targeting and Tracking System:** Matabushi  
SuperSentinel

## Overview

In 3036, Luthien Armor Works participated in Project *Daboku*, along with several senior-ranking officers of the DCMS High Command, Independence Weaponry, and Wakazashi Enterprises. Originally a think tank project, this small group of researchers and career officers was tasked by the Coordinator to examine the Star League technology gained in the Helm Memory Core as well as what equipment had been given to the Dragon by ComStar.

Project *Daboku* was a mediocre success at best. Doomed from the start due to the highly charged political mix of hard-liners, corporate fast trackers, and

eccentric scientists, the best result from the short-lived think tank was the designs for the *Daboku*. Conceived as an assault-class BattleMech with similar characteristics to IBMU's *Awesome* design, the project was shoved into LAW's hands and conveniently forgotten.

The *Daboku* debuted to little fanfare in 3038 and almost immediately earned the disdain of every MechWarrior that piloted it. Only three hundred were made before the design was halted after several combat reports came back describing in excruciating detail the various flaws of the machine. The *Daboku* was shelved as a failure.

According to the detailed reports, the *Daboku*'s chest frame arrangement somehow interfered with part of the CASE system meant to protect the pilot. If the center part of the torso was hit hard enough, sensors sometimes read the resultant damage as a pilot-threatening ammo explosion, firing the auto-eject sequence even when the system was disengaged.

To the amusement of many in the DCMS Quartermaster department, the nascent AFFC snapped up the pristine salvage during 3040s border skirmishes and deployed them among Lyran units scattered on the Periphery border. Combine warriors were instructed that the quickest way to kill an AFFC *Daboku* was to target the lower center plate of armor, near the thighs.

## Capabilities

The *Daboku* received a second look when Victory Armaments perfected their extended-range lasers in late 3046. Looking for an easy platform to mount them on, a LAW technician came across the specifications for the *Daboku*. The *Daboku* was a test-bed for the ER lasers, new heat sink technology and an extra-light engine. Finding the required chassis modifications to be minimal, LAW approved the design and rushed it into production.

A chance conversation between an ISF case officer and LAW's DCMS liaison produced the Davion codename of "*Mauler*" for the original *Daboku* series. LAW officials decided to change the name due to the poor reputation the failed design had gained so quickly; lacking any original ideas, they used the fearsome Davion moniker. The first of the new *Mauler* series headed to the Suns border in 3048.

Unfortunately, one of the *Daboku*'s original design flaws was accidentally ignored in the initial production runs. The safety system flaw of the *Daboku* was overlooked in the *Mauler* and was not corrected until 3051.

## Deployment

Produced in massive quantities during the years of the Clan Invasion and again during Operation Bulldog, *Maulers* can be found in almost every DCMS unit still in service. Additionally, thanks to battlefield salvage, they can also be found among several AFFS and LAAF units as well.

As of this report, none of the original *Daboku* models still exist with any active military command.

## Variants

The original *Daboku* design mounted dual LRM 10 launchers in addition to paired large lasers and four Smoothie-2s. Using only standard armor plating, it would not last long against other assault-class 'Mechs, however.

Two C<sup>3</sup> variants exist, though one is only a slight upgrade from the 1R design. The other utilizes paired LB-10X autocannons at the expense of its large lasers and small-bore autocannons.

LAW/New Samarkand rolled out a newer variant of the *Mauler* on its lone assault-Mech line. This design utilizes paired snub-nosed PPCs along with four light autocannon/5s. How the Combine came into possession of this new technology is still up for debate. With the lighter weapons load, LAW designers increased the armor capacity of the 'Mech, making it a fearsome—if overheated—weapon for the DCMS.

## Notable MechWarriors

**Chu-i Marissa Frestadt:** Youngest daughter of Jeroen Frestadt, a convicted traitor of the Combine, Marissa managed to enlist with the Pesht Regulars under an assumed name. When approached by an ISF officer six months later, she agreed to undergo intense background checks and surveillance for over seven years just to prove that she was not her father's daughter. The ISF cleared Marissa's name from the "gray list" in 3068 and she was immediately promoted to lance commander within the Seventh Pesht Regulars.

# MAL-1R MAULER

Type: **Mauler**

Technology Base: Inner Sphere

Tonnage: 90

Battle Value: 1,460

## Equipment

Internal Structure:

Engine:

Walking MP:

Running MP:

Jumping MP:

Heat Sinks:

Gyro:

Cockpit:

Armor Factor:

		Mass
		9
270 XL		7.5
3		
5		
0		
11 [22]		1
		3
		3
206		11.5

	Internal Structure	Armor Value
--	--------------------	-------------

Head	3	9
Center Torso	29	27
Center Torso (rear)		10
R/L Torso	19	26
R/L Torso (rear)		10
R/L Arm	15	22
R/L Leg	19	22

## Weapons and Ammo

	Location	Critical	Tonnage
ER Large Laser	RA	2	5
ER Large Laser	LA	2	5
LRM 15	RT	3	7
Ammo (LRM) 16	RT	2	2
CASE	RT	1	.5
LRM 15	LT	3	7
Ammo (LRM) 16	LT	2	2
CASE	LT	1	.5
2 AC/2	RT	2	12
Ammo (AC) 45	RT	1	1
2 AC/2	LT	2	12
Ammo (AC) 45	LT	1	1

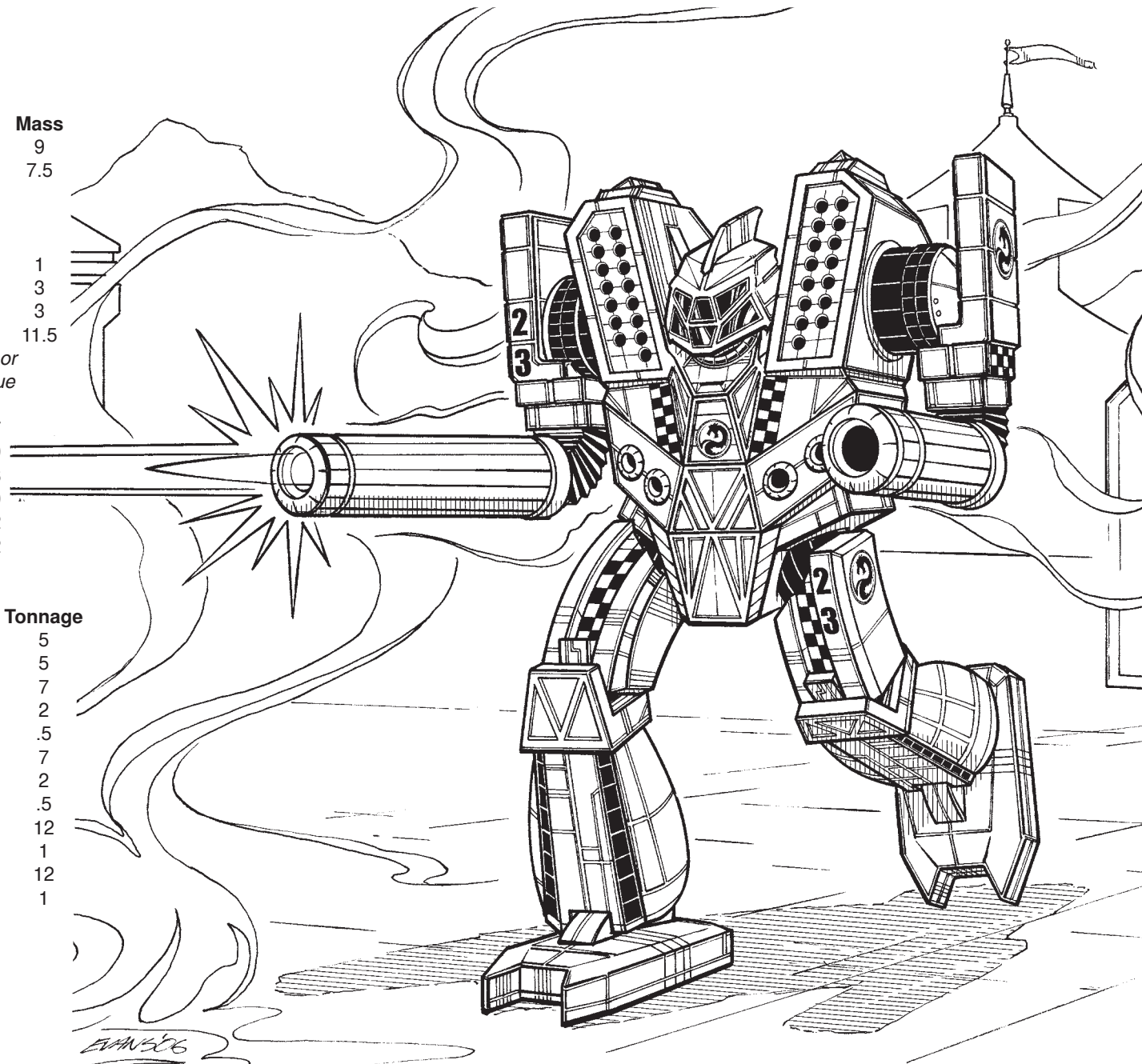

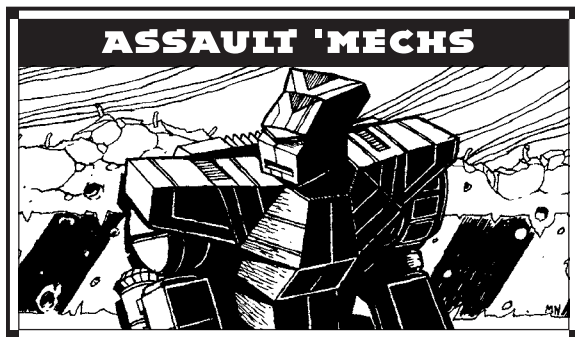

**Mass:** 95 tons

**Chassis:** Foundation 210

**Power Plant:** Edasich Motors 380 XL

**Cruising Speed:** 43 kph

**Maximum Speed:** 64 kph

**Jump Jets:** None

**Jump Capacity:** None

**Armor:** Longanecker PlastiSteel

**Armament:**

- 1 Poland Main Model A Gauss Cannon
- 2 Defiance 1001 Particle Projection Cannon
- 1 TharHes Maxi SRM-6 Rack
- 4 Defiance B3M Medium Lasers
- 2 Defiance B3S Small Lasers

**Manufacturer:** Defiance Industries

**Primary Factory:** Hesperus II

**Communications System:** Angst Clear Channel 3

**Targeting and Tracking System:** Angst Clear View 2A

## Overview

The *Banshee* has one of the most storied histories in the Inner Sphere. One of the first assault 'Mechs, it was criticized for being severely under-armed for its tonnage and intended application (close assault), and thus of dubious value even before production began. The production contract was also questionable: five thousand *Banshees* were built in just a decade, despite poor showings in field trials. While the THAF might have been stuck with purchasing the *Banshee*, it did not make frontline units suffer and relegated the 'Mech to militias and second-line units before production was complete.

And despite this inauspicious beginning, large numbers of *Banshees* survived the bloodiest half-mil-

lennium in human history, perhaps because they remained in backwater duty stations. Lyrans were the first to see the potential of the huge machine. They decided to utilize the large amount of *Banshees* remaining in the LCAF (later even opening a production line on Hesperus II). By reducing the engine size, they were able to outfit 'Mech with an impressive array of weaponry. The *Atlas* now had a challenger for the title of King of the Battlefield.

This renaissance of the *Banshee* was well timed. Lost technology was put to good use on the newly popular *Banshee*, though unlike other designs, Defiance has continued to tinker with the *Banshee*, pacing technological advances. Even the Word of Blake has continued this approach; since their capture of Hesperus II in 3070, another variant of the 'Mech has been spotted in the Hesperus II garrison. [EDITOR'S NOTE: One of the most egregious errors of the original ComStar *Technical Readout: 3050* document—an error my team and I, I'm forced to admit, perpetuated in our revision—was the inclusion of the wrong BattleROM image for the BNC-5S; it appears to have been an image of the BNC-3S. This is particularly puzzling as the dossier contained the correct battlefield characteristics for the 5S. Nevertheless, this has caused endless confusion over the years. Confusion I hope this upgrade document will finally alleviate.]

## Capabilities

The BNC-5S relies upon an immense amount of long-range firepower. Dual extended-range PPCs and a Gauss rifle match most assaults, but the addition of a SRM-6 rack and pairs of medium and small lasers give even more firepower. A pair of rear-firing medium lasers serve as a deterrent to attacks from behind. With a top speed of over 60 kph, the *Banshee* is capable of keeping up with all but the fastest assault and heavy 'Mechs. The *Banshee*'s greatest limitations are its heat dissipation abilities and its armor. While fifteen tons of Longanecker PlastiSteel is enough for most 'Mechs, this is considered light for an assault 'Mech; especially with a vulnerable XL engine.

## Deployment

The *Banshee* can be found in almost every army in the Inner Sphere and Periphery in one form or another.

The great majority of *Banshees* are found in the Lyran Alliance, some with AFFS units and mercenaries that have long worked with the Lyrans, though the newest variant is filling out WoB militia units. The older 3S is more frequently found in militia units and on non-Clan Periphery borders.

## Variants

With Defiance's constant tinkering, there are currently four versions of the *Banshee* employing modern technology. The 6S uses a light engine and, like the 3E, has only three weapons, the ubiquitous small laser, an LB 10-X autocannon and a heavy Gauss rifle. The 7S is similar to the 5S but drops a PPC to use the less vulnerable light engine and add armor.

A variant produced by Defiance after its capture by the WoB, and perhaps the most radical, is the 8S. It retains the XL engine but mounts a snub nosed PPC, extended-range large laser, LB 10-X autocannon, a C<sup>3</sup> slave and an ECM unit. An assortment of standard and ER medium and small lasers provide short-range firepower. Most striking, however, is the axe and triple-strength myomers. Thirteen double heat sinks allow it to quickly heat up to take advantage of the myomers, and eighteen tons of armor grant substantial protection.

## Notable MechWarriors

**Captain John Bauer:** A company commander in the Third Royal Guards, John frequently freelances with his company, a trait that would have cost him his commission if it weren't for his success. He prefers to move quickly and hit opponents at long-range with his precise aim. Once the enemy is aware of his presence, he's not afraid to get close and use his 'Mech's devastating physical attacks.

**Trent "Bullfrog" Sawyer:** While the speed of the *Banshee* will catch few off guard these days, Bullfrog Sawyer always surprises his opponents. As a MechWarrior for Bronson's Horde, he has removed one of his PPCs and a heat sink to install jump jets on his *Banshee*. Bullfrog likes to get into combat with an opponent and wait for an opportunity to jump directly in back of them and try to punch through the rear armor.



# BNC-5S BANSHEE

Type: **Banshee**

Technology Base: Inner Sphere

Tonnage: 95

Battle Value: 2,065

## Equipment

		Mass
Internal Structure:		9.5
Engine:	380 XL	20.5
Walking MP:	4	
Running MP:	6	
Jumping MP:	0	
Heat Sinks:	14 [28]	4
Gyro:		4
Cockpit:		3
Armor Factor:	240	15

	Internal Structure	Armor Value
Head	3	9
Center Torso	30	40
Center Torso (rear)		17
R/L Torso	20	30
R/L Torso (rear)		10
R/L Arm	16	21
R/L Leg	20	26

## Weapons and Ammo

	Location	Critical	Tonnage
Gauss Rifle	LT	7	15
Ammo (Gauss) 8	LT	1	1
2 ER PPC	RT	6	14
SRM 6	RA	2	3
Ammo (SRM) 15	RA	1	1
2 Medium Lasers	LA	2	2
Medium Laser	LT (R)	1	1
Medium Laser	RT (R)	1	1
Small Laser	CT	1	1
Small Laser	H	1	1

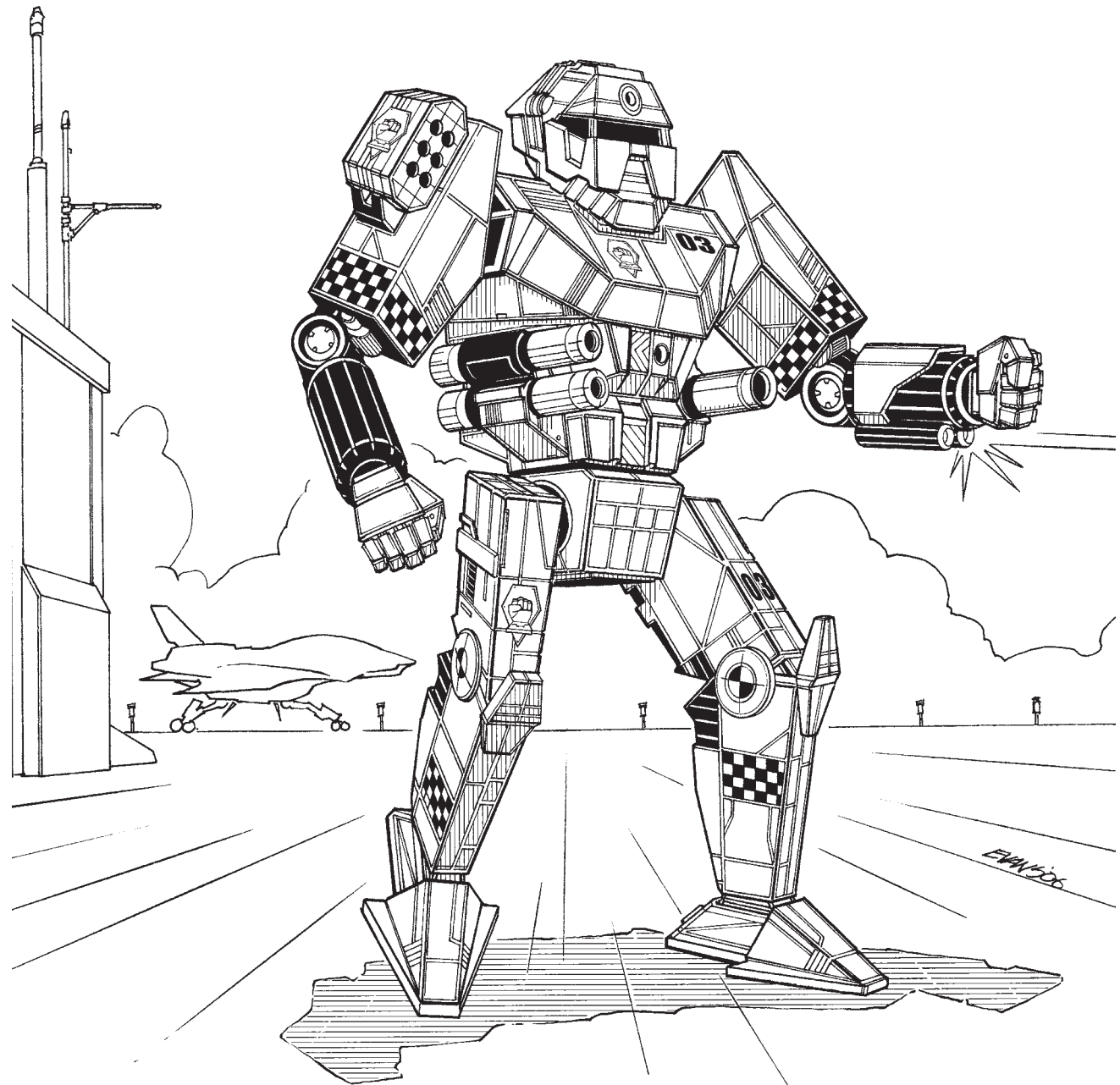

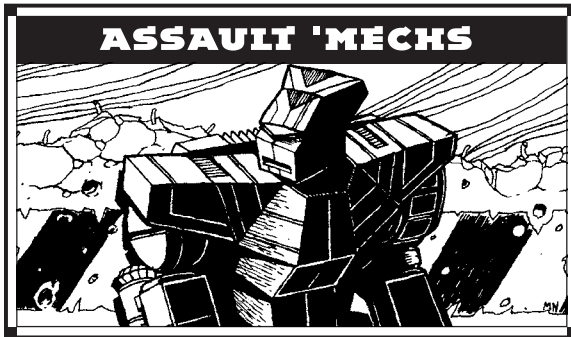

**Mass:** 100 tons

**Chassis:** Star League MN-01

**Power Plant:** Nissan 200

**Cruising Speed:** 21 kph

**Maximum Speed:** 32 kph

**Jump Jets:** None

**Jump Capacity:** None

**Armor:** Starshield Special-b with CASE

**Armament:**

4 Mydron Excel LB-10X Autocannon

4 Magna 400P Medium Pulse Lasers

**Manufacturer:** Arc-Royal MechWorks

**Primary Factory:** Arc-Royal

**Communications System:** Garret T19-G

**Targeting and Tracking System:** Wasat Aggressor  
Type 5

## Overview

One of the few remaining secrets belonging to the ravaged Wolf's Dragoons, many thought the *Annihilator* design would slowly disappear after the utter destruction of Outreach by the Word of Blake. Thus, when a new variant showed up in a recent battle on Graceland, it caught many by surprise.

Because of the close relationship between the Kell Hounds, Wolves (in-Exile), and Dragoons, many of these hard-to-obtain assault BattleMechs exchanged hands. Originally a design exclusive to the Dragoons (who seemingly had hoards of them stashed somewhere), *Annihilators* began popping up among all three mercenary units during the FedCom Civil War. Before the fall of the Second Star League, Kell Hound technicians were experimenting with newly acquired light

autocannon technology, using the *Annihilator* as a test bed. When coupled with compact engines and gyros, enough LACs were crammed into an *Annihilator*'s frame to make it a fearsome vehicle and infantry killer.

As the remnants of the Dragoons relocated to Arc-Royal, they brought what limited data they had from the remains of their now-destroyed computer network. With the original *Annihilator* data now available to them, Arc-Royal MechWorks managed to beef up the design to incorporate heavy PPCs, making the 'Mech a rival to many Clan second-line machines.

## Capabilities

Still produced in strong numbers, the ANH-2A *Annihilator* lives up to its fearsome name. Four LB-10X autocannons and matching pulse lasers make it a deadly foe in close-quarter fighting, though the light ammunition load tends to put aggressive pilots at a disadvantage in long battles. The compact frame and easy-to-repair components make the design a solid one, keeping downtime to a minimum.

When mated with new Lyran compact engines and gyros, more space is opened up in the cavernous torso without sacrificing its reparability. The new ANH-3A is a true terror to Demolisher II lances and a holy nightmare to even heavily-armored Kanazuchi armor squads.

Reportedly, visiting Hell's Horses merchants to the Wolf (in-Exile) enclave were impressed with both new variants they saw; rumors on the Chatterweb indicate a multi-caste deal may be in the making for either selling the 'Mech or possibly even a future co-venture on a new BattleMech design. Either way, it seems that the Exiles are continuing to expand their influence, further distancing themselves from utter dependence on the Alliance.

## Deployment

The older ANH-1A *Annihilators* are still seen among mercenary units but are decidedly rare. The most commonly seen *Annihilators* are the 2A variety, with the Kell Hounds and Exiles putting their production runs immediately up for sale to any non-Blakist buyers. The 3A and 4As have only been seen in service with Exile and Dragoon units—why the Hounds do not field these newer variants is still unknown at this time.

## Variants

Mounting more armor than the original 1A, eight light autocannons and four extended-range medium lasers, the ANH-3A is a terror to all but other assault 'Mechs. Capable of tearing even 100-ton tanks to shreds within seconds, it is a showpiece of Lyran, Dragoon, and Clan cooperation. Also deserving of such praise is the ANH-4A, which mounts two heavy-class PPCs, two LB-10X autocannons, and two light autocannons. With ample ammunition, a compact gyro and more armor, this design has caught the eye of several Hell's Horses merchants.

## Notable MechWarriors

**Captain Stephanie "Mean Baby" Peterson:** Stationed on Solaris VII when the Word of Blake struck, Peterson found herself among the ranks of the Dispossessed that joined Eric Gray's Solaris Home Defense League; her *Annihilator* was destroyed early in the fighting. She exposed a spy in the SHDL's midst a short time later and handily turned the tables on what would have been a well-laid trap for Gray and several other resistance leaders. Since then, she has used her youthful looks and single-minded focus to carry out other successful intelligence-gathering missions for the SHDL.

**Sergeant Major Bull Redmond:** Tasked with commanding the ragtag militia on Aiguebelle, Redmond keeps the two *Annihilators* assigned to his unit in pristine condition. As they are the only two BattleMechs in the system, a large part of his duty is traveling with the 'Mechs to various duty stations across the planet to perform what he calls "confidence missions." For some reason, the sight of the two menacing assault 'Mechs in Aiguebelle's colors help soothe the populace, especially during the increasingly bad news being broadcast from the media. Redmond's biggest headache outside of coordinating the two slow behemoths with the rest of the militia's hovercraft force is trying to find a MechWarrior replacement for his partner, who is retiring in six months.

# ANH-2A ANNIHILATOR

Type: **Annihilator**

Technology Base: Inner Sphere

Tonnage: 100

Battle Value: 1,595

## Equipment

Internal Structure:		10
Engine:	200	8.5
Walking MP:	2	
Running MP:	3	
Jumping MP:	0	
Heat Sinks:	17	7
Gyro:		2
Cockpit:		3
Armor Factor:	200	12.5

	Internal Structure	Armor Value
Head	3	9
Center Torso	31	25
Center Torso (rear)		10
R/L Torso	21	21
R/L Torso (rear)		9
R/L Arm	17	24
R/L Leg	21	24

## Weapons and Ammo

	Location	Critical	Tonnage
LB 10-X AC	RA	6	11
LB 10-X AC	LA	6	11
LB 10-X AC	RT	6	11
LB 10-X AC	LT	6	11
Ammo (LB-X) 20	RT	2	2
CASE	RT	1	.5
Ammo (LB-X) 20	LT	2	2
CASE	LT	1	.5
Medium Pulse Laser	LA	1	2
Medium Pulse Laser	RA	1	2
2 Medium Pulse Lasers	CT	2	4

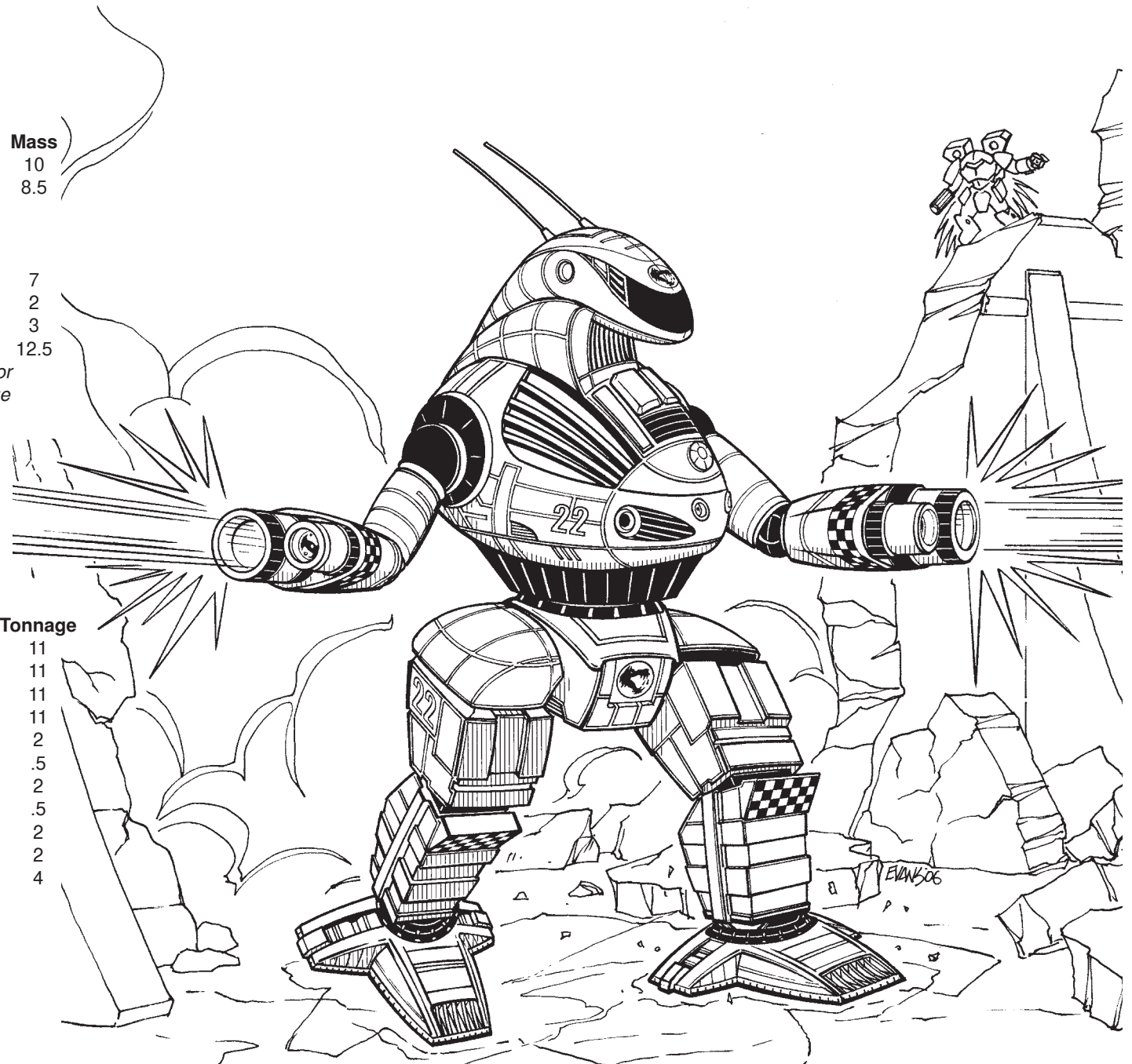

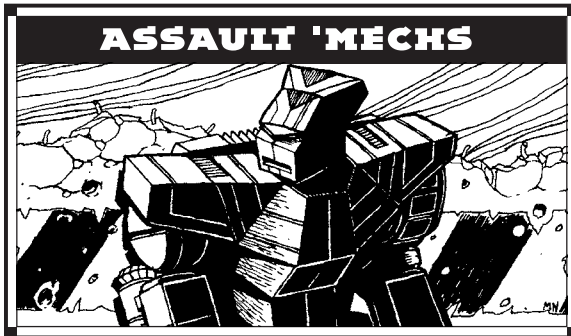

**Mass:** 100 tons

**Chassis:** Foundation Type 10X

**Power Plant:** Vlar 300 XL

**Cruising Speed:** 32 kph

**Maximum Speed:** 54 kph

**Jump Jets:** None

**Jump Capacity:** None

**Armor:** Durallex Special Heavy with CASE

**Armament:**

1 Dragon's Fire Gauss Rifle

1 Shigunga LRM-20 Rack

2 Victory Nickel Alloy Extended-Range  
Large Lasers

2 Victory Heartbeat Medium Pulse Lasers

1 Yori Flyswatter Anti-Missile System

**Manufacturer:** Yori Mech Works,  
Independence Weaponry

**Primary Factory:** Al Na'ir (Yori),  
Quentin (Independence)

**Communications System:** Sipher Security Plus

**Targeting and Tracking System:** Matabushi Sentinel

## Overview

Once known as the ultimate assault BattleMech, the *Atlas* had many looking forward to the upgrades it would receive as the technological renaissance and the Clan Invasion swept through the Inner Sphere. As the Draconis Combine debuted the AS7-K variant to its forces, fans of the design were pleased with how well the machine had kept up with the times.

## Capabilities

During the rush to upgrade existing BattleMechs, the *Atlas* was transformed from a short-ranged brawler

to a long-range bombardier. The highly desired Gauss rifle replaced the super-heavy autocannon, sacrificing damage for a low-heat long-range ability. Keeping the LRM-20 rack, designers solved a recurring jamming problem by giving each missile its own launch tube and installed CASE in each torso to protect the pilot from fatal ammunition explosions; a testament to the speed of this upgrade, however, the housing for the original compact LRM 20 launcher on the left hip is still present. The biggest change was sacrificing the SRM rack to change the arm-mounted lasers to large extended-range variants.

To make room for all these improvements, a Vlar 300 extra-light fusion engine was rushed through design and testing to be ready for mounting on the heavy chassis. Initial plans called for double heat sinks to provide space for additional weaponry, but engineers were unable to perfect the Vlar in time for the deadline. This gave the 7-K *Atlas* a brutal heat curve when using both its ER lasers at the same time. For defensive measures the rear medium lasers were upgraded to pulses, and a Yori Flyswatter anti-missile system was mounted to protect the machine from the initial missile bombardments that often seek to soften up armor.

## Deployment

Despite being an ancient design, or perhaps because of it, the *Atlas*' reputation on the battlefield is unquestioned. Even state-of-the-art designs often give the design a wide berth and instead attempt to engage a less proven BattleMech such as a *Berserker* or *Akuma*. This has always kept sales brisk, and there is still no projected date for this flagship of all BattleMechs to be replaced.

On Al Na'ir, in a firefight that occurred in early 3069, a lance of corporate-owned *Atlases* held off a wave of Blakist troops while defending a dome settlement for several days. Eventually the defenders succumbed to penetrating torso hits, depressurizing and crippling the bulky extra-light fusion engines.

## Variants

A much less extensive modification, the former FedCom AS7-S variant was put into production shortly after the K model was released. By using double heat

sinks, not only was a pair of Streak-2 SRMs mounted on the rear torsos, but it also allowed the design to safely alpha strike with its front-mounted weapons. Not in production today, many FedSun militias keep their S variants and equip them with the advanced autocannon rounds, while Lyrans use special LRM munitions captured from the FWLM.

Replacing the S line shortly before the outbreak of the FedCom Civil War, the S2 *Atlas* produced at Hesperus II more closely resembled the popular K variant produced in the Combine. However, this model mounted a much more resilient light fusion engine, along with double heat sinks to compensate for the heat produced by the pair of ER large lasers. A heavy Gauss rifle and an Artemis-equipped LRM-15 rack add to the hefty firepower, while a Guardian ECM replaces the anti-missile system and rear firing lasers.

The Draconis Combine, on the other hand, never modified their original K production lines once they solved the issue of producing double heat sinks. They did, however, issue field refit kits to units who accepted the C<sup>3</sup> technology, with the C kit sacrificing a medium pulse for an extra heat sink and a C<sup>3</sup> slave, and a lance commander CM kit switching a large laser for a C<sup>3</sup> Master system.

## Notable MechWarriors

**Major Joel Agee:** A rapier-sharp tactical mind allowed Major Agee to do more with less against the pirates and other threats facing Canopus, exactly the sort of military asset management that the Periphery nation required. He climbed through the Canopian military ranks despite his gender and relative poverty, and wise investment of profits from media appearances and a line of animated action figures allowed him to invest in prospering Canopian medical companies. Those, in turn, afforded Agee the restoration of a wrecked AS7-K in 3060. The massive war machine is rare among Canopian units, and Major Agee has used its massive firepower to achieve further victories, cementing his status as a rising star.

# AS7-K ATLAS

Type: **Atlas**

Technology Base: Inner Sphere

Tonnage: 100

Battle Value: 2,175

## Equipment

Internal Structure:

Engine:

Walking MP:

Running MP:

Jumping MP:

Heat Sinks:

Gyro:

Cockpit:

Armor Factor:

	Mass
300 XL	9.5
3	
5	
0	
20	10
	3
	3
304	19

	Internal Structure	Armor Value
--	--------------------	-------------

Head

Center Torso

Center Torso (rear)

R/L Torso

R/L Torso (rear)

R/L Arm

R/L Leg

3	9
31	47
	14
21	32
	10
17	34
21	41

## Weapons and Ammo

Gauss Rifle

Ammo (Gauss) 16

CASE

LRM 20

Ammo (LRM) 12

CASE

ER Large Laser

ER Large Laser

2 Medium Pulse Lasers CT (R)

Anti-Missile System

Ammo (AMS) 12

Location	Critical	Tonnage
RT	7	15
RA	2	2
RT	1	.5
LT	5	10
LT	2	2
LT	1	.5
LA	2	5
RA	2	5
CT (R)	2	4
LA	1	.5
LT	1	1

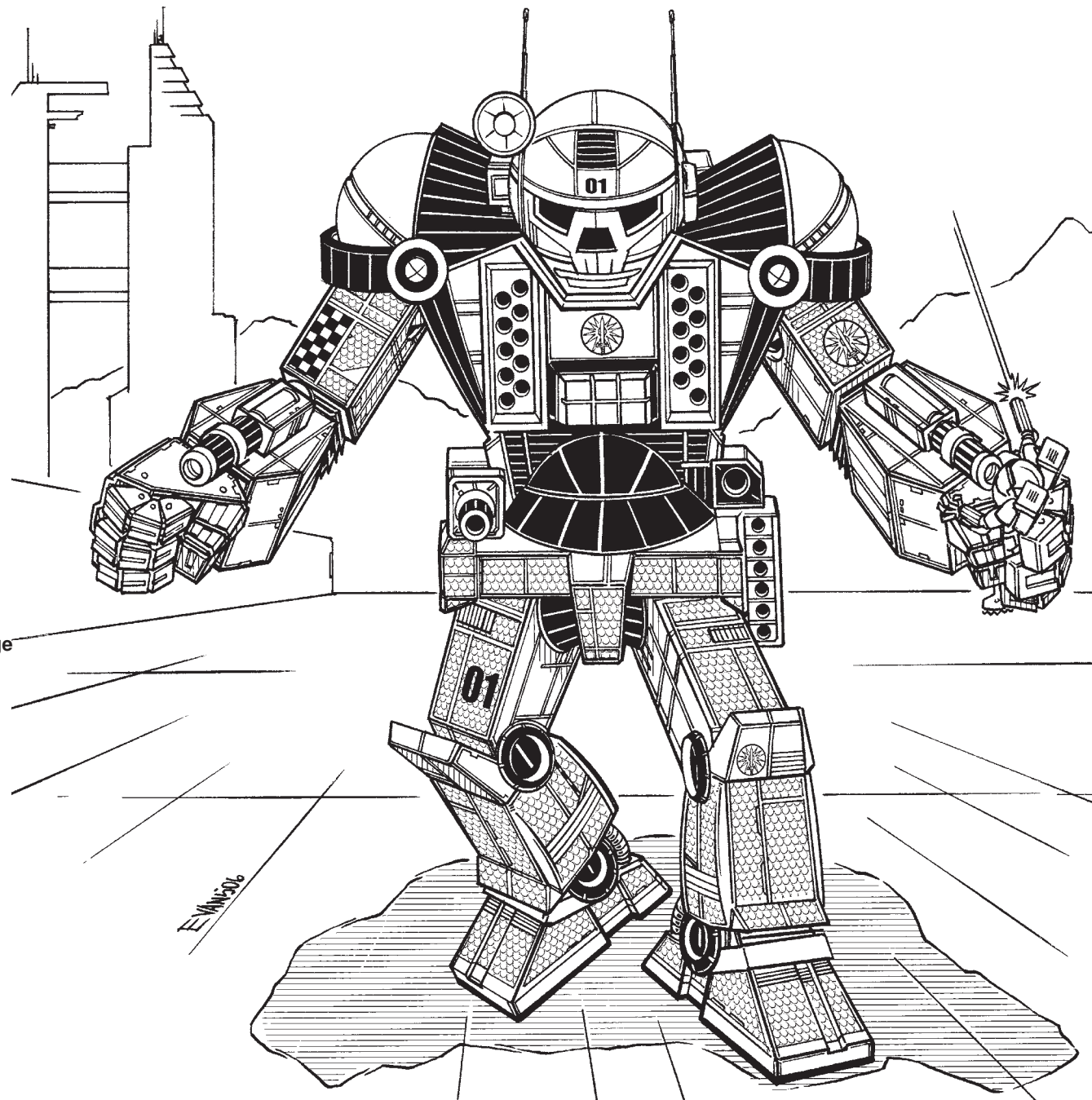

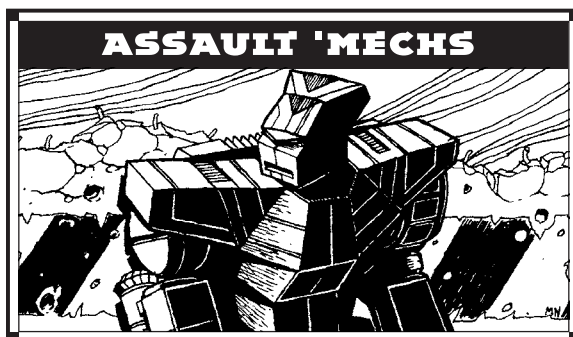

**Mass:** 100 tons

**Chassis:** Star League IM-03x

**Power Plant:** Vlar 300 XL

**Cruising Speed:** 32 kph

**Maximum Speed:** 54 kph

**Jump Jets:** None

**Jump Capacity:** None

**Armor:** Maximillian 300

**Armament:**

2 Magna Firestar Extended-Range PPC

1 Mitchell Systems LRM-15

1 Thunderbolt-12 Large Pulse Laser

2 Magna 400P Medium Pulse Lasers

2 Martell Model 5 Medium Lasers

**Manufacturer:** GM Blackwell of Outreach

**Primary Factory:** Outreach

**Communications System:** Pauley-Bronson Z

**Targeting and Tracking System:** Wasat Aggressor

Type 8

## Overview

The *Imp*'s original appearance among Wolf's Dragoons confused ComStar's ROM in the early 31st century, though the revelation of the Dragoons' origins and over two decades of scrutiny into the Clans has finally uncovered the mysterious origins of the machine. Once thought to be a forgotten Star League prototype, this 'Mech actually debuted soon after General Aleksandr Kerensky settled the Pentagon worlds, born as a symbol of the strength of a self-declared Star League in Exile and nearly forgotten before the end of their Golden Century.

## Capabilities

At 100 tons, the *Imp* stresses armor and firepower over speed and finesse. The 'Mech is a barely humanoid gun platform, packing an arsenal of medium lasers, pulse lasers, and ER PPCs backed up by an LRM-15 rack. As impressive as this weapons array is, however, the IMP-3E suffers from massive heat build-up that inhibits its ability to fire all of its weapons together.

## Deployment

The appearance of 'Mechs like the *Imp* in Wolf's Dragoons' TO&E when they first arrived in the Inner Sphere is seen today as one of the few major missteps they made upon their arrival. Apparently chosen for its ancient nature, the Clans must have presumed that the *Imp*'s design actually dated back to the Star League as it fell, rather than its self-exiled children, though how such an error could have occurred is anyone's guess.

Rather than cover up the mistake by simply making their *Imps* disappear, however, the Dragoons allowed them to be seen and even sought the means to build more by entering into a business partnership with GM Blackwell, never explaining the slip and leaving it as part of the unique mystique that helped win them so many contracts through the following decades.

Beyond the Dragoons, the *Imp* remains rare, spotted mostly in the second-line touman of Clan Star Adder back in the homeworlds. Most analysts agree that the rarity of these machines reinforces the view that they have long since been phased out by Kerensky's descendants in favor of newer and more capable designs.

## Variants

In retrospect, the first-sighted model of the *Imp*, the IMP-2E, was apparently a deliberate downgrade of the IMP-3E that the Wolf's Dragoons tried to pass off as a forgotten product of Succession Wars decline. Using a much heavier Strand 300 standard engine and an arsenal of twin Magna Hellstar PPCs, five Martell-5 medium lasers, and an LRM-15, the machine walked and talked as advertised, but its Star League-inspired design lines and the lack of records on its manufacture still set off warnings in the intelligence communities of the Successor States and ComStar alike.

The 4E model *Imp*, which debuted in 3060, represented the Dragoons' second overhaul of the design, upgrading the heat sinks to double-strength freezers and using their greater efficiency to reduce the tonnage spent on heat exchange to realign the weapons load. This up-gunned model mounts an ER PPC in each side torso, three ER medium lasers (one each in the arms and head), twin center-mounted medium pulse lasers, and an ER small laser in each leg. In addition, the right arm LRM is upgraded to an Artemis-equipped 20-rack, providing greatly improved damage potential all around.

It was also discovered at this time that a Clan-made version—the so-called *Imp C*—existed in some Clan arsenals, and that even some of the Dragoon models were being built to the Clan standard. These models retain the same base chassis and standard engine design but use twenty-five Clan-made double heat sinks to vent the heat generated by a weapons array consisting of two ER PPCs, an Artemis-enhanced LRM-20, and five medium pulse lasers.

Naturally, with the obliteration of their Outreach factories, the Dragoons cannot produce new *Imps*, but there are whispers that the Arc-Royal factories, Spheroid-controlled Arc-Royal MechWorks and those of the exiled Wolves, are looking into starting their own *Imp* lines using Dragoon schematics.

## Notable MechWarriors

**Leutenant Amber "Snuggles" Kaulback:** Jockeying an *Imp* 4E of uncertain pedigree, this Lyran Mechwarrior has been a stalwart defender of Tharkad since the LCS Invincible bombarded Tharkad City. Tharkad's media calls the young woman "*Snuggles*" for her unique anti-BattleMech grappling attack, but the LAAF origins of the nickname are her shouted "Snuggle up!" order to move into close contact with Blakist ground units when Blakist warships are overhead. This and other well-applied, elementary tactics have kept Kaulback and her ad hoc lance together during the years of the Blakist siege.

# IMP-3E IMP

Type: **Imp**  
 Technology Base: Inner Sphere  
 Tonnage: 100  
 Battle Value: 1,906

**Equipment**

Internal Structure:		10
Engine:	300 XL	9.5
Walking MP:	3	
Running MP:	5	
Jumping MP:	0	
Heat Sinks:	30	20
Gyro:		3
Cockpit:		3
Armor Factor:	288	18

	<i>Internal Structure</i>	<i>Armor Value</i>
Head	3	9
Center Torso	31	40
Center Torso (rear)		21
R/L Torso	21	30
R/L Torso (rear)		12
R/L Arm	17	25
R/L Leg	21	42

**Weapons and Ammo**

	Location	Critical	Tonnage
ER PPC	RT	3	7
ER PPC	LT	3	7
LRM 15	RA	3	7
Ammo (LRM) 16	LT	2	2
CASE	LT	1	.5
Large Pulse Laser	LA	2	7
2 Medium Pulse Lasers	CT	2	4
2 Medium Lasers	RT	2	2

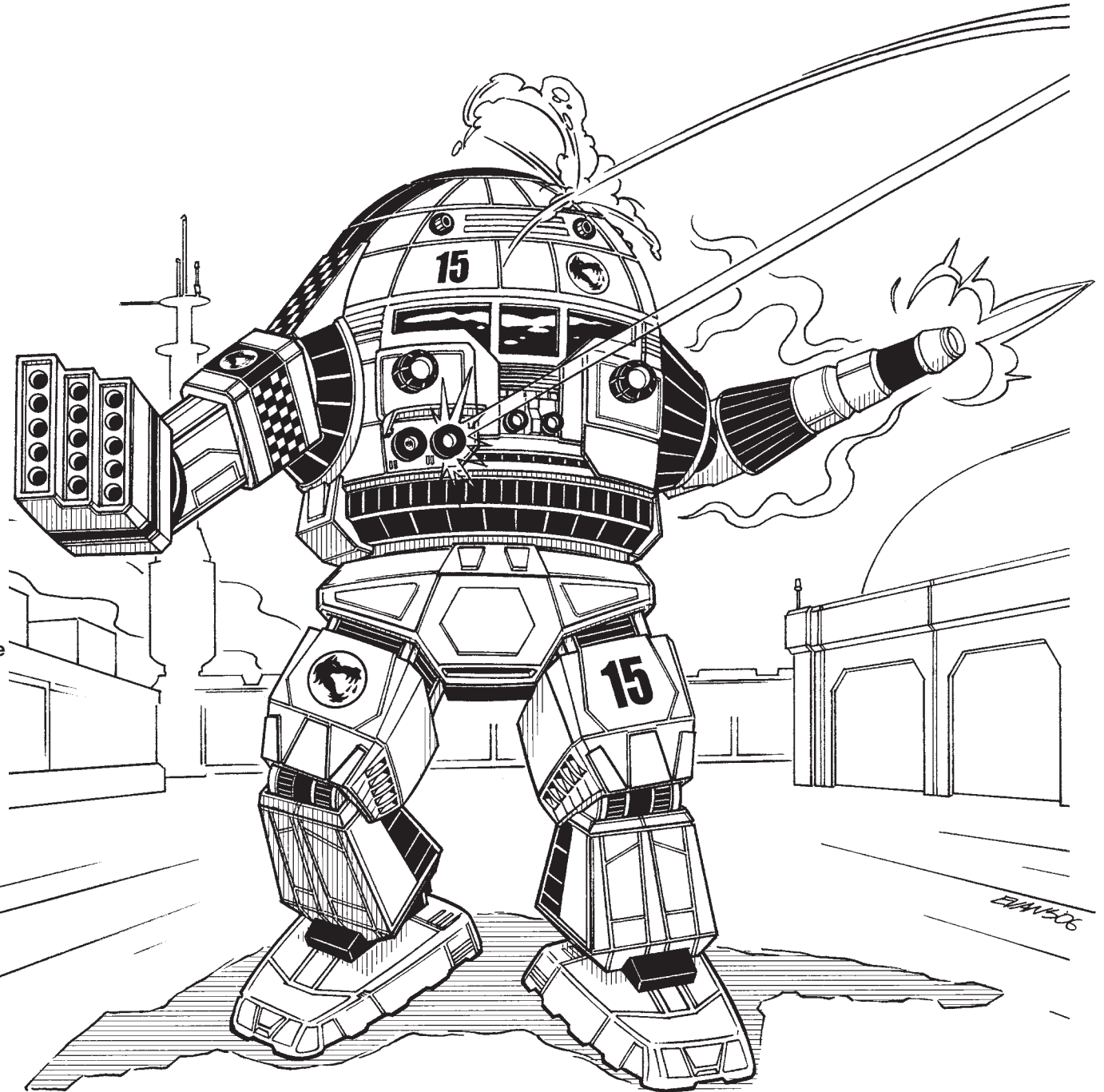

EDWARDS



**W**hile the Inner Sphere was demolishing its industrial and technological base during the Succession Wars, the descendents of Aleksandr Kerensky's followers were building upon those same foundations. The Scientist Caste perfected what is arguably the "Ultimate BattleMech" in the form of the Omnimech. The basic concept dates back to the final decades of the first Star League, when the *Mercury* introduced the idea of using modular weapons to speed up repair and maintenance. Clan Coyote expanded on this and fielded their first Omnimechs in 2854. Other Clans were soon competing to acquire the technology, and by the close of the century frontline formations were almost exclusively composed of Omnimechs.

Omnimechs go beyond the concepts pioneered in the *Mercury*, as that Star League design's weapon configuration was fixed even if the weapons were modularized. Any alteration required the same time-consuming updates to targeting and control systems that all BattleMech modifications require. The key to the Omnimech is that the control systems can automatically adapt to reconfiguration. Thus the same 'Mech that provided fire support one day can be reconfigured for urban combat the next. Another advantage is the reduction in time required for maintenance and repair. Damaged weapons modules or even whole limbs can be swapped out. The entire 'Mech seldom needs to be taken out of service for maintenance because most of its parts can be serviced independently.

Of course the flexibility offered by the Omnimech is not the only advantage the Clans enjoy over the Inner Sphere. Not even the discovery of a Star League memory core in 3028 was enough to prepare the Inner Sphere for the Clan's technological edge. Just as they had improved on the modular 'Mech concept, the Clans have spent almost two centuries improving the same weapon systems that the Inner Sphere has only recently rediscovered.

The Omnimech concept underwent one major modification with the development of Battle Armor in 2868. The unique ability to dynamically adjust to the redistribution of weight that accompanies reconfiguration also enabled an Omnimech to handle the movements of several thousand kilograms of Elementals. Communication and power ports became standard on all Omnimech designs, allowing the Clans to perfect their Mechanized Battle Armor doctrine.

The sixteen Omnimechs described in the following pages were the most common designs employed by the Clans when they launched their invasion of the Inner Sphere in 3050. When earlier editions of this document were published, the Inner Sphere lacked intelligence sources that could provide specific details. With little to work with except battlefield reports, it is no surprise that the results were vague at best and sometimes wildly inaccurate. For this revised edition I have compiled technical and historical documentation from Clan Wolf archives and from information acquired by the Watch from the other Clans.

As denizens of the Inner Sphere will be the primary user of this publication, the designations given to these Omnimechs by the intelligence community are used in preference to their official Clan ones.

—Khan Phelan Kell







**Mass:** 20 tons  
**Chassis:** Dominator Light-Alpha 20  
**Power Plant:** Firebox 200 XL  
**Cruising Speed:** 108 kph  
**Maximum Speed:** 162 kph, 216 w/MASC  
**Jump Jets:** None  
**Jump Capacity:** None  
**Armor:** IceSheet Ferro Fibrous  
**Armament:**  
 6.5 tons of pod space available  
**Manufacturer:** Dominion Facility Kappa-4 and -5  
**Primary Factory:** Goito, Thule  
**Communications System:** Untermarkt IV-a  
**Targeting and Tracking System:** Hakkø MicroSystems

## Overview

Originally developed by the Cloud Cobras to the prototype stage before being abandoned, the *Dasher* (Fire Moth to the Clans) was designed as an infantry-support platform first and a strike unit second. The first *Dasher* incarnation had a strange infantry pod slung under the OmniMech's arms, forcing the reinforcement of the torso. The unusual arms were mounted to accommodate the bulky cargo pods.

The infantry pods were discarded after the first prototype was field-tested—primarily due to derisive comments suggesting this was “crazy as a Mandrill idea.” Combined with repeated problems in reducing the MASC failure rate, the Cobras “lost” the design to the Ghost Bears for a five-year trade agreement.

The Ghost Bears left the arms mounted high due to balance problems with “properly” mounted arms on the odd chassis. In retrospect, this was one of the best decisions Bear scientists made with the *Dasher*. It was found

that accidental brush-offs of the newly developed battle armor were near zero percent on *Dashers*, as opposed to near seven percent with other standard biped frames. The upper-mounted arms also allowed Elementals riding on the sides to dismount faster, making the *Dasher* ideal for swift battlefield deployment of armored infantry.

Though extensively utilized by the Ghost Bears, the *Dasher* is unpopular with other Clans, who consider the ungainly OmniMech too light and defenseless for more BattleMech-oriented combat. When the Bears relocated to the Dominion, they were able to dismantle their two *Dasher* assembly plants and transplant them to Goito and Thule. They currently trade their newer upgrades through the Diamond Sharks to the Exiled Wolves, who also use the design in infantry-support missions.

## Capabilities

One of the fastest OmniMechs built by the Clans, the *Dasher* can easily dismantle most Inner Sphere light 'Mechs. Many Clan warriors use *Dashers* in various trials, as the 'Mech rarely mounts heavy weapons capable of killing a warrior and requires skill to take down their opponent.

Clans such as the Ghost Bears, Horses, and Wolves-in-Exile have been known to field several Stars' worth of this design as an infantry-support and delivery mechanism. Warriors of such OmniMechs are usually not Bloodnamed and on the slide towards solahma, meaning they tend to be very aggressive in their tactics.

## Deployment

Primarily seen among the Horses and Bears, most warriors piloting *Dashers* tend to gravitate towards the heavier weapon configurations such as the Prime, D, F, and H. The C has found some use as a fast-moving support machine among the Horses. The newly-seen K configuration is currently fielded only among the warriors of the Ghost Bears' Omega Galaxy, who seem to have taken to the infantry-support loadout.

## Notable MechWarriors

**saKhan Aletha Kabrinski:** A natural tactician and highly skilled MechWarrior, Kabrinski never let the *Dasher's* lack of firepower stand in the way of her goals. Her meteoric rise from Star Captain to saKhan of the Ghost Bears exemplifies this drive. Utilizing her 'Mech's speed and agility, she revels in “skillful kills,” leading many to wonder if she has some Goliath Scorpion blood.

Type: **Fire Moth**

Inner Sphere Designation: **Dasher**

Technology Base: Clan OmniMech

Tonnage: 20

Battle Value: 1,057

## Equipment

Equipment	Internal Structure	Endo Steel	Mass
Internal Structure:	200 XL		1
Engine:		200 XL	4.5
Walking MP:		10	
Running MP:		15 (20)	
Jumping MP:		0	
Heat Sinks:		10 [20]	0
Gyro:			2
Cockpit:			3
Armor Factor:	38		2
	Internal Structure	Armor Value	
Head	3	5	
Center Torso	6	5	
Center Torso (rear)		2	
R/L Torso	5	4	
R/L Torso (rear)		2	
R/L Arm	3	3	
R/L Leg	4	4	

## Weight and Space Allocation

Location	Fixed	Spaces Remaining
Head	1 Ferro-Fibrous	0
Center Torso	MASC	0
	1 Endo Steel	
Right Torso	2 XL Engine	5
	2 Ferro-Fibrous	
	1 Endo Steel	
	Double Heat Sink	
Left Torso	2 XL Engine	5
	2 Ferro-Fibrous	
	1 Endo Steel	
	Double Heat Sink	
Left Arm	1 Ferro-Fibrous	6
	1 Endo Steel	
Right Arm	1 Ferro-Fibrous	6
	1 Endo Steel	
Right Leg	1 Endo Steel	1
Left Leg	1 Endo Steel	1

## Weapons and Ammo

Location	Critical	Tonnage
<i>Primary Weapons Configuration</i>		
SRM 6	RA	1 1.5
Ammo (SRM) 15	RA	1 1
SRM 4	RT	1 1
Ammo (SRM) 25	RT	1 1
2 ER Medium Lasers	LA	2 2

**Weapons and Ammo Location Critical Tonnage**
*Alternate Configuration A*

TAG	RA	1	1
Active Probe	RA	1	1
Streak SRM 4	RT	1	2
Ammo (Streak) 25	RT	1	1
Anti-Missile System	LA	1	.5
Ammo (AMS) 24	LA	1	1
Battle Value: 589			

*Alternate Configuration B*

ECM Suite	RA	1	1
2 Machine Guns	RA	2	.5
Ammo (MG) 200	RA	1	1
Medium Pulse Laser	RT	1	2
Medium Pulse Laser	LA	1	2
A-Pod	RL	1	.5
Battle Value: 922			

*Alternate Configuration C*

LRM 5	RA	1	1
Ammo (LRM) 24	RA	1	1
Anti-Missile System	RT	1	.5
Ammo (AMS) 48	RT	2	2
LRM 5	LA	1	1
Ammo (LRM) 24	LA	1	1
Battle Value: 679			

*Alternate Configuration D*

2 ER Medium Laser	RA	2	2
ER Medium Laser	RT	1	1
Targeting Computer	RT	1	1
Flamer	RT	1	.5
2 ER Medium Lasers	LA	2	2
Battle Value: 1,916			

*Alternate Configuration E*

ATM 6	RA	3	3.5
Ammo (ATM) 30	RA	3	3
Battle Value: 674			

*Alternate Configuration F*

3 AP Gauss Rifles	RA	3	1.5
Ammo (APGauss) 40	RA	1	1
3 ER Medium Lasers	LA	3	3
Active Probe	LT	1	1
Battle Value: 1,232			

*Alternate Configuration H*

5 Heavy Small Lasers	RA	5	2.5
Targeting Computer	RT	1	1
Double Heat Sink	RT	2	1
4 Heavy Small Lasers	LA	4	2
Battle Value: 674			

**Weapons and Ammo Location Critical Tonnage**
*Alternate Configuration K*

Heavy Medium Laser	RA	2	1
3 Light Machine Guns	RA	3	.75
Machine Gun Array	RA	1	.25
Heavy Medium Laser	LA	2	1
3 Light Machine Guns	LA	3	.75
Machine Gun Array	LA	1	.25
Ammo (MG) 100	LT	1	.5
B-Pod	RL	1	1
B-Pod	LL	1	1
Battle Value: 713			

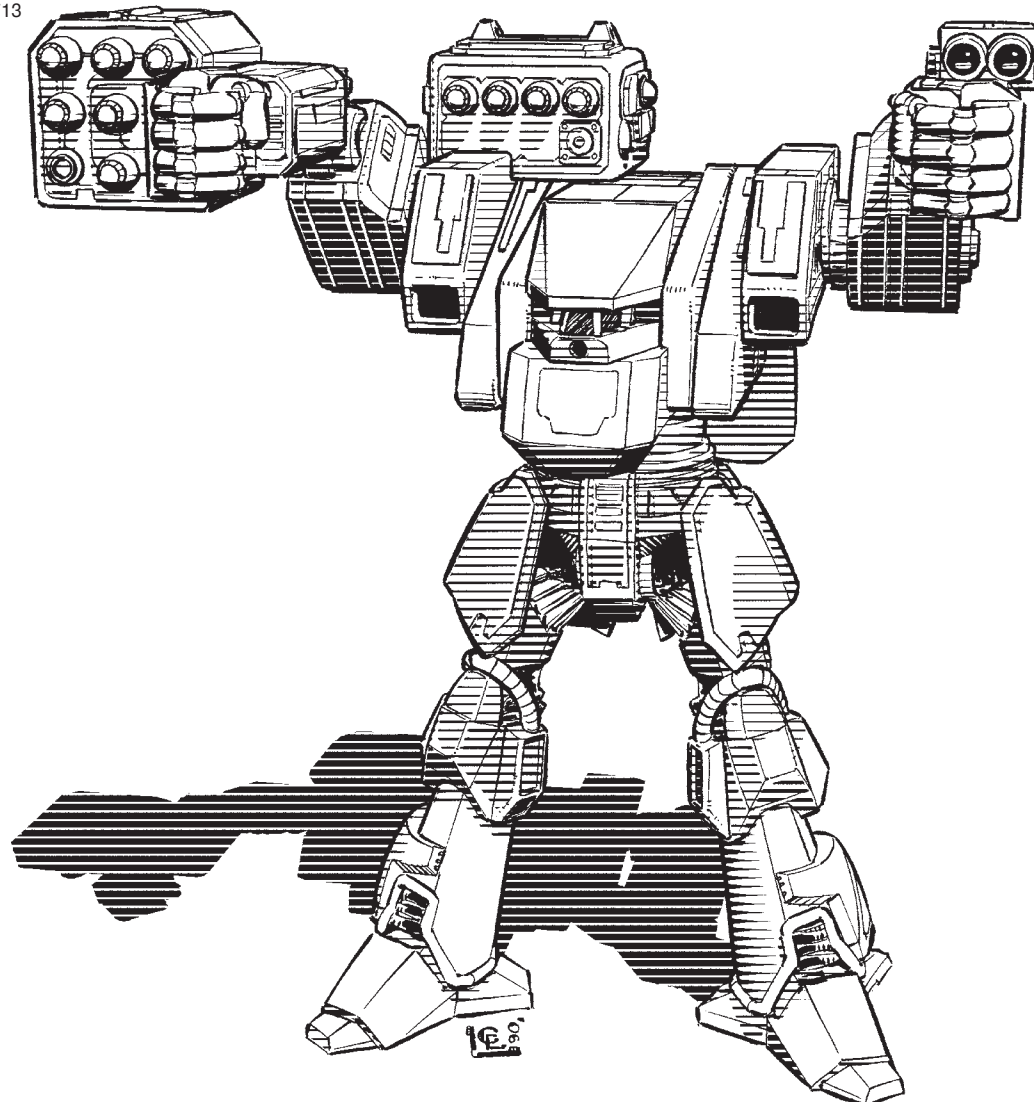



**Mass:** 25 tons  
**Chassis:** Light Series II Endo-steel  
**Power Plant:** Type II 175 XL  
**Cruising Speed:** 75 kph  
**Maximum Speed:** 118 kph  
**Jump Jets:** Clan Light Series Mk. I  
**Jump Capacity:** 180 meters  
**Armor:** Compound H17 Ferro-Fibrous  
**Armament:**  
 7.5 tons of pod space available  
**Manufacturer:** Huntress Production Facility Epsilon,  
 Arcadia BattleMech Plant CM-O3  
**Primary Factory:** Huntress, Arcadia  
**Communications System:** Build 1685/5 Tacticom  
**Targeting and Tracking System:** Series III GDS  
 with Active Probe

## Overview

Designed and produced in the early decades of the 30th century by Clan Smoke Jaguar technicians, the *Koshi* filled the role of light scout and raider ably until contact with the Inner Sphere proved its vulnerabilities. Nevertheless, the 'Mech remains in frontline service, though notably in more deadly modern configurations.

## Capabilities

The *Koshi*, aka *Myst Lynx*, is not the fastest OmniMech in Clan service, but it is the fastest of the dedicated recon platforms. It also has a full 180-meter jump capacity, among the greatest of any of the known standard OmniMech configurations—only the *Viper* exceeds and the *Hankyu* equals it. This nearly unmatched maneuverability is what has kept it such a viable battlefield unit for so long, despite its mere three and a half tons of ferro-fibrous armor.

The 'Mech permanently mounts an active probe, which still leaves seven and a half tons for weapons pods and other mission equipment. No less than ten unique standard configurations of the *Myst Lynx* have been identified since the Clan Invasion. The first four all seem to center around missiles, carrying either SRM racks or anti-missile systems. The fifth stands out from the rest in that it mounts the lightest Ultra autocannon. The rest focus more on close-range assault, making good use of recently developed and incredibly devastating Clan weapons systems. The P mounts an array of laser weapons, the typical E model carries an advanced tactical missile system, and both the F and H focus on heavy lasers. The most recently introduced configuration, the G, carries two quad-heavy machine gun arrays in addition to four ER small lasers.

## Deployment

After almost a century and a half in service, the *Koshi* has found its way into the toumans of every Clan. The Smoke Jaguars were the largest user of the 'Mech until their Annihilation, a fact that, while not lost upon other Clans, has not much discouraged its use. Two factories continue to produce new *Koshis* even today for Clans Ice Hellion and Steel Viper on Huntress and Arcadia, respectively.

## Notable MechWarriors

**Star Captain Eric:** An Ice Hellion of the Urgans Bloodline, Star Captain Eric won notoriety for himself during the Hellions' campaign against the Jade Falcons on Barcella. Leading charge after charge against the heavier and better armed Falcons, he and his Hellions had only maneuverability on their side. They won the battle, but Eric was the only member of his Supernova Binary to survive. He leads the Binary now, which in every battle since has suffered seventy percent casualties or greater.

**Commander Horst:** Commander Horst is a minor bounty hunter working the Combine side of the Occupation Zone in his "*Myst Warrior*." Though he regularly hunts down rogues and brigands for the DCMS, he gleefully jumps on any chance to pursue Clansmen. Some think he is a former Clansman himself; if so, he long ago gave up on the concept of zellbrigen, at least when fighting those he believes to be criminals.

Type: **Mist Lynx**

Inner Sphere Designation: **Koshi**  
 Technology Base: Clan OmniMech  
 Tonnage: 25  
 Battle Value: 880

Equipment		Mass
Internal Structure:	Endo Steel	1.5
Engine:	175 XL	3.5
Walking MP:	7	
Running MP:	11	
Jumping MP:	6	
Heat Sinks:	10 [20]	0
Gyro:	2	
Cockpit:		3
Armor Factor:	67	3.5
	<i>Internal Structure</i>	<i>Armor Value</i>
Head	3	9
Center Torso	8	10
Center Torso (rear)		6
R/L Torso	6	7
R/L Torso (rear)		5
R/L Arm	4	4
R/L Leg	6	5

## Weight and Space Allocation

Location	Fixed	Spaces Remaining
Head	Active Probe	0
Center Torso	1 Endo Steel	0
	1 Ferro-Fibrous	
Right Torso	2 XL Engine	2
	Double Heat Sink	
	3 Jump Jets	
	1 Endo Steel	
Left Torso	2 Ferro-Fibrous	0
	2 XL Engine	
	2 Double Heat Sinks	
	3 Jump Jets	
	1 Endo Steel	
Right Arm	2 Ferro-Fibrous	6
	1 Endo Steel	
Left Arm	1 Ferro-Fibrous	6
	1 Endo Steel	
	1 Ferro-Fibrous	
Right Leg	1 Endo Steel	1
Left Leg	1 Endo Steel	1

## Weapons and Ammo Location Critical Tonnage

### Primary Weapons Configuration

Streak SRM 4	RA	1	2
2 Machine Guns	RA	2	.5
Ammo (Streak) 25	RA	1	1
Ammo (MG) 100	RA	1	.5
LRM 10	LA	1	2.5
Ammo (LRM) 12	LA	1	1

**Weapons and Ammo Location Critical Tonnage**
*Alternate Configuration A*

Flamer	RA	1	.5
2 Machine Guns	RA	2	.5
Ammo (MG) 100	RA	1	.5
TAG	LA	1	1
2 Anti-Missile Systems	LA	2	1
Ammo (AMS) 72	LA	3	3
A-Pod	RL	1	.5
A-Pod	LL	1	.5

Battle Value: 620

*Alternate Configuration B*

2 SRM 6	RA	2	3
ER Small Laser	RA	1	.5
Ammo (SRM) 30	RA	2	2
2 ER Medium Lasers	LA	2	2

Battle Value: 1,218

*Alternate Configuration C*

ER Large Laser	RA	1	4
ER Medium Laser	RA	1	1
ECM Suite	LA	1	1
Anti-Missile System	LA	1	.5
Ammo (AMS) 24	LA	1	1

Battle Value: 1,330

*Alternate Configuration D*

ER Medium Laser	RA	1	1
ER Small Laser	RA	1	.5
Ultra AC/2	LA	2	5
Ammo (Ultra) 45	LA	1	1

Battle Value: 851

*Alternate Configuration E*

4 ER Small Lasers	RA	4	2
ATM 6	LA	3	3.5
Ammo (ATM) 20	LA	2	2

Battle Value: 1,007

*Alternate Configuration F*

2 Heavy Medium Lasers	RA	4	2
2 Heavy Small Lasers	RA	2	1
ECM Suite	RT	1	1
Targeting Computer	RT	1	1
Heavy Medium Laser	LA	2	1
2 Heavy Small Lasers	LA	2	1
Light TAG	LA	1	.5

Battle Value: 1,198

**Weapons and Ammo Location Critical Tonnage**
*Alternate Configuration G*

4 Heavy Machine Guns	RA	4	2
Machine Gun Array	RA	1	.25
ER Small Laser	RA	1	.5
Ammo (Heavy MG) 100	RT	1	1
4 Heavy Machine Guns	LA	4	2
Machine Gun Array	LA	1	.25
ER Small Laser	LA	1	.5
ER Small Laser	RL	1	.5
ER Small Laser	LL	1	.5

Battle Value: 816

*Alternate Configuration H*

2 Heavy Small Lasers	RA	2	1
Heavy Medium Laser	RA	2	1
Streak SRM 6	LA	2	3
Anti-Missile System	LA	1	.5
Ammo (Streak) 15	LA	1	1
Ammo (AMS) 24	LA	1	1

Battle Value: 991

*Alternate Configuration P*

ER Large Laser	RA	1	4
2 ER Micro Lasers	RA	2	.5
Micro Pulse Laser	RA	1	.5
Double Heat Sink	RT	2	1
2 ER Micro Lasers	LA	2	.5
2 Micro Pulse Lasers	LA	2	1

Battle Value: 1,074

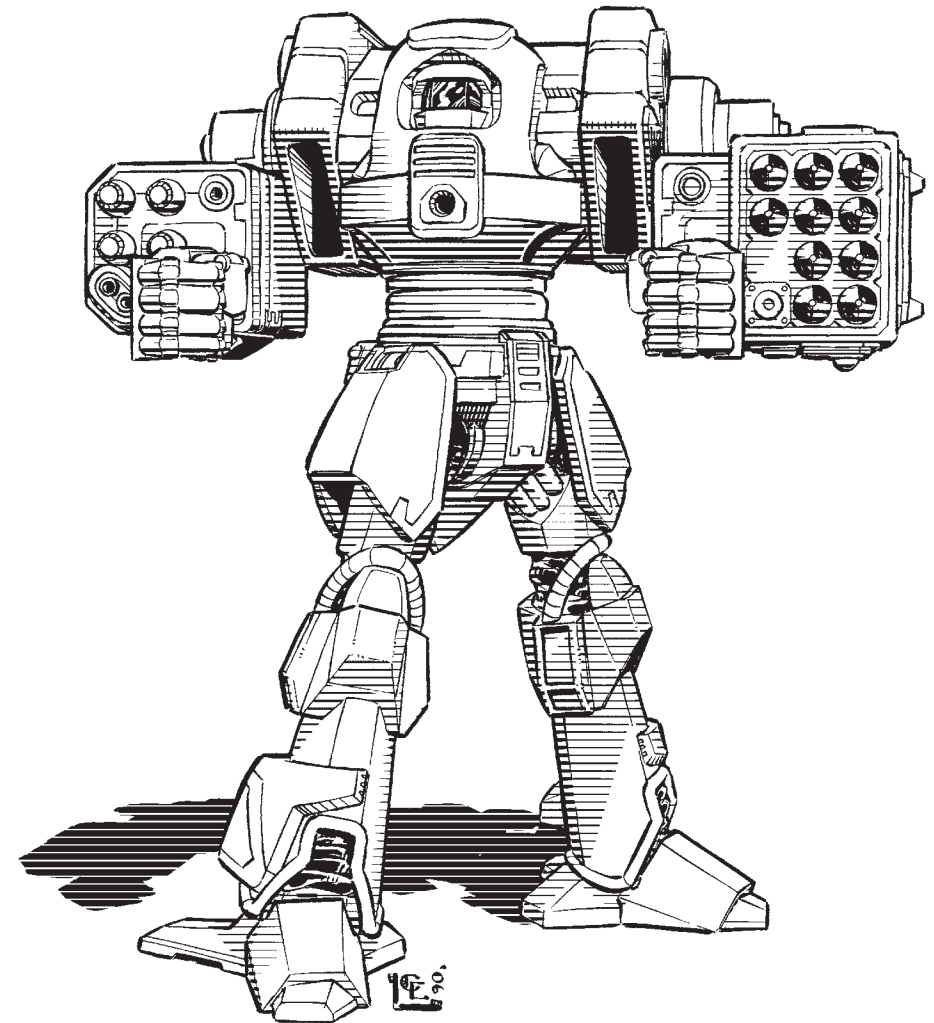



**Mass:** 30 tons  
**Chassis:** Process 12 Endo-steel  
**Power Plant:** Starfire 180 XL  
**Cruising Speed:** 64 kph  
**Maximum Speed:** 97 kph  
**Jump Jets:** None  
**Jump Capacity:** None  
**Armor:** Compound H18  
**Armament:**  
 16 tons of pod space available  
**Manufacturer:** Babylon MechWorks V (Cloud Cobra),  
 Production Line Gamma 2 (Snow Raven),  
 Ironhold Plant 9 (Jade Falcon)  
**Primary Factory:** Babylon, Lum, Ironhold  
**Communications System:** CobraTalk 12  
**Targeting and Tracking System:** Series XXX  
 MultiTrack

## Overview

Designated the *Uller* by Inner Sphere troops, the *Kit Fox* was designed by Clan Cloud Cobra to be a heavily armed light OmniMech. Among the Clans that invaded the Inner Sphere, only the Jade Falcons field the *Uller* in any number.

## Capabilities

Over half the *Uller's* mass is configurable, emphasizing pod space over speed or mobility. Common configurations are built around one or two long-range weapons supported by lighter lasers, missile racks, and other equipment.

The Primary and B configurations are centered on an autocannon backed by a missile launcher and lasers. Inexperienced warriors often cannot differentiate between the two. Configuration A was a nasty surprise for Inner

Sphere forces, who were not expecting a light 'Mech to be armed with a powerful Gauss rifle. Configuration D is a dedicated fire-support platform.

The C and S configurations were created for the return to the Inner Sphere. Rigged for city fighting, both are deadly opponents for conventional infantry.

The E, F, and H configurations represent attempts to integrate new weapon systems. The E mounts an ATM launcher, while the H is a derivative of the A that pairs heavy lasers with the powerful Gauss rifle. Like the H, the F is based on configuration A. Clan Hell's Horses have paired their new HAG 20 with two medium pulse lasers. With only two tons of ammunition, MechWarriors must take care not to squander their shots.

Configuration W is often used as a training 'Mech by Clan Wolf, Clan Wolf-in-Exile, and Wolf's Dragoons. Armed with pulse lasers, this configuration also mounts lower and hand actuators on the right arm.

## Deployment

Securing their access to the resources of the Tanite Worlds, the Cloud Cobras began new weapon programs. In 2890 the first of these programs bore fruit in the form of a new light OmniMech. Serving in Fang Clusters, the *Uller* soon netted the Cobras a string of victories against the Jade Falcons and Coyotes.

Taking note of the Cobras' success, Jade Falcon Khan Bret Malthus issued a challenge to fight a Trial of Possession for the design. Fought in the desolate wastelands on Babylon, the Falcons secured victory by the narrowest of margins. Taking their prize, the Falcons quickly made the *Uller* their standard light OmniMech.

Clan Snow Raven was also interested by the powerful *Uller*, but chose trade rather than conflict as a means of securing rights to manufacture the design. Clan Blood Spirit later received the *Uller* from the Ravens.

The *Uller* remains less common amongst the other Clans, who prefer speedier light OmniMechs. Those that do appear in their ranks are isorla taken from the battlefield.

## Notable MechWarriors

**Loremaster Eleni Riaz:** A young ristar and exceptional light-'Mech pilot, Eleni was plucked from the ranks of Gamma Galaxy to serve as aide to Khan Din Steiner. Winning a Riaz Bloodname, she was unanimously chosen to serve as Clan Cloud Cobra's Loremaster.

Type: **Kit Fox**

Inner Sphere Designation: **Uller**

Technology Base: Clan OmniMech

Tonnage: 30

Battle Value: 1,085

## Equipment

		Mass
Internal Structure:	Endo Steel	1.5
Engine:	180 XL	3.5
Walking MP:	6	
Running MP:	9	
Jumping MP:	0	
Heat Sinks:	10 [20]	0
Gyro:		2
Cockpit:		3
Armor Factor:	76	4
	<i>Internal Structure</i>	<i>Armor Value</i>
Head	3	9
Center Torso	10	9
Center Torso (rear)		4
R/L Torso	7	8
R/L Torso (rear)		4
R/L Arm	5	7
R/L Leg	7	8

## Weight and Space Allocation

Location	Fixed	Spaces Remaining
Head	1 Ferro-Fibrous	0
Center Torso	Double Heat Sink	0
Right Torso	2 XL Engine	5
	3 Endo Steel	
	2 Ferro-Fibrous	
Left Torso	2 XL Engine	2
	2 Double Heat Sinks	
	2 Endo Steel	
	2 Ferro-Fibrous	
Left Arm	1 Endo Steel	6
	1 Ferro-Fibrous	
Right Arm	1 Endo Steel	6
	1 Ferro-Fibrous	
Right Leg	None	2
Left Leg	None	2

## Weapons and Ammo Location Critical Tonnage

*Primary Weapons Configuration*

Streak SRM 4	RA	1	2
Ammo (Streak) 25	RA	1	1
LB 5-X AC	RA	4	7
Ammo (LB-X) 20	RA	1	1
ER Large Laser	LA	1	4
Small Pulse Laser	LA	1	1

**Weapons and Ammo Location Critical Tonnage**
*Alternate Configuration A*

Gauss Rifle	RA	6	12
Ammo (Gauss) 16	RA	2	2
2 ER Medium Lasers	LA	2	2
Battle Value: 1,310			

*Alternate Configuration B*

SRM 6	RA	1	1.5
Ammo (SRM) 15	RA	1	1
Ultra AC/10	RA	4	10
Ammo (Ultra) 20	RT	2	2
ER Medium Laser	LA	1	1
ER Small Laser	LA	1	.5
Battle Value: 1,088			

*Alternate Configuration C*

Active Probe	RA	1	1
TAG	RA	1	1
ECM Suite	RA	1	1
3 Anti-Missile Systems	RA	3	1.5
Ammo (AMS) 96	RT	4	4
ER Large Laser	LA	1	4
Small Pulse Laser	LA	1	1
2 Machine Guns	LA	2	.5
Ammo (MG) 200	LT	1	1
A-Pod	RL	1	.5
A-Pod	LL	1	.5
Battle Value: 1,150			

*Alternate Configuration D*

LRM 15	RA	2	3.5
Narc Missile Beacon	RA	1	2
Ammo (Narc) 6	RT	1	1
Ammo (LRM) 16	RT	2	2
LRM 15	LA	2	3.5
Ammo (LRM) 16	LA	2	2
LRM 5	LA	1	1
Ammo (LRM) 24	LT	1	1
Battle Value: 1,142			

*Alternate Configuration E*

ER PPC	RA	2	6
ER Small Laser	RA	1	.5
2 Double Heat Sinks	RA	4	2
Jump Jet	RT	1	.5
ATM 3	LA	2	1.5
Ammo (ATM) 60	LT	3	3
Jump Jet	LT	1	.5
Jump Jets	RL	2	1
Jump Jets	LL	2	1
Battle Value: 1,418			

**Weapons and Ammo Location Critical Tonnage**
*Alternate Configuration F*

HAG 20	RA	6	10
Ammo (HAG) 12	RA	2	2
2 Medium Pulse Lasers	LA	2	4
Battle Value: 1,219			

*Alternate Configuration H*

Gauss Rifle	RA	6	12
Ammo (Gauss) 16	RA	2	2
2 Heavy Medium Lasers	LA	4	2
Battle Value: 1,214			

*Alternate Configuration S*

Large Pulse Laser	RA	2	6
Small Pulse Laser	RA	1	1
Machine Gun	RT	1	.25
Ammo (MG) 100	RT	1	.5
Jump Jet	RT	1	.5
Medium Pulse Laser	LA	1	2
Streak SRM 4	LA	1	2
Ammo (Streak) 25	LA	1	1
Machine Gun	LT	1	.25
Jump Jet	LT	1	.5
Jump Jets	RL	2	1
Jump Jets	LL	2	1
Battle Value: 1,342			

**Weapons and Ammo Location Critical Tonnage**
*Alternate Configuration W*

Large Pulse Laser	RA	2	6
Medium Pulse Laser	RA	1	2
Large Pulse Laser	LA	2	6
Medium Pulse Laser	LA	1	2
Battle Value: 1,431			

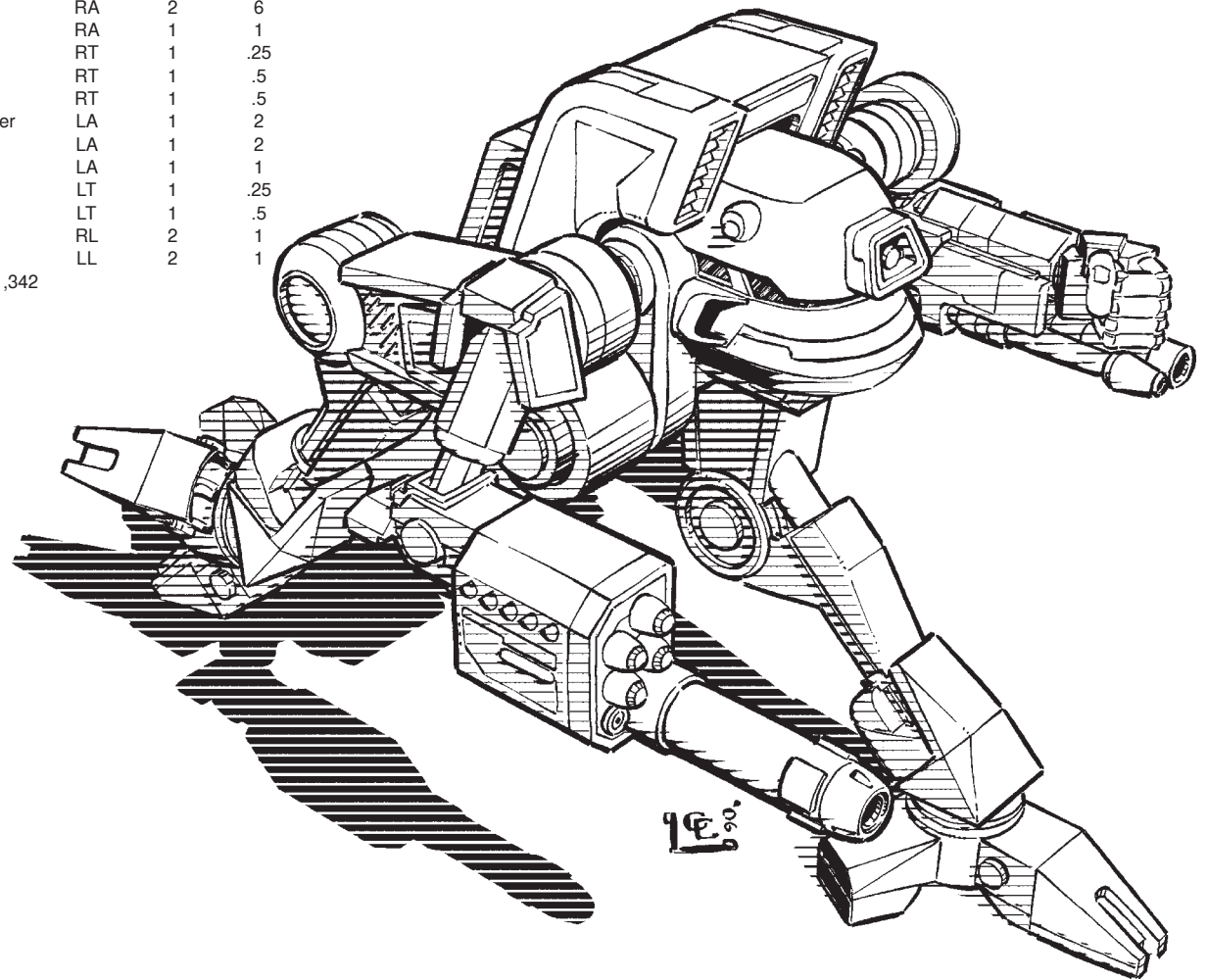



**Mass:** 35 tons

**Chassis:** Hooded Endo-Lite

**Power Plant:** Great Father 210 Extra-Light

**Cruising Speed:** 64 kph

**Maximum Speed:** 97 kph

**Jump Jets:** None

**Jump Capacity:** None

**Armor:** Star Lite Ferro-Fibrous

**Armament:**

- 1 DuPont Ultra PM Flamer
- 16 tons of pod space available

**Manufacturer:** Sheridan LM-TA 8-10, W-7 Facilities, Wolf Clan Site 3

**Primary Factory:** Sheridan (Sheridan), Tranquil (W-7), Arc-Royal (Site 3)

**Communications System:** Trueborn Ultra 945B

**Targeting and Tracking System:** Adder Special V8.6

## Overview

When the Dragoon Compromise delivered intelligence on the Inner Sphere to the Clans, the Star Adders realized how difficult it would be to conquer the Inner Sphere. Not only did they re-organize the second-line Kappa Galaxy to act as an Inner Sphere opposition force to train against, but they began to design an OmniMech that could emulate the majority of known Inner Sphere designs and defeat them in conflict. By 3010, the *Puma*—known as the *Adder* amongst the Clans—was being produced, and due to its success in many trials, many other Clans began declaring Trials of Possession for the design, spreading it widely by 3045.

The design succeeded brilliantly even through the Star Adders did not. The invasion of the Inner Sphere made it one of the most feared light BattleMechs of its time, swiftly carrying firepower that rivaled Inner Sphere BattleMechs twice its size.

## Capabilities

By far the most popular and feared configuration, the Primary configuration's pair of extended-ranged PPCs are tied to a targeting computer. This version is quickly being replaced within Crusader Clan ranks by the newer H version mounting a pair of heavy large lasers and extra heat sinks instead of the particle cannons.

Configurations A and C are typical fire-support version, though C was more intended for Kappa Galaxy with the Narc Beacon. The *Puma*'s B and D versions were in fact the original configurations based on Dragoon-sent intelligence, but they are rarely seen outside Kappa Galaxy, often when a unit is unsure of its opponent and needs a variety of choices.

A recently identified E configuration mounts a pair of ATM-9s and four micro pulse lasers, allowing MechWarriors to adapt to the changing battlefield needs. Even more recent is the designated J version reported by Phelan's Watch operatives as being deployed by the Hell's Horses on Paulus Prime. Mounting one of the newly developed hyper-assault Gauss rifles and a pair of light anti-personnel Gausses, this version is expected to perform excellently against Elementals and other conventional units.

## Deployment

The *Puma* is a popular design with many MechWarriors participating in Trials of Position or fighting for a Bloodname, pilots who value its impressive firepower and survivability on a lightweight chassis. Kappa galaxy uses the highest concentration within Clan Star Adder, odd since its designation lists it as a second-line Galaxy, but many other galaxies across Clan boundaries prize the *Puma* as well.

With production of the *Puma* restarted in 3066 on Arc-Royal, recently dispossessed Kell Hound MechWarriors have been issuing informal Trials for Possession of the design using training simulators, though only a handful have succeeded. Those that do often refit the design with Inner Sphere pods to reduce the maintenance requirements needed for such an advanced design.

## Notable MechWarriors

**Star Colonel Quenton:** Quenton is a freeborn warrior with an aptitude for night fighting and combat in low-visibility conditions. His gift for predicting enemy movements verges on the supernatural. Commanding the First Wolf Guardians, the Star Colonel is charged with defending Clan Wolf (in-Exile)'s stronghold on Arc-Royal.

Type: **Adder**

Inner Sphere Designation: **Puma**

Technology Base: Clan OmniMech

Tonnage: 35

Battle Value: 2,083

## Equipment

Equipment		Mass
Internal Structure:	Endo Steel	2
Engine:	210 XL	4.5
Walking MP:	6	
Running MP:	9	
Jumping MP:	0	
Heat Sinks:	10 [20]	0
Gyro:		3
Cockpit:		3
Armor Factor:	115	6
	<i>Internal Structure</i>	<i>Armor Value</i>
Head	3	9
Center Torso	11	16
Center Torso (rear)		6
R/L Torso	8	12
R/L Torso (rear)		4
R/L Arm	6	12
R/L Leg	8	14

## Weight and Space Allocation

Location	Fixed	Spaces Remaining
Head	1 Ferro-Fibrous	0
Center Torso	Flamer	0
	1 Endo Steel	
Right Torso	2 XL Engine	5
	Double Heat Sink	
	1 Endo Steel	
	2 Ferro-Fibrous	
Left Torso	2 XL Engine	5
	Double Heat Sink	
	1 Endo Steel	
	2 Ferro-Fibrous	
Left Arm	1 Ferro-Fibrous	7
Right Arm	1 Ferro-Fibrous	7
Right Leg	2 Endo Steel	0
Left Leg	2 Endo Steel	0

## Weapons and Ammo Location Critical Tonnage

*Primary Weapons Configuration*

Weapon	Location	Critical	Tonnage
ER PPC	RA	2	6
Targeting Computer	RT	3	3
ER PPC	LA	2	6
Double Heat Sink	LT	2	1



**Weapons and Ammo Location Critical Tonnage**
*Alternate Configuration A*

LRM 20	RA	4	5
Ammo (LRM) 12	RA	2	2
Small Pulse Laser	RT	1	1
LRM 20	LA	4	5
Ammo (LRM) 12	LA	2	2
Small Pulse Laser	LT	1	1
Battle Value: 1,437			

*Alternate Configuration B*

Large Pulse Laser	RA	2	6
ER Medium Laser	RT	1	1
LB 5-X AC	LA	4	7
Ammo (LB-X) 20	LA	1	1
ER Medium Laser	LT	1	1
Battle Value: 1,422			

*Alternate Configuration C*

LRM 15	RA	2	3.5
Ammo (LRM) 16	RA	2	2
Narc Missile Beacon	RT	1	2
Ammo (Narc) 6	RT	1	1
LRM 15	LA	2	3.5
Ammo (LRM) 16	LA	2	2
Medium Pulse Laser	LT	1	2
Battle Value: 1,372			

*Alternate Configuration D*

Ultra AC/5	RA	3	7
Ammo (Ultra) 20	RA	1	1
Streak SRM 2	RT	1	1
Ammo (Streak) 50	RT	1	1
ER Large Laser	LA	1	4
Streak SRM 2	LT	1	1
Ammo (Streak) 50	LT	1	1
Battle Value: 1,255			

*Alternate Configuration E*

ATM 9	RA	4	5
Ammo (ATM) 14	RA	2	2
2 Micro Pulse Lasers	RT	2	1
ATM 9	LA	4	5
Ammo (ATM) 14	LA	2	2
2 Micro Pulse Lasers	LT	2	1
Battle Value: 1,272			

*Alternate Configuration H*

2 Double Heat Sinks	RA	4	2
Heavy Large Laser	RA	3	4
Targeting Computer	RT	2	2
Double Heat Sink	RT	2	1
Heavy Large Laser	LA	3	4
Double Heat Sink	LA	2	1
2 Double Heat Sinks	LT	4	2
Battle Value: 1,453			

**Weapons and Ammo Location Critical Tonnage**
*Alternate Configuration J*

HAG 20	RA	6	10
Ammo (HAG) 18	RA	3	3
4 AP Gauss Rifles	LA	4	2
Ammo (APGauss) 40	LA	1	1
Battle Value: 1,222			

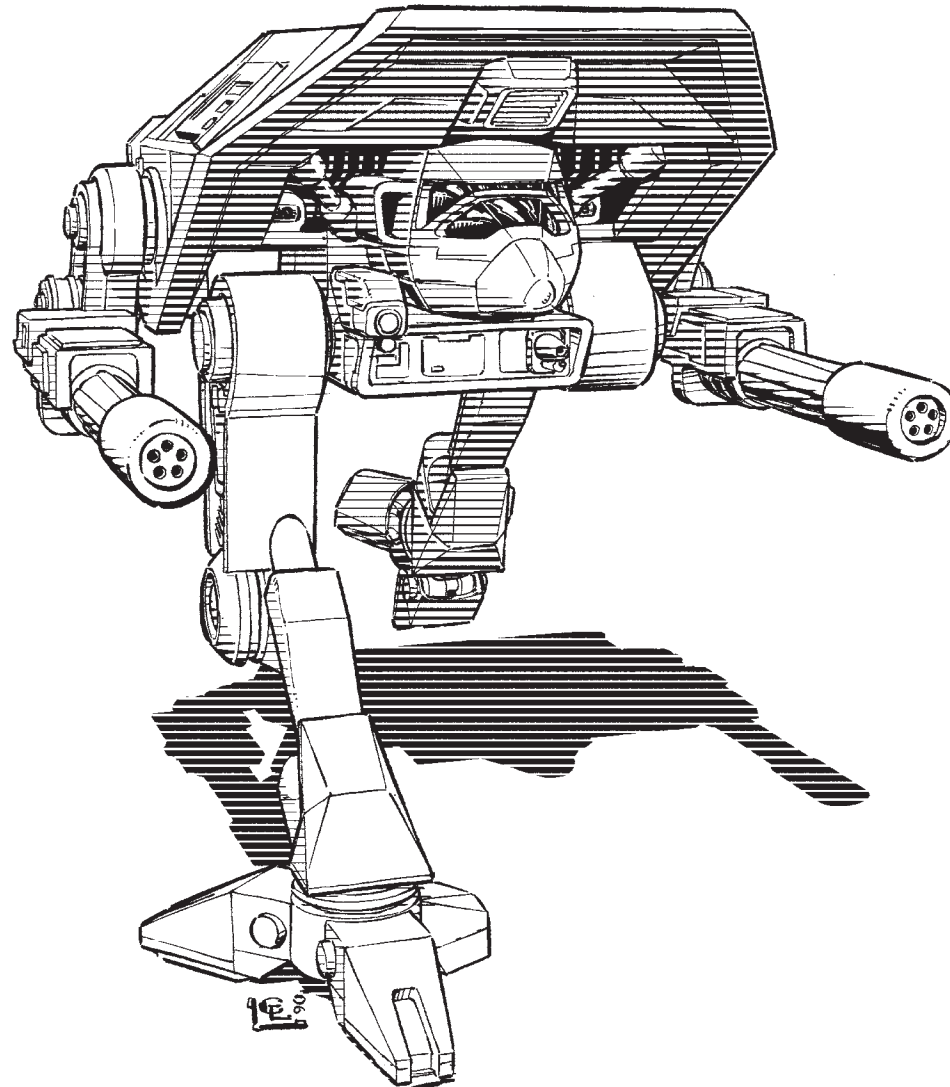

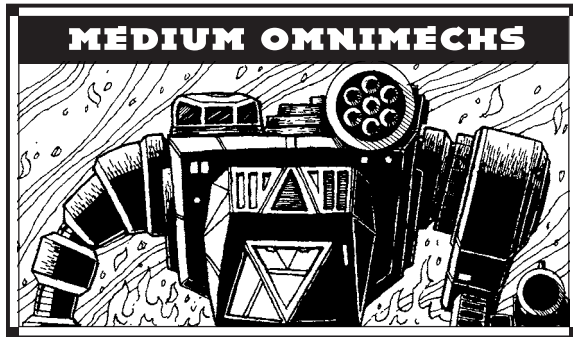

**Mass:** 40 tons

**Chassis:** Type W2 Endo-steel

**Power Plant:** 320 Light Force XL

**Cruising Speed:** 86 kph

**Maximum Speed:** 129 kph

**Jump Jets:** Geotec 300

**Jump Capacity:** 240 meters

**Armor:** Compound H17 Ferro-Fibrous

**Armament:**

8.5 tons of pod space available

**Manufacturer:** Upsilon Plant 2J

**Primary Factory:** Strana Mechty

**Communications System:** Series D8 CC-25X

**Targeting and Tracking System:** Sloane 220

Lockover System

## Overview

One of Clan Fire Mandrill's first attempts at OmniMech design yielded a superbly mobile yet decidedly under-armed 'Mech known as the *Viper*, or *Dragonfly* in the Inner Sphere. Conceived as a quick-strike unit, the design ultimately fell out of favor with several of the kindraa due to major problems with the omnipod mechanisms. In 3002, the Mandrills gave the Ghost Bears all design specifications and their main manufacturing facility on Shadow in return for several production runs of their *Gladiator* platform. Unwilling to keep a small enclave in the middle of warring kindraa, the Ghost Bears dismantled the plant and moved it to Strana Mechty. In the process, the Bears developed a modular construction system that ultimately allowed them to move several other factories during their exodus to the Inner Sphere decades later.

## Capabilities

Fast and maneuverable, the *Dragonfly* enjoyed some success amongst Ghost Bear forces as a complimentary platform to the *Dasher*. Utilizing a heavier mix of shorter-ranged weapons among many of the configurations, the *Dragonfly* was considered a failure when used in Clan engagements and during their subsequent invasion of the Inner Sphere. It was not until the Combine-Ghost Bear war that the design saw resurgence in use, thanks to a heavier emphasis on a more combined-arms approach with battle armor and 'Mechs.

Three new configurations have appeared among those Clans who utilize such a doctrine. The Horses use a configuration that employs heavy machine gun arrays and lasers; the Bears field the G configuration that mounts the new AP Gauss rifle system and plasma cannon; and the Hellions trialed for the rights to the Strana Mechty facility to produce a heavy laser configuration that utilizes a targeting computer and a small ATM system.

## Deployment

Produced in large numbers before the Clan invasion, *Dragonflies* are common among many Ghost Bear forces. Few other Clans utilize the OmniMech, preferring to field more capable units such as the *Shadow Cat* and *Grendel*. In the mid-60s, the Horses trialed for (and won) production rights in order to design a new support platform. Surprisingly, the Hellions followed suit shortly thereafter, winning the entire Strana Mechty plant after a grueling twelve hour battle between both saKhans in early 3068. The Hellions put the facility to immediate use—their new configuration is shipped off as soon as DropShips can be loaded—and lends firm evidence to rumors that the Hellions are planning a large-scale operation, most likely against their Coyote neighbors on Foster.

## Notable MechWarriors

**Star Captain Toris Fletcher:** A ristar among the Horses, Fletcher is admired by many of the Horses' Elementals due to his reckless devotion to all members of his binary. Known for rescuing three Horse troopers from a burning hanger while in the midst of a duel with a Bear Nova, he has refused several suggestions by his commanders to try for command of his Trinary. His *Dragonfly* is easily recognizable by its purple paint scheme, a concession his Galaxy Commander has allowed him due to his tremendous codex.

Type: **Viper**

Inner Sphere Designation: **Dragonfly**

Technology Base: Clan OmniMech

Tonnage: 40

Battle Value: 1,450

## Equipment

		Mass
Internal Structure:	Endo Steel	2
Engine:	320 XL	11.5
Walking MP:	8	
Running MP:	12	
Jumping MP:	8	
Heat Sinks:	10 [20]	0
Gyro:		4
Cockpit:		3
Armor Factor:	134	7
	<i>Internal Structure</i>	<i>Armor Value</i>
Head	3	9
Center Torso	12	16
Center Torso (rear)		7
R/L Torso	10	13
R/L Torso (rear)		7
R/L Arm	6	12
R/L Leg	10	19

## Weight and Space Allocation

Location	Fixed	Spaces Remaining
Head	1 Ferro-Fibrous	0
Center Torso	1 Endo Steel	1
Right Torso	2 Engine	
	1 Ferro-Fibrous	
	3 Endo Steel	
	2 Jump Jets	4
Left Torso	2 Engine	
	1 Ferro-Fibrous	
	3 Endo Steel	
	2 Jump Jets	4
Left Arm	2 Ferro-Fibrous	6
Right Arm	2 Ferro-Fibrous	6
Right Leg	2 Jump Jets	0
Left Leg	2 Jump Jets	0

## Weapons and Ammo

### Primary Weapons Configuration

Location	Critical	Tonnage
2 Medium Pulse Lasers	2	4
2 Machine Guns	2	.5
Ammo (MG) 100	1	.5
SRM 4	1	1
Ammo (SRM) 25	1	1
Anti-Missile System	1	.5
Ammo (AMS) 24	1	1

**Weapons and Ammo Location Critical Tonnage**

*Alternate Configuration A*

ER Medium Laser	RA	1	1
2 ER Medium Lasers	RT	2	2
SRM 6	LA	1	1.5
Ammo (SRM) 15	LA	1	1
Artemis IV FCS	LA	1	1
2 ER Medium Lasers	LT	2	2
Battle Value: 2,004			

*Alternate Configuration B*

Small Pulse Laser	RA	1	1
Flamer	RT	1	.5
ER PPC	LA	2	6
Small Pulse Laser	LT	1	1
Battle Value: 1,830			

*Alternate Configuration C*

Ammo (MG) 200	RA	1	1
2 Flamers	RT	2	1
2 Machine Guns	RT	2	.5
2 ER Medium Lasers	LA	2	2
Active Probe	LA	1	1
2 Machine Guns	LT	2	.5
Ammo (MG) 400	LT	2	2
Flamer	CT	1	.5
Battle Value: 1,356			

*Alternate Configuration D*

2 ER Medium Lasers	RA	2	2
LRM 5	RT	1	1
Ammo (LRM) 24	RT	1	1
Streak SRM 6	LA	2	3
Ammo (Streak) 15	LA	1	1
ER Small Laser	LT	1	.5
Battle Value: 1,779			

*Alternate Configuration E*

ER Medium Laser	RA	1	1
ER Small Laser	RT	1	.5
ATM 6	LA	3	3.5
Ammo (ATM) 30	LA	3	3
ER Small Laser	LT	1	.5
Battle Value: 1,561			

*Alternate Configuration F*

4 Heavy Machine Guns	RA	4	2
Machine Gun Array	RA	1	.25
Ammo (Heavy MG) 100	RA	1	1
ER Medium Laser	RT	1	1
4 Heavy Machine Guns	LA	4	2
Machine Gun Array	LA	1	.25
ER Medium Laser	LT	1	1
ER Medium Laser	CT	1	1
Battle Value: 1,574			

**Weapons and Ammo Location Critical Tonnage**

*Alternate Configuration G*

4 AP Gauss Rifle	RA	4	2
Ammo (APGauss) 40	RA	1	1
Plasma Cannon	LA	1	3
Ammo (Plasma) 10	LA	1	1
Heavy Medium Laser	LT	2	1
Light Active Probe	CT	1	.5
Battle Value: 1,574			

*Alternate Configuration H*

Heavy Medium Laser	RA	2	1
ER Medium Laser	RT	1	1
Small Pulse Laser	RT	1	1
Double Heat Sink	RT	2	1
Heavy Medium Laser	LA	2	1
Anti-Missile System	LT	1	.5
Ammo (AMS) 24	LT	1	1
ER Medium Laser	LT	1	1
Small Pulse Laser	LT	1	1
Battle Value: 1,732			

**Weapons and Ammo Location Critical Tonnage**

*Alternate Configuration I*

Heavy Medium Laser	RA	2	1
Heavy Medium Laser	RT	2	1
Light Active Probe	RT	1	.5
Targeting Computer	RT	1	1
Heavy Medium Laser	LA	2	1
ATM 3	LA	2	1.5
Ammo (ATM) 20	LA	1	1
Anti-Missile System	LT	1	.5
Ammo (AMS) 24	LT	1	1
Battle Value: 1,587			

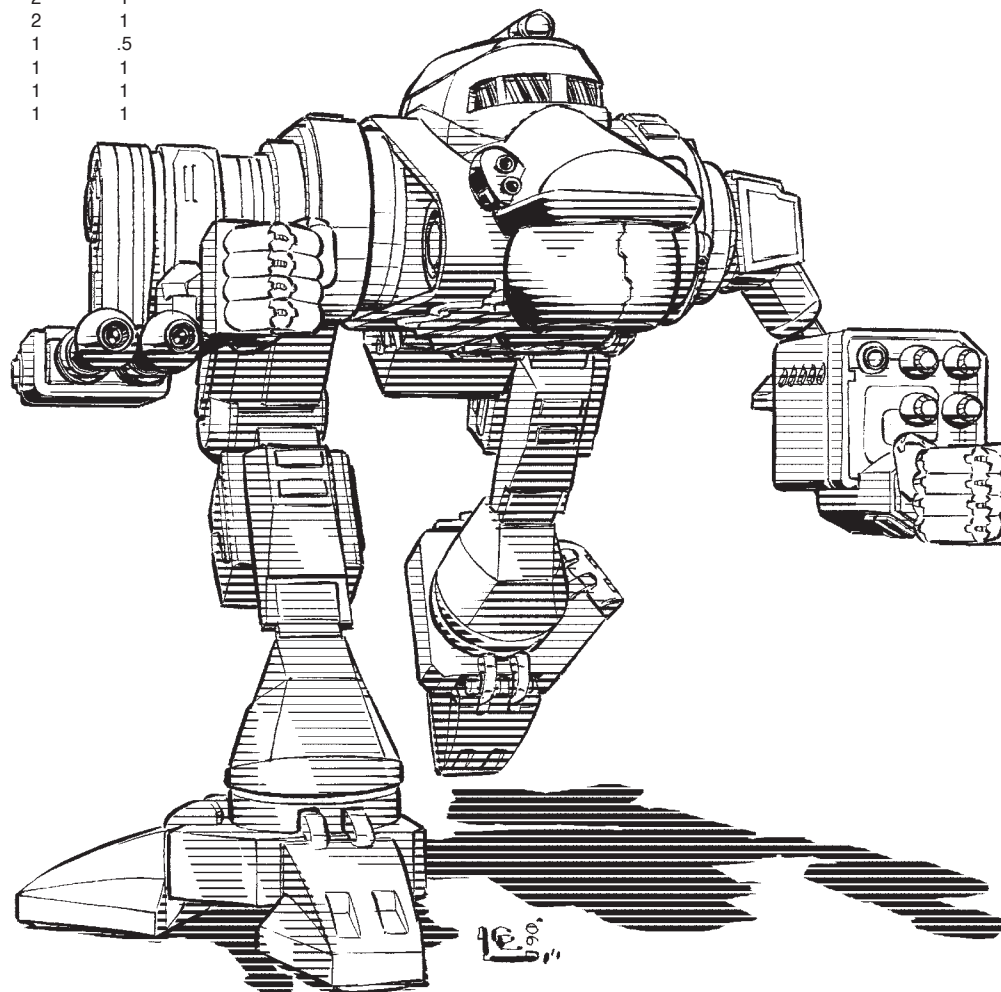

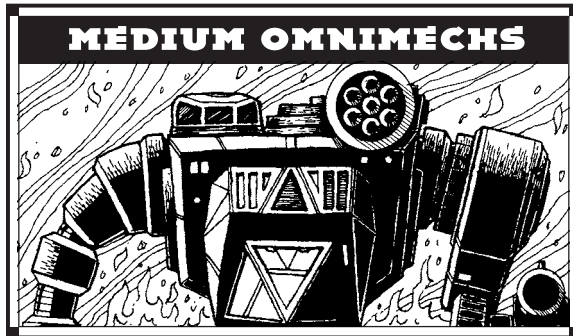

**Mass:** 45 tons  
**Chassis:** Hellion Medium Gamma ES  
**Power Plant:** 360 Type II XL  
**Cruising Speed:** 86 kph  
**Maximum Speed:** 129 kph  
**Jump Jets:** None  
**Jump Capacity:** None  
**Armor:** MAC Level 5 Ferro-Fibrous  
**Armament:**  
 9.5 tons of pod space available  
**Manufacturer:** W-7 Facilities, Wolf Clan Site 3  
**Primary Factory:** Tranquil, Arc-Royal  
**Communications System:** Hellion Special 354B  
**Targeting and Tracking System:** Wolf Hunter MK VII

## Overview

The *Ice Ferret*—or *Fenris* as it is known to the Inner Sphere—is the most heavily used medium OmniMech of the Wolf Touman. Ironically it was supposed to be the Ice Hellion's answer to Clan Wolf's newly debuted *Timber Wolf* heavy OmniMech. Emphasizing speed and firepower, the Clan's typical traits, many of their warriors boasted that they would de-claw the mighty Wolves, producing the then-named *Wolf Hunter* as fast as they could since 2948.

Tired of the constant harassment, many Wolf units began challenging Ice Hellions for possession of their *Wolf Hunters*. The next five years saw the Ice Hellions lose eighty percent of their *Wolf Hunters*, including their production facility on Tranquil to the Wolves. The Wolves renamed the OmniMech the *Ice Ferret* after the Hellion's sole natural predator. The campaign soured the other Clans from desiring the OmniMech, as it had lost so many trials, but the Wolves instead created a slew of new configurations for it

and spread it through its ranks, where it became a highly valued reconnaissance and support design.

## Capabilities

Many of the *Fenris* configurations revolve on a single, long-range weapon as the primary gun backed up by several smaller short-range batteries. This gives MechWarriors a distinct advantage from other speed-centered designs that typically utilize a slew of light short-range weapons. Few versions differ, mainly the long-range fire-support C configuration and the more traditional D version mounting four medium pulse lasers.

Newer versions seen in the past decade have been gaining popularity. The Wolves (in-Exile) mount an advanced missile rack as the *Fenris*' main weapon, while Khan Ward's configuration uses a pair of heavy medium lasers as secondary weapons in his Clan's H configuration. The newest L version utilizes the latest acquired technology by Phelan's Wolves, mounting a plasma cannon and a trio of light anti-personnel Gausses tied to a targeting computer. Used to fight against the rising use of non-BattleMech forces, the Crusader Wolves have copied this configuration for use in their home territories when expecting to fight ProtoMechs and Elemental heavy forces.

## Deployment

Due to the stigma early on in the design's life span due to the string of losses, only the Wolves have deployed the *Fenris* in any large numbers during the invasion. The Hellions still have the next highest amount, but even those are limited to the number that survived the embarrassing streak of losses. Many of those are often spotted in clusters piloted by bitter warriors who seem driven to reclaim the design's lost heritage and who refuse to use anything but its original name.

## Notable MechWarriors

**Star Commander Sperling:** This Clan Wolf trueborn has a generally average record other than managing to survive the past fifteen tumultuous years in frontline galaxies as a light OmniMech pilot. His favorite drinking story, though, is how he claimed his current *Fenris* as *Isorla* from a preening Ice Hellion using only a *Dasher*-Primary.

Type: **Ice Ferret**

Inner Sphere Designation: **Fenris**

Technology Base: Clan OmniMech

Tonnage: 45

Battle Value: 1,684

Equipment		Mass
Internal Structure:	Endo Steel	2.5
Engine:	360 XL	16.5
Walking MP:	8	
Running MP:	12	
Jumping MP:	0	
Heat Sinks:	12 [24]	2
Gyro:		4
Cockpit:		3
Armor Factor:	144	7.5
	<i>Internal Structure</i>	<i>Armor Value</i>
Head	3	9
Center Torso	14	19
Center Torso (rear)		8
R/L Torso	11	14
R/L Torso (rear)		7
R/L Arm	7	14
R/L Leg	11	19

## Weight and Space Allocation

Location	Fixed	Spaces Remaining
Head	1 Ferro-Fibrous	0
Center Torso	1 Endo Steel	1
Right Torso	2 Engine 2 Ferro-Fibrous	7
Left Torso	1 Endo Steel 2 Engine 2 Ferro-Fibrous	7
Left Arm	1 Ferro-Fibrous	7
Right Arm	1 Ferro-Fibrous	7
Right Leg	2 Endo Steel	0
Left Leg	2 Endo Steel	0

## Weapons and Ammo Location Critical Tonnage

### Primary Weapons Configuration

Location	Critical	Tonnage
Streak SRM 2	1	1
Ammo (Streak)	1	1
ER PPC	2	6
ER Small Laser	1	.5
Active Probe	1	1

### Alternate Configuration A

Location	Critical	Tonnage
ER Medium Laser	1	1
Anti-Missile System	1	.5
Ammo (AMS) 24	1	1
LB 2-X AC	4	6
Ammo (LB-X) 45	1	1
ER Medium Laser	1	1

Battle Value: 1,323

**Weapons and Ammo Location Critical Tonnage**

*Alternate Configuration B*

SRM 6	RA	1	1.5
Ammo (SRM) 15	RA	1	1
SRM 4	LA	1	1
Ammo (SRM) 25	LA	1	1
ER Large Laser	LA	1	4
Small Pulse Laser	CT	1	1
Battle Value: 1,461			

*Alternate Configuration C*

LRM 5	RA	1	1
Artemis IV FCS	RA	1	1
Ammo (LRM) 24	RA	1	1
LRM 5	LA	1	1
Artemis IV FCS	LA	1	1
Ammo (LRM) 24	LA	1	1
LRM 5	LT	1	1
Artemis IV FCS	LT	1	1
Ammo (LRM) 24	LT	1	1
ER Small Laser	CT	1	.5
Battle Value: 1,211			

*Alternate Configuration D*

2 Medium Pulse Lasers	RA	2	4
Anti-Missile System	LA	1	.5
Ammo (AMS) 24	LA	1	1
Medium Pulse Laser	LA	1	2
Medium Pulse Laser	CT	1	2
Battle Value: 1,653			

*Alternate Configuration E*

ER Medium Laser	RA	1	1
ER Small Laser	RA	1	.5
ATM 9	LA	4	5
Ammo (ATM) 21	LA	3	3
Battle Value: 1,483			

*Alternate Configuration H*

2 Heavy Medium Lasers	RA	4	2
Double Heat Sink	RT	2	1
ER Large Laser	LA	1	4
SRM 6	LA	1	1.5
Ammo (SRM) 15	LA	1	1
Battle Value: 1,619			

*Alternate Configuration L*

Plasma Cannon	RA	1	3
Ammo (Plasma) 20	RA	2	2
3 AP Gauss Rifles	LA	6	1.5
Ammo (APGauss) 80	LA	2	2
Targeting Computer	CT	1	1
Battle Value: 1,380			

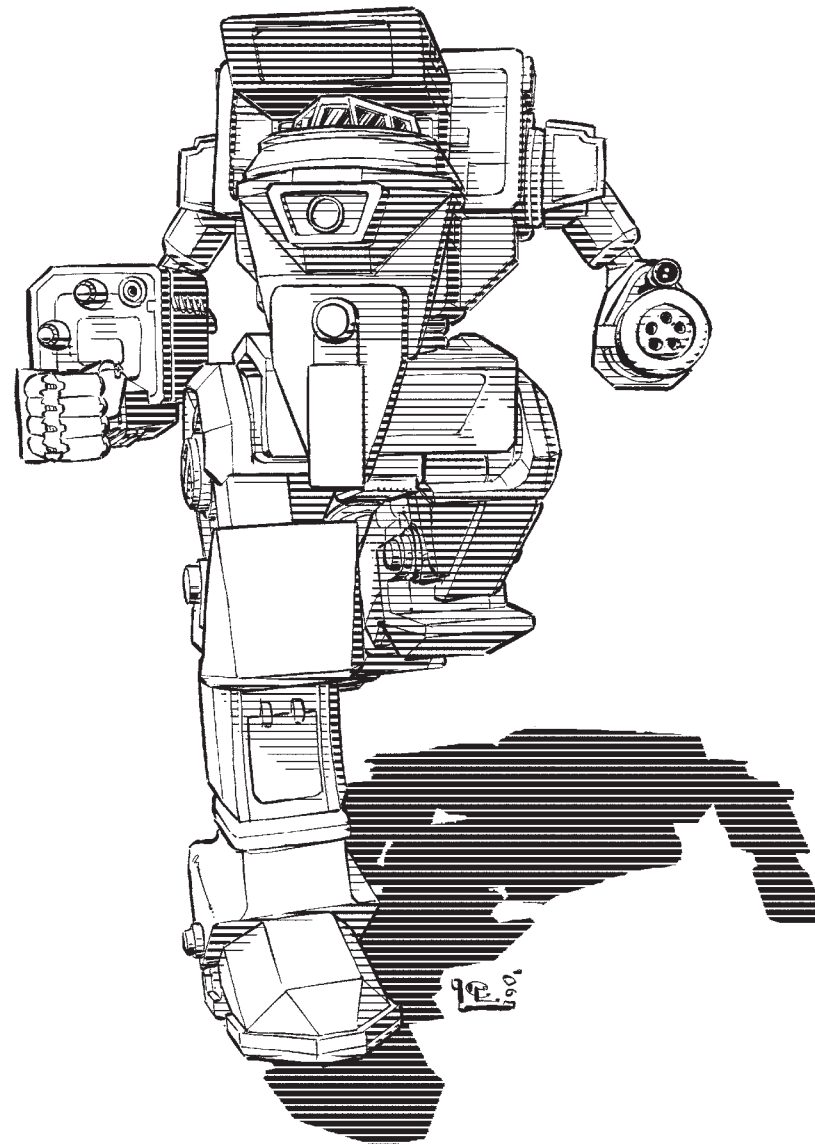

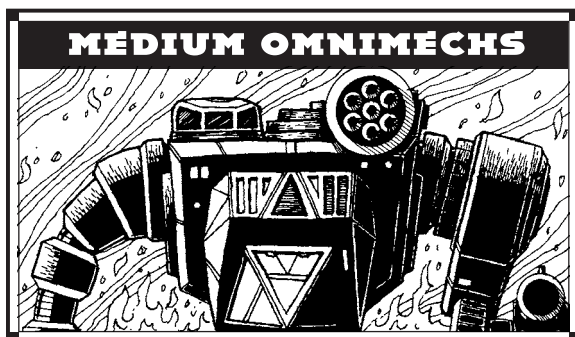

**Mass:** 50 tons  
**Chassis:** Star League XTA  
**Power Plant:** 250 XL Model SF-2  
**Cruising Speed:** 54 kph  
**Maximum Speed:** 86 kph  
**Jump Jets:** Clan Standard Type A2  
**Jump Capacity:** 150 meters  
**Armor:** Forge Type HH30  
**Armament:**  
 16 tons of pod space available  
**Manufacturer:** Tokasha MechWorks  
**Primary Factory:** Tokasha  
**Communications System:** CH3B  
**Targeting and Tracking System:** Version Omega-V TTS

## Overview

Clan Coyote introduced the first OmniMech in 2854, but it was not until 2870 that Clan Hell's Horses produced their first homegrown OmniMech design. Dubbed the *Black Hawk* by the Inner Sphere, the *Nova* was manufactured at the Tokasha MechWorks until 2921. When the Ghost Bears captured the plant they discontinued production.

## Capabilities

The design of the *Black Hawk* was based loosely on the *Supernova*, but the Hell's Horses streamlined production of their first OmniMech, and they avoided bulky material for the chassis or armor. The *Black Hawk's* other equipment, such as the jump jets, is integral to the base chassis. Although this decision gives the *Black Hawk* more internal space, which simplifies the task of reconfiguring the pods, it also means that pod weight is limited to sixteen tons.

The most innovative feature of the *Black Hawk* was the introduction of special connection points that allowed

the Hell's Horses new battle armor-equipped troops to operate as mechanized battle armor. This concept proved so successful that it became standard on all OmniMechs.

The primary configuration is armed with a staggering battery of medium lasers. Even an additional four pod heat sinks cannot handle the heat these weapons generate. Configuration A has a far better balanced mix and is a very common configuration. The weaknesses of the *Black Hawk's* design are clear in the B and C configurations. Armed with heavy ballistic weapons, there is little mass left to add supporting weapons. Derived from the primary configuration, the S has been reconfigured for urban warfare.

Like other OmniMechs, the *Black Hawk* can be easily adapted to mount new weapons. Clan Coyote has introduced the E type. Although armed with a powerful ATM-9 launcher, the basic weakness of the chassis can once again be seen in the paltry secondary armament. The Star Adders' H configuration showcases their heavy medium lasers. Meanwhile, the Hell's Horses are using their remaining *Black Hawks* as a testbed for their HAG 20.

## Deployment

The *Black Hawk* made its battlefield debut during the assault on Kindraa Smythe-Jewel on Foster. The Hell's Horses new mechanized battle armor tactics proved devastating against the ill-prepared Fire Mandrills.

A jack of all trades, the *Black Hawk* has been relegated to play a secondary role to heavier and lighter OmniMechs. No longer in production, numbers have diminished steadily, and the remaining chassis is now spread relatively evenly throughout the Clans.

## Notable MechWarriors

**Star Colonel Diana Pryde:** Freeborn daughter of the legendary Aidan Pryde, Diana has not only become a Jade Falcon warrior, but has also won a Bloodname—a feat only one other freeborn has ever achieved. Her defeat of Steel Viper Khan Perigard Zalman in 3061 broke the back of the Viper assault on the Falcon's Inner Sphere holdings, vindicating Khan Marthe Pryde's decision to allow a freebirth to compete for a Bloodname.

Elevated to Star Colonel, Diana was tasked with rebuilding the Falcon Guards after the Cluster was destroyed for a second time. Her new command has performed well in the renewed drive into Lyran territory.

Type: **Nova**  
 Inner Sphere Designation: **Black Hawk**  
 Technology Base: Clan OmniMech  
 Tonnage: 50  
 Battle Value: 2,663

Equipment		Mass
Internal Structure:		5
Engine:	250 XL	6.5
Walking MP:	5	
Running MP:	8	
Jumping MP:	5	
Heat Sinks:	14 [28]	4
Gyro:		3
Cockpit:		3
Armor Factor:	160	10
	<i>Internal Structure</i>	<i>Armor Value</i>
Head	3	9
Center Torso	16	23
Center Torso (rear)		8
R/L Torso	12	18
R/L Torso (rear)		8
R/L Arm	8	16
R/L Leg	12	20

## Weight and Space Allocation

Location	Fixed	Spaces Remaining
Head		1
Center Torso	1 Jump Jet	1
Right Torso	2 XL Engine	6
	2 Double Heat Sinks	
Left Torso	2 XL Engine	6
	2 Double Heat Sinks	
Left Arm	None	8
Right Arm	None	8
Right Leg	2 Jump Jets	0
Left Leg	2 Jump Jets	0

## Weapons and Ammo Location Critical Tonnage

### Primary Weapons Configuration

Weapon	Location	Critical	Tonnage
6 ER Medium Lasers	RA	6	6
Double Heat Sink	RA	2	1
Double Heat Sink	RT	2	1
6 ER Medium Lasers	LA	6	6
Double Heat Sink	LA	2	1
Double Heat Sink	LT	2	1

### Alternate Configuration A

Weapon	Location	Critical	Tonnage
ER PPC	RA	2	6
Anti-Missile System	RT	1	.5
Ammo (AMS) 24	RT	1	1
ER PPC	LA	2	6
Medium Pulse Laser	LT	1	2
Anti-Missile System	LT	1	.5

Battle Value: 2,422

**Weapons and Ammo Location Critical Tonnage**

*Alternate Configuration B*

Ultra AC/5	RA	3	7
Ammo (Ultra) 20	RA	1	1
ER Small Laser	RT	1	.5
Large Pulse Laser	LA	2	6
2 Machine Guns	LT	2	.5
Ammo (MG) 200	LT	1	1
Battle Value: 1,543			

*Alternate Configuration C*

Small Pulse Laser	RT	1	1
Gauss Rifle	LA	6	12
Ammo (Gauss) 8	LA	1	1
SRM 4	LT	1	1
Ammo (SRM) 25	LT	1	1
Battle Value: 1,515			

*Alternate Configuration D*

LRM 20	RA	4	5
Ammo (LRM) 12	RA	2	2
LB 5-X AC	LA	4	7
Ammo (LB-X) 40	LA	2	2
Battle Value: 1,450			

*Alternate Configuration E*

ATM 12	RA	7	5
Ammo (ATM) 30	RT	6	6
3 ER Medium Lasers	LA	3	3
Battle Value: 2,078			

*Alternate Configuration F*

HAG 20	RA	6	10
Ammo (HAG) 18	RA	3	3
3 ER Medium Lasers	LA	3	3
Battle Value: 1,976			

*Alternate Configuration H*

5 Heavy Medium Lasers	RA	10	5
3 Double Heat Sinks	RT	6	3
5 Heavy Medium Lasers	LA	10	5
3 Double Heat Sinks	LT	6	3
Battle Value: 1,832			

*Alternate Configuration S*

3 Medium Pulse Lasers	RA	3	6
Ammo (AMS) 24	RT	1	1
2 Machine Guns	RT	2	.5
3 Medium Pulse Lasers	LA	3	6
2 Machine Guns	LT	2	.5
Ammo (MG) 100	LT	1	.5
Active Probe	H	1	1
Anti-Missile System	CT	1	.5
Battle Value: 2,061			

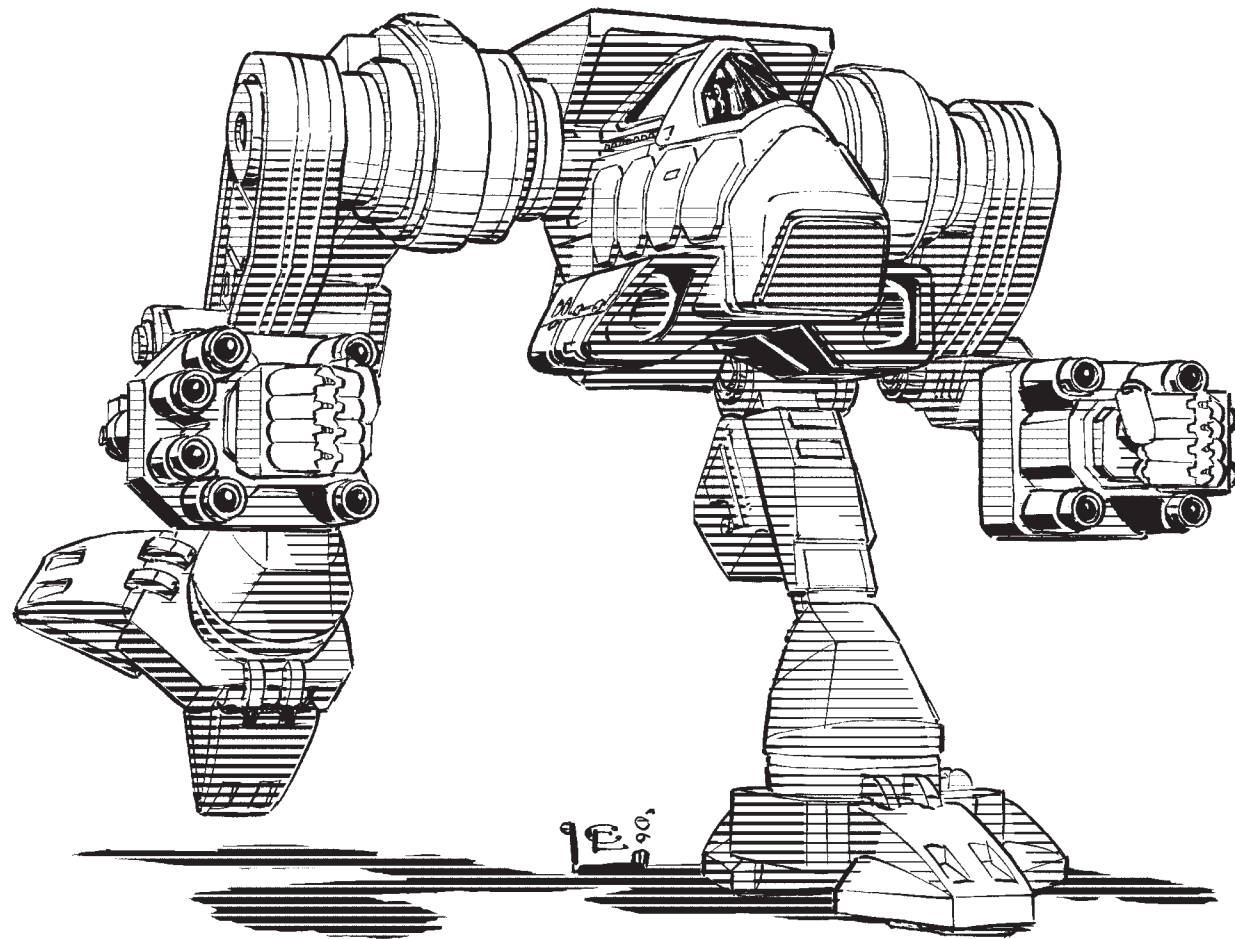

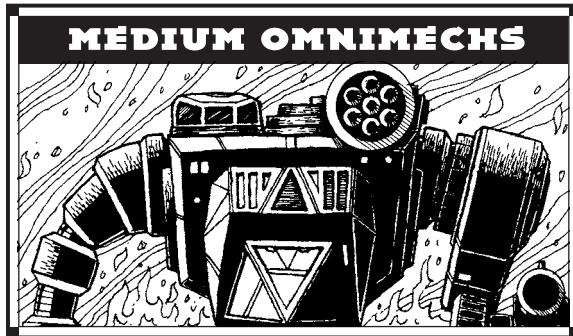

**Mass:** 55 tons  
**Chassis:** Model MHO-7E Endo-Steel  
**Power Plant:** Fusion 330 Extralight  
**Cruising Speed:** 64 kph  
**Maximum Speed:** 97 kph  
**Jump Jets:** None  
**Jump Capacity:** None  
**Armor:** Compound H17/2 Ferro-Fibrous  
**Armament:**  
 23 tons of pod space available  
**Manufacturer:** Various  
**Primary Factory:** Various  
**Communications System:** GBX Series Integrated  
**Targeting and Tracking System:** Tokasha B4-T&T

## Overview

A sleek, mobile, and versatile design, the Clan *Stormcrow* (designated the *Ryoken* by the DCMS troops who first encountered it during the Clan Invasion) was long suspected to be one of the first OmniMechs produced by the Clans. More recent data—particularly the discovery of Clan Hell’s Horses’ venerable *Corvis* design—points to a later development, however, post-dating the first Omnis by roughly fifty years. Indeed, some historical records say the *Ryoken* debuted about the time of the infamous Horses-Ghost Bear Battle for Tokasha, in which prototypes of the so-called “*Omni-Corvis*” first saw action.

## Capabilities

Incorporating the best in weight-saving technologies, the *Ryoken* has excellent overland speed and near-maximum armor levels for its weight. With over twenty tons of pod space available, most configurations take advantage of the strong armor and speed to focus on load-outs

that maximize this Omni’s performance as both a duelist and a hunter/killer. Of the initial five configurations, only the D focused more on missile support, providing a profile distinctly different than the usual laser-and-autocannon mixes seen in the Primary, A, and C configurations.

Of the more modern alternate payloads, the E—favored by the Coyotes and other Warden Clans—uses the more recently produced ATM system for greater fire support flexibility, while the H demonstrates the devastating potential of heavy lasers. The F configuration, first witnessed among the Jade Falcon touman, uses a mix of newly debuted plasma cannons and anti-personnel Gauss weaponry to perform extensive anti-vehicle or anti-infantry work. Meanwhile, the Hell’s Horses’ new G configuration sports a powerful hyper-assault Gauss backed up by a five-pack of medium lasers—a combination that has proven its worth against numerous Wolf Clan targets since the Horses’ return to the Inner Sphere.

## Deployment

The fall of the Tokasha MechWorks of Clan Ghost Bear in 2921 apparently resulted in the scattering of the early pre-*Ryoken* prototypes to other Clans. Interestingly enough, it was the Snow Ravens—despite their greater emphasis on aerospace forces—who fielded the finalized version of this so-called “second generation Omni” by about 2930, drawing on technical schematics and components obtained in their trade with the Ghost Bears. Since then, the solid performance of the *Ryoken* has assured this ‘Mech a place in every Clan’s touman, with numerous factories scattered throughout the homeworlds.

## Notable MechWarriors

**Star Colonel (Loremaster) Temuchin Amirault:** Earning his Bloodname shortly before his rise to Clan Loremaster and head of the Horses’ Watch, Star Colonel Temuchin Amirault was considered a ristar during the (literally) iron-fisted Khanship of Malavai Fletcher. Even though his political views remain a guarded secret, his devotion to Fletcher’s campaign had many questioning why he was retained as Loremaster after the ascent of Khan James Cobb. The appearance of his *Ryoken*, solid black except for the flaming gold numeral “1” on its left forearm, was the last thing ever seen by numerous garrison warriors and backwater pirates when the Horses’ early forays against Clan Wolf began in 3068.

Type: **Stormcrow**  
 Inner Sphere Designation: **Ryoken**  
 Technology Base: Clan OmniMech  
 Tonnage: 55  
 Battle Value: 2,073

Equipment		Mass
Internal Structure:	Endo Steel	3
Engine:	330 XL	12.5
Walking MP:	6	
Running MP:	9	
Jumping MP:	0	
Heat Sinks:	10 [20]	0
Gyro:		4
Cockpit:		3
Armor Factor:	182	9.5
	<i>Internal Structure</i>	<i>Armor Value</i>
Head	3	9
Center Torso	18	25
Center Torso (rear)		10
R/L Torso	13	17
R/L Torso (rear)		9
R/L Arm	9	18
R/L Leg	13	25

## Weight and Space Allocation

Location	Fixed	Spaces Remaining
Head	None	1
Center Torso	1 Endo Steel	0
	1 Ferro-Fibrous	
Right Torso	2 XL Engine	6
	1 Endo Steel	
	3 Ferro-Fibrous	
Left Torso	2 XL Engine	6
	1 Endo Steel	
	3 Ferro-Fibrous	
Left Arm	None	8
Right Arm	None	8
Right Leg	2 Endo Steel	0
Left Leg	2 Endo Steel	0

## Weapons and Ammo Location Critical Tonnage

Primary Weapons Configuration			
ER Large Laser	RA	1	4
ER Medium Laser	RA	1	1
3 Double Heat Sinks	RA	6	3
3 Double Heat Sinks	RT	6	3
ER Large Laser	LA	1	4
ER Medium Laser	LA	1	1
3 Double Heat Sinks	LA	6	3
3 Double Heat Sinks	LT	6	3
ER Medium Laser	H	1	1



**Weapons and Ammo Location Critical Tonnage**

*Alternate Configuration A*

LRM 20	RA	4	5
Ammo (LRM) 12	RA	2	2
Streak SRM 6	RT	2	3
Ammo (Streak) 15	RT	1	1
4 Medium Pulse Lasers	LA	4	8
Streak SRM 6	LT	2	3
Ammo (Streak) 15	LT	1	1
Battle Value: 2,319			

*Alternate Configuration B*

6 ER Medium Lasers	RA	6	6
3 Double Heat Sinks	RT	6	3
Ultra AC/20	LA	8	12
Ammo (Ultra) 10	LT	2	2
Battle Value: 2,281			

*Alternate Configuration C*

Large Pulse Laser	RA	2	6
Medium Pulse Laser	RT	1	2
LB 10-X AC	LA	5	10
Ammo (LB-X) 30	LA	3	3
Medium Pulse Laser	LT	1	2
Battle Value: 1,881			

*Alternate Configuration D*

LRM 20	RA	4	5
Ammo (LRM) 18	RA	3	3
Narc Missile Beacon	RT	1	2
Ammo (Narc) 12	RT	2	2
LRM 20	LA	4	5
Ammo (LRM) 18	LA	3	3
2 SRM 2	LT	2	1
Ammo (SRM) 100	LT	2	2
Battle Value: 1,863			

*Alternate Configuration E*

ATM 9	RA	4	5
Ammo (ATM) 21	RA	3	3
ER Medium Laser	RA	1	1
2 ER Small Lasers	RT	2	1
Double Heat Sink	RT	2	1
ATM 9	LA	4	5
Ammo (ATM) 21	LA	3	3
ER Medium Laser	LA	1	1
2 ER Small Lasers	LT	2	1
Double Heat Sink	LT	2	1
Active Probe	H	1	1
Battle Value: 2,113			

**Weapons and Ammo Location Critical Tonnage**

*Alternate Configuration F*

Plasma Cannon	RA	1	3
Ammo (Plasma) 30	RA	3	3
2 AP Gauss Rifles	RA	2	1
Ammo (APGauss) 40	RA	1	1
2 ER Medium Lasers	RT	2	2
ER Small Laser	RT	1	.5
Double Heat Sink	RT	2	1
Plasma Cannon	LA	1	3
Ammo (Plasma) 30	LA	3	3
2 AP Gauss Rifles	LA	2	1
Ammo (APGauss) 40	LA	1	1
2 ER Medium Lasers	LT	2	2
ER Small Laser	LT	1	.5
Double Heat Sink	LT	2	1
Battle Value: 2,227			

*Alternate Configuration G*

5 ER Medium Lasers	RA	5	5
3 Double Heat Sinks	RT	3	3
HAG 20	LA	6	10
Ammo (HAG) 12	LA	2	2
3 Double Heat Sinks	LT	3	3
Battle Value: 2,152			

*Alternate Configuration H*

Heavy Large Laser	RA	3	4
ER Medium Laser	RA	1	1
3 Double Heat Sinks	RA	6	3
3 Double Heat Sinks	RT	6	3
Heavy Large Laser	LA	3	4
ER Medium Laser	LA	1	1
3 Double Heat Sinks	LA	6	3
3 Double Heat Sinks	LT	6	3
ER Medium Laser	H	1	1
Battle Value: 2,061			

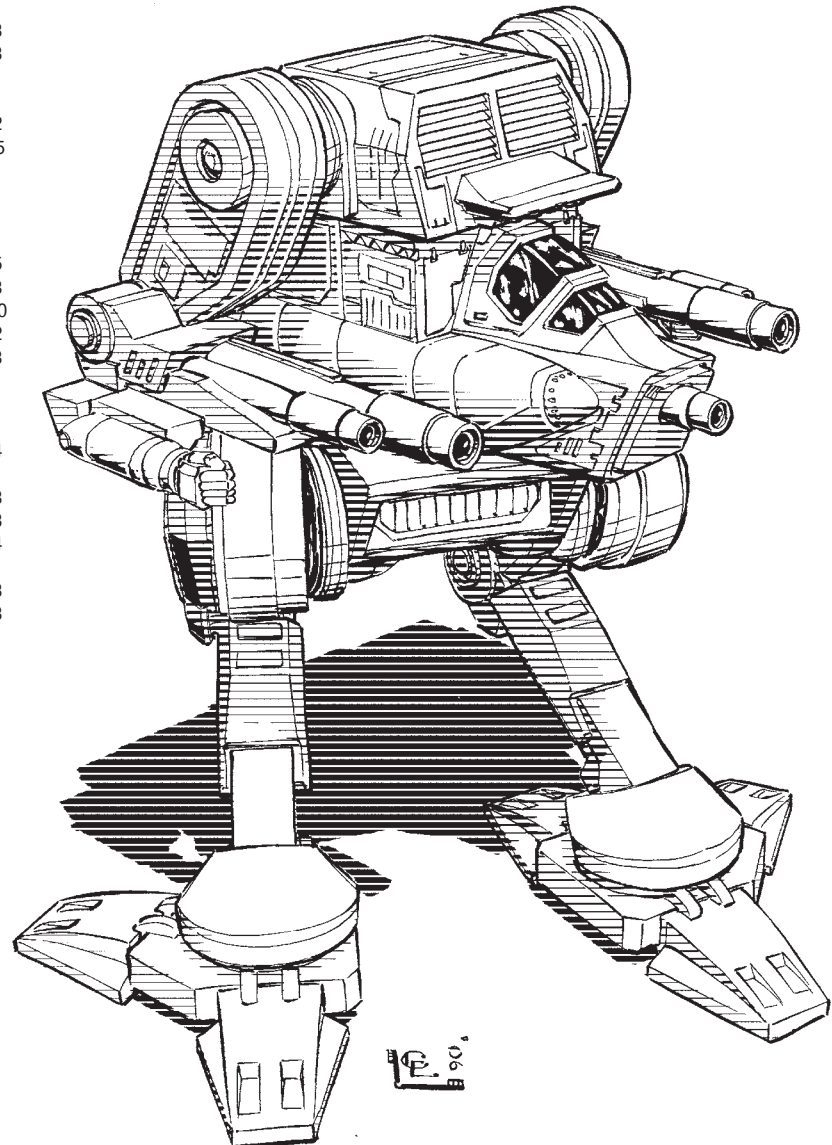



**Mass:** 60 tons  
**Chassis:** Eden Mk 60-OM  
**Power Plant:** 300 Type I XL  
**Cruising Speed:** 54 kph  
**Maximum Speed:** 86 kph  
**Jump Jets:** None  
**Jump Capacity:** None  
**Armor:** Compound SJ6CW Ferro-Fibrous  
**Armament:**  
 28 tons of pod space available  
**Manufacturer:** Various  
**Primary Factory:** Various  
**Communications System:** Build OSJ-41  
**Targeting and Tracking System:** Cat's Eye MD6

## Overview

Clan Smoke Jaguar apparently developed the *Mad Dog* as a second-generation upgrade to an earlier Clan Coyote OmniMech design. Using some design molds and structures common to the *Timber Wolf* (aka *Mad Cat*), the Jaguars apparently named their new Omni as an abstract dig at the expense of the Wolves. When first seen in the Inner Sphere, however, the Kuritan MechWarriors who first encountered this powerful design saw a different totem within the *Mad Dog's* bird-legged stance and narrow, angular torso, and dubbed the 'Mech the *Hagetaka*—widely translated as *Vulture*.

## Capabilities

The *Vulture's* most distinctive feature is its side torso and arm pods, which are practically full modules by themselves, suggesting that the *Vulture* was conceived as a long-range support unit. The torso modules, angled high, are ideal for missiles while the arms serve as extended turrets suited for direct-fire weaponry.

In three of the first four configurations seen in the Inner Sphere, the *Vulture* maintained this concept, sporting mixes of torso-mounted missile racks and arm-mounted clusters of lasers, PPCs, or an autocannon. The C configuration—the only oddball of its day—sporting twin Gauss rifles for the same standoff firepower and a concentrated and devastating direct-fire capability.

The advent of ATMs and heavy lasers interestingly spawned a return to the more customary torso-missile, arm-gun loads with the Coyote D configuration and the Star Adder H payload. Clan Hell's Horses' recent introduction of the hyper-assault Gauss revisited the C configuration concept by focusing on direct-fire weaponry, resulting in the E configuration's pair of HAG 30s (and just enough ammunition for dueling), and the F configuration's laser-backed lighter HAG 20s.

## Deployment

While the *Vulture* is widely produced by virtually all Clans, it is particularly favored by the Hell's Horses and Ghost Bears. Indeed, since their move to the Inner Sphere, Clan Ghost Bear's Bergan Industries factory line is building more and more Clan designs, including a homegrown *Vulture*. Minor variances in structure, armor, and engine design—legacy of Bergan's Spheroid factory tooling—have slightly altered the appearance of these *Vultures*, but these new machines are functionally indistinguishable from their homeworld forebears.

## Notable MechWarriors

**Star Commander Lita:** Nearly past her prime in 3063, Star Commander Lita was assigned to work alongside a promising ristar named Star Captain Jake Kabrinski. Thanks to skills and contacts she earned during her early-invasion experiences as a POW in a Rasalhagian camp, Lita was able to uncover the activities of a Hell's Horses Watch operation on Predlitz and destroyed a Horses supply dump that further weakened their eventual invasion of the planet. She also reportedly assisted Jake Kabrinski in critically wounding the Horses' then-Khan Malavai Fletcher, and she would go on to serve beside Kabrinski in numerous engagements after the final routing of the Horses. In 3068, however, Lita met her end in the cockpit of her *Vulture*, once more battling elements of the Hell's Horses Watch when they raided Rasalhague to capture Jake Kabrinski.

**Type:** Mad Dog  
**Inner Sphere Designation:** Vulture  
**Technology Base:** Clan OmniMech  
**Tonnage:** 60  
**Battle Value:** 2,351

Equipment		Mass
Internal Structure:		6
Engine:	300 XL	9.5
Walking MP:	5	
Running MP:	8	
Jumping MP:	0	
Heat Sinks:	12 [24]	2
Gyro:		3
Cockpit:		3
Armor Factor:	163	8.5
	<i>Internal Structure</i>	<i>Armor Value</i>
Head	3	9
Center Torso	20	23
Center Torso (rear)		7
R/L Torso	14	16
R/L Torso (rear)		7
R/L Arm	10	16
R/L Leg	14	23

## Weight and Space Allocation

Location	Fixed	Spaces Remaining
Head	1 Ferro-Fibrous	0
Center Torso	None	2
Right Torso	2 XL Engine	8
	2 Ferro-Fibrous	
Left Torso	2 XL Engine	8
	2 Ferro-Fibrous	
Left Arm	1 Ferro-Fibrous	7
Right Arm	1 Ferro-Fibrous	7
Right Leg	None	2
Left Leg	None	2

## Weapons and Ammo Location Critical Tonnage

<i>Primary Weapons Configuration</i>			
Large Pulse Laser	RA	2	6
Medium Pulse Laser	RA	1	2
LRM 20	RT	4	5
Ammo (LRM) 6	RT	1	1
Large Pulse Laser	LA	2	6
Medium Pulse Laser	LA	1	2
LRM 20	LT	4	5
Ammo (LRM) 6	LT	1	1

**Weapons and Ammo Location Critical Tonnage**

*Alternate Configuration A*

ER PPC	RA	2	6
3 SRM 6	RT	3	4.5
Ammo (SRM) 30	RT	2	2
LB 5-X AC	LA	4	7
Ammo (LB-X) 40	LA	2	2
3 SRM 6	LT	3	4.5
Ammo (SRM) 30	LT	2	2
Battle Value: 1,923			

*Alternate Configuration B*

3 Medium Pulse Lasers	RA	3	6
2 Streak SRM 6	RT	4	6
Ammo (Streak) 15	RT	1	1
2 ER Large Lasers	LA	2	8
LRM 20	LT	4	5
Artemis IV FCS	LT	1	1
Ammo (LRM) 6	LT	1	1
Battle Value: 2,284			

*Alternate Configuration C*

Gauss Rifle	RA	6	12
Ammo (Gauss) 16	RA	2	2
Gauss Rifle	LA	6	12
Ammo (Gauss) 16	LA	2	2
Battle Value: 1,892			

*Alternate Configuration D*

ER Medium Laser	RA	1	1
ER Small Laser	RA	1	.5
Double Heat Sink	RA	2	1
ATM 12	RT	5	7
Ammo (ATM) 15	RT	3	3
ER Medium Laser	LA	1	1
ER Small Laser	LA	1	.5
ATM 12	LT	5	7
Ammo (ATM) 15	LT	3	3
2 Medium Pulse Lasers	CT	2	4
Battle Value: 2,447			

*Alternate Configuration E*

HAG 30	RA	8	13
Ammo (HAG) 4	RT	1	1
HAG 30	LA	8	13
Ammo (HAG) 4	LT	1	1
Battle Value: 2,031			

*Alternate Configuration F*

HAG 20	RA	6	10
Ammo (HAG) 12	RT	2	2
2 ER Medium Lasers	RT	2	2
HAG 20	LA	6	10
Ammo (HAG) 12	LT	2	2
2 ER Medium Lasers	LT	2	2
Battle Value: 2,300			

**Weapons and Ammo Location Critical Tonnage**

*Alternate Configuration H*

Heavy Large Laser	RA	3	4
3 Double Heat Sinks	RA	6	3
LRM 15	RT	2	3.5
Artemis IV FCS	RT	1	1
Ammo (LRM) 16	RT	2	2
Double Heat Sink	RT	2	1
3 Heavy Medium Lasers	LA	6	3
Double Heat Sink	LA	2	1
LRM 15	LT	2	3.5
Artemis IV FCS	LT	1	1
Ammo (LRM) 16	LT	2	2
Double Heat Sink	LT	2	1
Double Heat Sink	RL	2	1
Double Heat Sink	LL	2	1
Battle Value: 2,097			

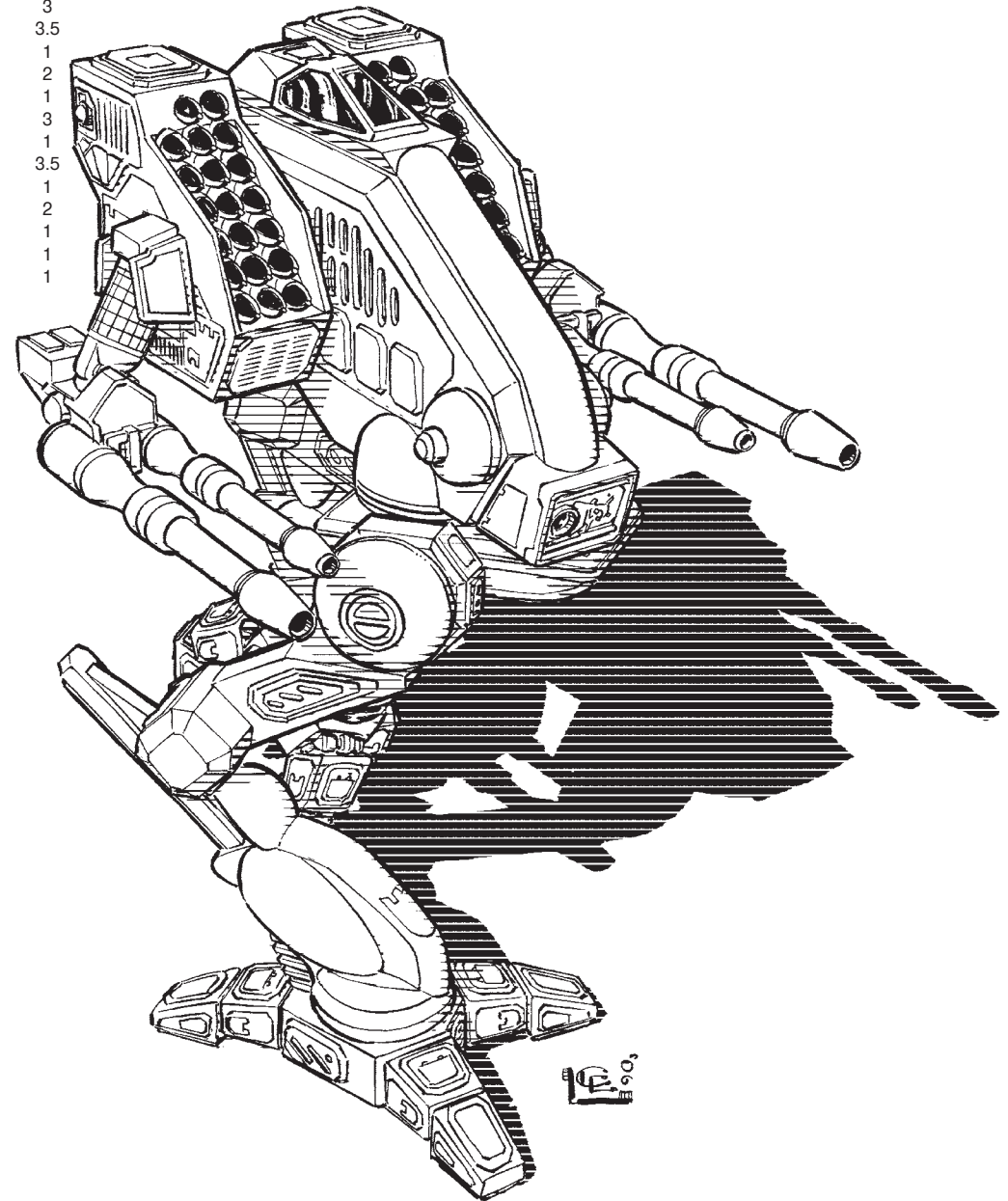



**Mass:** 65 tons  
**Chassis:** T-E H65 Standard  
**Power Plant:** Fusion 325 XL  
**Cruising Speed:** 54 kph  
**Maximum Speed:** 86 kph  
**Jump Jets:** None  
**Jump Capacity:** None  
**Armor:** Forging Omni-H24  
**Armament:**  
 28.5 tons of pod space available  
**Manufacturer:** Various  
**Primary Factory:** Various  
**Communications System:** CH2B Alpha-Com  
**Targeting and Tracking System:** Version Delta-II TTS(A)

### Overview

After losing Tokasha MechWorks to Clan Ghost Bear, the Hell's Horses addressed OmniMech attrition with numerous "crash" projects—developing heavy, less expensive OmniMechs, maximizing their firepower. Unfortunately, their only lasting success in this endeavor (and a questionable one at that) was the *Hellbringer*, a heavy OmniMech that received the nickname *Loki* from FedCom forces.

### Capabilities

As with many "second generation" OmniMechs, the *Loki* shares molds and structural components of other Omni designs like the *Thor*. Its chassis, however, clearly descends from venerable *Warhammer* or *Thunderbolt* machines used for ages by the Inner Sphere, betraying some corner cutting when the Horses rushed the *Loki* into production at their Eden complexes. Other signs of this "rush job" are apparent in the *Loki's* sacrifice of tonnage for pod capacity, which left it as mobile as most Clans' heavyweights, but surprisingly under-armored.

It seems this emphasis on pod space inspired Clan technicians and MechWarriors alike to cram the widest possible armament range into every common *Loki* configuration. The Primary, A, and B configurations all present unusual mixtures of autocannon, missiles, and lasers, creating payloads that emphasize no particular ability, range, or attack specialty. The recent advent of ATMs and heavy lasers spawned even more weapon options, with the C configuration carrying a mix of lasers supported by an LB 20-X and an ATM-6, while the Crusader-favored H load carries a smattering of heavy lasers, LRMs, and an autocannon.

Clans Jade Falcon and Hell's Horses have introduced two new mission-specific configurations that sport the latest in Clan weaponry. The Falcons' D configuration is an obvious anti-battlesuit configuration, carrying a balanced mix of plasma cannons, pulse lasers, and B-Pods to decimate infantry formations, while the Horses' E version uses jump jets and a combination of ER large lasers, an LRM-15 rack, and a hyper-assault Gauss for solid punch at medium to long ranges.

### Deployment

The Horses lost exclusive production over the *Loki* line soon after its initial deployment, and they may have deliberately shared the design with other Clans to curry favor or to obtain supplies. The result was a widespread dispersion of the OmniMech to various nearby Clans. While every Clan possesses or at least has regular access to production facilities for the *Loki*, the last decade has seen a sharp decline in the 'Mech's numbers, particularly among the Crusader Clans who find its under-armored design obsolete in the face of newer models and technologies.

### Notable MechWarriors

**Star Captain Phadorah:** At the helm of a *Loki* E, Phadorah (reportedly of the Ravenwater Bloodname House) led a Nova of Horses OmniMechs and ProtoMechs in the recent capture of New Caledonia from Clan Wolf. At the peak of the fighting, Phadorah reportedly engaged and defeated two Wolf Clan 'Mechs simultaneously, including that of former Horseman Akira Amirault, Star Colonel of the Wolves' Thirty-third Wolf Champions. Phadorah's "reclamation" of Amirault has already put this young and reformed Crusader on the fast track to earning her own Bloodname.

Type: **Hellbringer**  
 Inner Sphere Designation: **Loki**  
 Technology Base: Clan OmniMech  
 Tonnage: 65  
 Battle Value: 2,711

Equipment		Mass
Internal Structure:		6.5
Engine:	325 XL	12
Walking MP:	5	
Running MP:	8	
Jumping MP:	0	
Heat Sinks:	13 [26]	3
Gyro:		4
Cockpit:		3
Armor Factor:	128	8
	<i>Internal Structure</i>	<i>Armor Value</i>
Head	3	9
Center Torso	21	17
Center Torso (rear)		8
R/L Torso	15	14
R/L Torso (rear)		7
R/L Arm	10	11
R/L Leg	15	15

### Weight and Space Allocation

Location	Fixed	Spaces Remaining
Head	None	1
Center Torso	None	2
Right Torso	2 XL Engine	10
Left Torso	2 XL Engine	10
Left Arm	None	8
Right Arm	None	8
Right Leg	None	2
Left Leg	None	2

### Weapons and Ammo Location Critical Tonnage

#### Primary Weapons Configuration

Weapon/Ammo	Location	Critical	Tonnage
ER PPC	RA	2	6
Streak SRM 6	RT	2	3
Ammo (Streak) 15	RT	1	1
2 Machine Guns	RT	1	.5
Ammo (MG) 100	RT	1	.5
ER PPC	LA	2	6
ECM Suite	LT	1	1
Active Probe	LT	1	1
Targeting Computer	LT	3	3
3 ER Medium Lasers	LT	1	1
Anti-Missile System	H	1	.5
Ammo (AMS) 24	CT	1	1
2 A-Pods	RL	2	1
2 A-Pods	LL	2	1

**Weapons and Ammo Location Critical Tonnage**

*Alternate Configuration A*

Ultra AC/5	RA	3	7
Ammo (Ultra) 20	RA	1	1
LRM 20	RT	4	5
Ammo (LRM) 6	RT	1	1
2 Machine Guns	RT	2	.5
2 ER Large Lasers	LA	2	8
Active Probe	LT	1	1
Narc Missile Beacon	LT	1	2
Ammo (Narc) 6	LT	1	1
ER Medium Laser	H	1	1
Ammo (MG) 200	CT	1	1
Battle Value: 1,949			

*Alternate Configuration B*

Gauss Rifle	RA	6	12
Ammo (Gauss) 8	RA	1	1
2 SRM 6	RT	2	3
2 Artemis IV FCS	RT	1	2
Ammo (SRM) 30	RT	2	2
LB 5-X AC	LA	4	7
Ammo (LB-X) 20	LA	1	1
ER Small Laser	LT	1	.5
Battle Value: 1,592			

*Alternate Configuration C*

ATM 6	RA	3	3.5
Ammo (ATM) 30	RA	3	3
Ammo (LB-X) 5	RT	1	1
LB 20-X AC	RT	9	12
ER Large Laser	LA	1	4
2 ER Small Lasers	LA	2	1
2 ER Medium Lasers	LT	2	2
Ammo (LB-X) 10	LT	2	2
Battle Value: 2,080			

*Alternate Configuration D*

2 Plasma Cannons	RA	2	6
Ammo (Plamsa) 20	RA	2	2
2 Medium Pulse Lasers	RT	2	4
2 Plasma Cannons	LA	2	6
Ammo (Plamsa) 20	LA	2	2
2 Medium Pulse Lasers	LT	2	4
Micro Pulse Laser	H	1	.5
2 B-Pods	RL	2	2
2 B-Pods	LL	2	2
Battle Value: 2,140			

**Weapons and Ammo Location Critical Tonnage**

*Alternate Configuration E*

2 ER Large Lasers	RA	2	8
LRM 10	RT	1	2.5
Ammo (LRM) 12	RT	1	1
Jump Jets	RT	2	2
HAG 20	LA	6	10
Ammo (HAG) 12	LA	2	2
Jump Jets	LT	2	2
Jump Jet	CT	1	1
Battle Value: 2,304			

*Alternate Configuration H*

ER PPC	RA	2	6
Ultra AC/5	RT	3	7
Ammo (Ultra) 40	RT	2	2
Heavy Large Laser	LA	3	4
4 Heavy Small Lasers	LT	4	2
LRM 15	LT	2	3.5
Ammo (LRM) 16	LT	2	2
Active Probe	LT	1	1
A-Pod	RL	1	.5
A-Pod	LL	1	.5
Battle Value: 1,953			

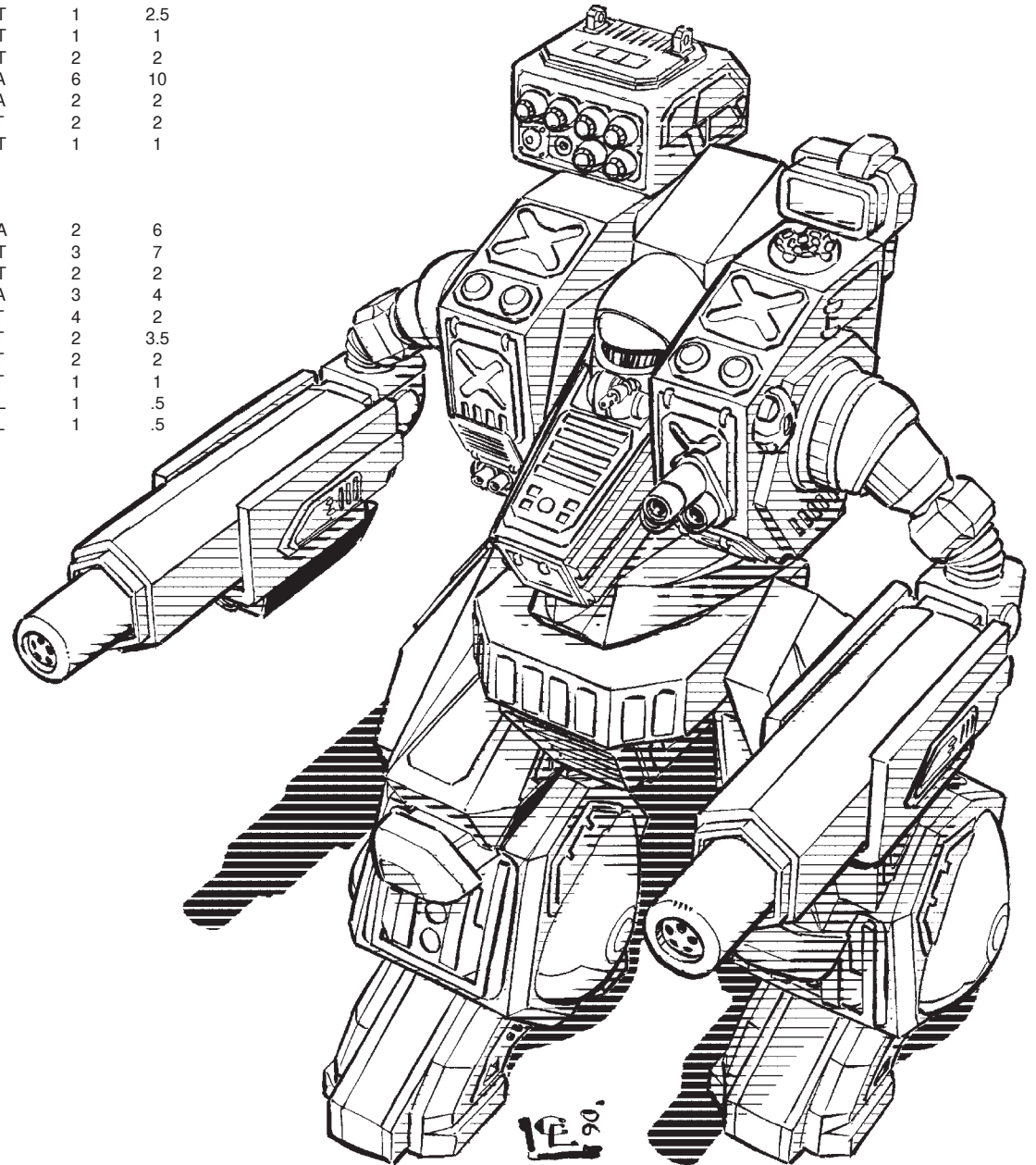



**Mass:** 70 tons

**Chassis:** JFS-703

**Power Plant:** Redline 350 XL

**Cruising Speed:** 54 kph

**Maximum Speed:** 86 kph

**Jump Jets:** JF Standard

**Jump Capacity:** 150 m

**Armor:** J63-3E Ferro Fibrous

**Armament:**

22.5 tons of pod space available

**Manufacturer:** Eagle Craft Group, St. Louis MechWorks

**Primary Factory:** Ironhold, Niles

**Communications System:** Model J-D 067

**Targeting and Tracking System:** Hawkeye 58

## Overview

The *Summoner*, dubbed the *Thor* in the Inner Sphere, is a mobile heavy 'Mech designed to accommodate a bulky weapons load. Often unfairly compared to the *Timber Wolf*, the *Thor* was built with mobility for both offense and defense. The design dates back nearly two hundred years to when the Jade Falcons used captured *Threshers* as a basis for a new OmniMech. It has been successful as both a raider and a quick-strike assault unit, and members of the LAAF are all too familiar with its capabilities.

## Capabilities

In its Primary configuration, the *Summoner* does well as a raider. Relying on an ER PPC for most of its firepower, an LRM 15 and LB-class autocannon provide additional long-range punch. The A version has a similar profile but is more close-range focused. The B model, armed mainly with missiles, is used for fire support. The C configuration

centers on an Ultra autocannon/20, one of the most feared weapons on the battlefield. Perhaps one of the most efficient uses of the design is the D configuration, with ER lasers on each arm and a targeting computer.

A recent sighting, the E model takes advantage of the new ATM missile system. The advent of the heavy laser led to the H model, focusing on a pair of heavy large lasers and ER mediums. A mix of the Primary and Alpha configurations, the M seems to be meant for close-in fighting. The ER PPC gives it range, but the LB autocannon is again short on ammo while the Streak-6 rack has two tons.

Two new versions have recently cropped up; the first is the HH, which focuses on the hyper-assault Gauss rifle. Used by Hell's Horses warriors, it also mounts the new plasma cannon and various medium lasers. The configuration made popular by Quinn Kerensky, dubbed the G, centers on SRM racks in each torso and energy weapons in the arms. For close-in firepower, heavy lasers have been added.

## Deployment

The *Summoner* was three times as common in Jade Falcon units than other Clans during the initial invasion, and it has grown increasingly more so as other Clans have made newer designs in the same weight class. A Clan Coyote adage says, "If you see a Falcon not in a *Summoner*, *Hellbringer* or *Kit Fox*, double your caution."

## Notable MechWarriors

**Star Captain Quinn Kerensky:** Following in the footsteps of her ancestors, Quinn was never one to go with the flow just for the sake of going. A gifted MechWarrior and a good leader, her attitude eventually caught up with her; when challenged by the Falcons for a Trial of Possession for her, her commander bid low and sent her out. Since she has joined the Falcons, Quinn has become among the most aggressive against her former Clan, seeking to be allowed to someday challenge for her genetic heritage. Most Clan warriors find physical attacks offensive, but Quinn likes to tap an opponent to showcase her skills and taunt her opponents.

Type: **Summoner**

Inner Sphere Designation: **Thor**

Technology Base: Clan OmniMech

Tonnage: 70

Battle Value: 2,298

Equipment		Mass
Internal Structure:		7
Engine:	350 XL	15
Walking MP:	5	
Running MP:	8	
Jumping MP:	5	
Heat Sinks:	14 [28]	4
Gyro:		4
Cockpit:		3
Armor Factor:	182	9.5
	<i>Internal Structure</i>	<i>Armor Value</i>
Head	3	9
Center Torso	22	27
Center Torso (rear)		8
R/L Torso	15	22
R/L Torso (rear)		7
R/L Arm	11	17
R/L Leg	15	23

## Weight and Space Allocation

Location	Fixed	Spaces Remaining
Head	1 Ferro-Fibrous	0
Center Torso	Jump Jet	1
Right Torso	2 XL Engine	8
	2 Ferro-Fibrous	
Left Torso	2 XL Engine	8
	2 Ferro-Fibrous	
Left Arm	1 Ferro-Fibrous	7
Right Arm	1 Ferro-Fibrous	7
Right Leg	2 Jump Jets	0
Left Leg	2 Jump Jets	0

## Weapons and Ammo Location Critical Tonnage

### Primary Weapons Configuration

ER PPC	RA	2	6
LB 10-X AC	LA	5	10
Ammo (LB-X) 10	LA	1	1
LRM 15	LT	1	3.5
Ammo (LRM) 16	LT	2	2

### Alternate Configuration A

Large Pulse Laser	RA	2	6
Gauss Rifle	LA	6	12
Ammo (Gauss) 8	LA	1	1
SRM 6	LT	1	1.5
Ammo (SRM) 30	LT	2	2

Battle Value: 2,145

**Weapons and Ammo Location Critical Tonnage**

*Alternate Configuration B*

LRM 20	RA	4	5
Ammo (LRM) 12	RA	2	2
SRM 4	RA	1	1
Ammo (SRM) 25	RA	1	1
LRM 20	LA	4	5
Ammo (LRM) 12	LA	2	2
SRM 4	LA	1	1
Ammo (SRM) 25	LA	1	1
Anti-Missile System	LT	1	.5
Ammo (AMS) 24	LT	1	1
NARC Beacon	LT	1	1
Ammo (Narc) 6	LT	1	1

Battle Value: 2,159

*Alternate Configuration C*

ER Large Laser	RA	1	4
ER Small Laser	RA	1	.5
Ultra AC/20	LA	8	12
Ammo (Ultra) 10	LT	2	2
Streak SRM 6	LT	2	3
Ammo (Streak) 15	LT	1	1

Battle Value: 2,379

*Alternate Configuration D*

ER Large Laser	RA	1	4
ER Medium Laser	RA	1	1
3 Double Heat Sinks	RA	6	3
Machine Gun	RT	1	.25
Anti-Missile System	RT	1	.5
Targeting Computer	RT	2	2
ER Large Laser	LA	1	4
ER Medium Laser	LA	1	1
3 Double Heat Sinks	LA	6	3
Machine Gun	LT	1	.25
Ammo (MG) 200	LT	1	1
Anti-Missile System	LT	1	.5
Ammo (AMS) 48	LT	2	2

Battle Value: 2,643

*Alternate Configuration E*

ATM 12	RA	5	7
ATM 6	RA	3	3.5
Ammo (ATM) 15	RT	3	3
Ammo (ATM) 30	RT	3	3
ER PPC	LA	2	6

Battle Value: 2,612

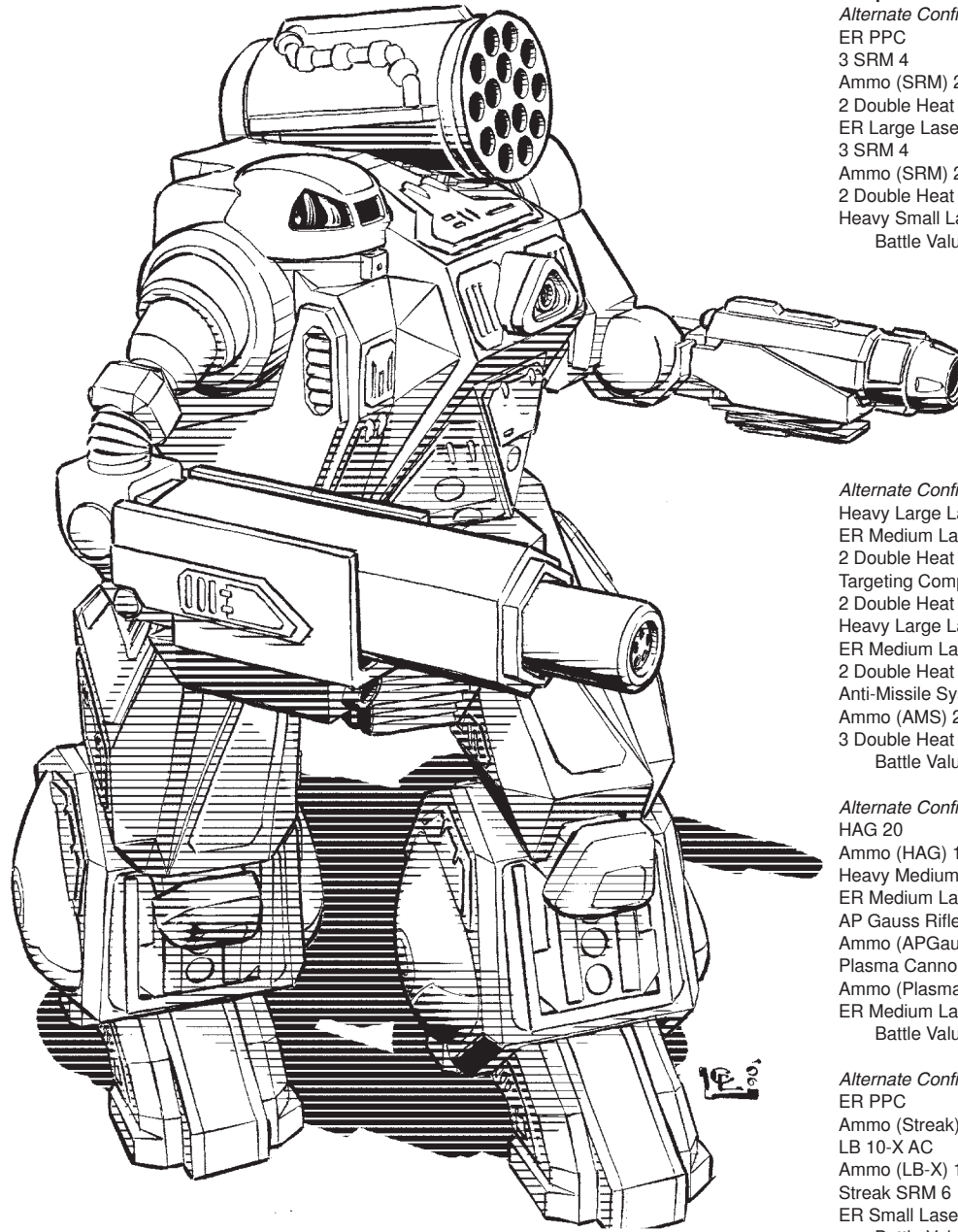

**Weapons and Ammo Location Critical Tonnage**

*Alternate Configuration G*

ER PPC	RA	2	6
3 SRM 4	RT	3	3
Ammo (SRM) 25	RT	1	1
2 Double Heat Sinks	RT	4	2
ER Large Laser	LA	1	4
3 SRM 4	LT	3	3
Ammo (SRM) 25	LT	1	1
2 Double Heat Sinks	LT	4	2
Heavy Small Laser	CT	1	.5

Battle Value: 2,452

*Alternate Configuration H*

Heavy Large Laser	RA	3	4
ER Medium Laser	RA	1	1
2 Double Heat Sinks	RA	4	2
Targeting Computer	RT	2	2
2 Double Heat Sinks	LA	4	2
Heavy Large Laser	LA	3	4
ER Medium Laser	LA	1	1
2 Double Heat Sinks	LA	4	2
Anti-Missile System	LT	1	.5
Ammo (AMS) 24	LT	1	1
3 Double Heat Sinks	LT	6	3

Battle Value: 2,536

*Alternate Configuration HH*

HAG 20	RA	6	10
Ammo (HAG) 18	RA	3	3
Heavy Medium Laser	RT	2	1
ER Medium Laser	LA	1	1
AP Gauss Rifle	LA	1	.5
Ammo (APGauss) 40	LA	1	1
Plasma Cannon	LT	1	3
Ammo (Plasma) 20	LT	2	2
ER Medium Laser	CT	1	1

Battle Value: 2,490

*Alternate Configuration M*

ER PPC	RA	2	6
Ammo (Streak) 30	RT	2	2
LB 10-X AC	LA	5	10
Ammo (LB-X) 10	LA	1	1
Streak SRM 6	LT	2	3
ER Small Laser	LT	1	.5

Battle Value: 2,251



**Mass:** 75 tons  
**Chassis:** Type W3 Endo-steel  
**Power Plant:** Starfire 375 XL  
**Cruising Speed:** 54 kph  
**Maximum Speed:** 86 kph  
**Jump Jets:** None  
**Jump Capacity:** None  
**Armor:** Composite A-2 Ferro-Fibrous  
**Armament:**

27.5 tons of pod space available  
**Manufacturer:** Wolf Clan Site #2, Wolf Clan Site 1  
**Primary Factory:** Strana Mechty, Arc-Royal  
**Communications System:** Khan Series (Type 2c)  
**Targeting and Tracking System:** Series III OPT

## Overview

The first OmniMech the Inner Sphere encountered, the *Mad Cat* was so named by ComStar analysts for its resemblance to both the *Marauder* and *Catapult*. Built by Clan Wolf, the *Timber Wolf* has proven to be a near-perfect blending of advanced Clan technologies in a single lethal machine.

## Capabilities

Fast and well armored, the *Mad Cat* is also endowed with a generous pod capacity. The Primary configuration is a well-balanced mix of lasers and missiles, equally deadly at short and long-range. Configuration B has a weapon mix better suited to combat at intermediate ranges and is a popular choice for dueling. The C configuration is something of a compromise in order to fit a Gauss rifle, and it remains relatively uncommon. With its rear-firing missile packs, configuration D is well suited to the kind of infighting seen in a Bloodname Grand Melee, or in use against Inner Sphere opponents.

Contact with Inner Sphere tactics prompted the development of Configuration S. Geared for urban combat and dealing with conventional infantry, this version is becoming a common sight in the Clan Occupation Zone.

The OmniMech's unique strengths allow for rapid adoption of new technology. The E and H configurations are configurations of the prime that have been modified to incorporate ATM and heavy laser technology respectively. Faced with the realities of modern warfare, the Jade Falcons have adopted new anti-personnel weapons on their *Mad Cats*. Mounting three of the new anti-personnel Gauss rifles, the F configuration is equally efficient against battle armor as it is against conventional infantry.

## Deployment

Clan Wolf introduced the *Mad Cat* in 2945 to help replace the aging *Woodsmen* OmniMech. Debuting with the Fourth Wolf Guard, the *Mad Cat* was a nasty surprise for the Sea Foxes (now Clan Diamond Shark). Fast and powerful, two Trinaries composed primarily of the new OmniMech rolled over the Thirteenth Cruiser Cluster defending the oil fields on Priori. Since that victory, the Wolves have jealously guarded the rights to build the *Mad Cat* in numerous Trials of Possession. Unable to manufacture their own *Mad Cats*, other Clans must fall back on battlefield salvage or trade to acquire the design. Consequently the other Clans field only a modest number of *Mad Cats*.

Much of the credit for the Wolves' success during Operation Revival must be laid at the feet of the *Mad Cat*. Inner Sphere MechWarriors found their equipment woefully inferior to the deadly OmniMech. It is little wonder that the *Mad Cat* quickly came to symbolize the Clans' technical superiority.

Although the *Mad Cat* is an aging design, the Wolves' attempts to develop a replacement have been unsuccessful. It is difficult to say whether the Wolves are more irritated or amused by the Diamond Sharks' knock off design, the *Mad Cat Mk II*.

## Notable MechWarriors

**The Bounty Hunter:** Now piloting a *Mad Cat* captured from the Smoke Jaguars during the Clan Invasion, the Bounty Hunter's bright green 'Mech, decorated with credit symbols, is once more a much-feared sight across the battlefields of the Inner Sphere and Clan Occupation Zones. Of course it is the highest of ironies (lost on most Clansmen) that the most famous and feared *Mad Cat* pilot alive is not only a Spheroid, but the worst sort of mercenary.

Type: **Timber Wolf**  
 Inner Sphere Designation: **Mad Cat**  
 Technology Base: Clan OmniMech  
 Tonnage: 75  
 Battle Value: 2,737

Equipment		Mass
Internal Structure:	Endo Steel	4
Engine:	375 XL	19.5
Walking MP:	5	
Running MP:	8	
Jumping MP:	0	
Heat Sinks:	15 [30]	5
Gyro:		4
Cockpit:		3
Armor Factor:	230	12
	<i>Internal Structure</i>	<i>Armor Value</i>
Head	3	9
Center Torso	23	36
Center Torso (rear)		9
R/L Torso	16	25
R/L Torso (rear)		7
R/L Arm	12	24
R/L Leg	16	32

## Weight and Space Allocation

Location	Fixed	Spaces Remaining
Head	1 Ferro-Fibrous	0
Center Torso	1 Endo Steel	1
Right Torso	2 XL Engine 1 Endo Steel	7
Left Torso	2 Ferro-Fibrous 2 XL Engine 1 Endo Steel	7
Left Arm	2 Ferro-Fibrous	
Right Arm	1 Ferro-Fibrous	7
Right Leg	1 Ferro-Fibrous	7
Right Leg	2 Endo Steel	0
Left Leg	2 Endo Steel	0

## Weapons and Ammo Location Critical Tonnage

Primary Weapons Configuration			
ER Large Laser	RA	1	4
ER Medium Laser	RA	1	1
Double Heat Sink	RA	2	1
Machine Gun	RT	1	.25
Ammo (MG) 200	RT	1	1
LRM 20	RT	4	5
Ammo (LRM) 6	RT	1	1
ER Large Laser	LA	1	4
ER Medium Laser	LA	1	1
Double Heat Sink	LA	2	1
Medium Pulse Laser	LT	1	2
LRM 20	LT	4	5
Ammo (LRM) 6	LT	1	1
Machine Gun	CT	1	.25



**Weapons and Ammo Location Critical Tonnage**

*Alternate Configuration A*

ER PPC	RA	2	6
3 Double Heat Sinks	RA	6	3
Streak SRM 6	RT	2	3
Ammo (Streak) 15	RT	1	1
ER PPC	LA	2	6
2 Double Heat Sinks	LA	4	2
3 Medium Pulse Lasers	LT	3	6
ER Small Laser	CT	1	.5
Battle Value: 2,854			

*Alternate Configuration B*

Gauss Rifle	RA	6	12
Ammo (Gauss) 8	RA	1	1
SRM 4	RT	1	1
Ammo (SRM) 25	RT	1	1
Artemis IV FCS	RT	1	1
Large Pulse Laser	LA	2	6
Small Pulse Laser	LA	1	1
LRM 10	LT	1	2.5
Ammo (LRM) 12	LT	1	1
Artemis IV FCS	LT	1	1
Battle Value: 2,224			

*Alternate Configuration C*

Ultra AC/5	RA	3	7
Ammo (Ultra) 20	RA	1	1
LRM 15	RT	2	3.5
Ammo (LRM) 8	RT	1	1
Ammo (AMS) 24	RT	1	1
2 ER Large Lasers	LA	2	8
LRM 15	LT	2	3.5
Ammo (LRM) 8	LT	1	1
Anti-Missile System	LT	1	.5
ER Medium Laser	CT	1	1
Battle Value: 2,500			

*Alternate Configuration D*

ER PPC	RA	2	6
Streak SRM 6	RT	2	3
Streak SRM 6	RT (R)	2	3
Ammo (Streak) 30	RT	2	2
ER PPC	LA	2	6
Streak SRM 6	LT	2	3
Streak SRM 6	LT (R)	2	3
Ammo (Streak) 15	LT	1	1
ER Small Laser	CT	1	.5
Battle Value: 2,682			

**Weapons and Ammo Location Critical Tonnage**

*Alternate Configuration E*

ER Large Laser	RA	1	4
2 Double Heat Sinks	RA	4	2
ATM 9	RT	4	5
Ammo (ATM) 21	RT	3	3
ER Large Laser	LA	1	4
Double Heat Sink	LA	2	1
ATM 9	LT	4	5
Ammo (ATM) 21	LT	3	3
Light TAG	CT	1	.5
Battle Value: 2,444			

*Alternate Configuration F*

ER Large Laser	RA	1	4
ER Medium Laser	RA	1	1
Double Heat Sink	RA	2	1
AP Gauss Rifle	RT	1	.5
Ammo (APGauss) 40	RT	1	1
LRM 20	RT	4	5
Ammo (LRM) 6	RT	1	1
ER Large Laser	LA	1	4
ER Medium Laser	LA	1	1
Double Heat Sink	LA	2	1
AP Gauss Rifle	LT	1	.5
LRM 20	LT	4	5
Ammo (LRM) 6	LT	1	1
ER Medium Laser	LT	1	1
AP Gauss Rifle	CT	1	.5
Battle Value: 2,765			

*Alternate Configuration H*

Heavy Large Laser	RA	3	4
2 Double Heat Sinks	RA	4	2
LRM 20	RT	4	5
Ammo (LRM) 12	RT	2	2
Artemis IV FCS	RT	1	1
Heavy Large Laser	LA	3	4
Double Heat Sink	LA	2	1
LRM 20	LT	4	5
Ammo (LRM) 12	LT	2	2
Artemis IV FCS	LT	1	1
ER Small Laser	CT	1	.5
Battle Value: 2,476			

*Alternate Configuration S*

2 Medium Pulse Lasers	RA	2	4
Ammo (SRM) 30	RA	2	2
Double Heat Sink	RA	2	1
ER Small Laser	RT	1	.5
Machine Gun	RT	1	.25
Ammo (MG) 100	RT	1	.5
2 SRM 6	RT	2	3
Jump Jets	RT	2	2
Large Pulse Laser	LA	2	6
Ammo (SRM) 30	LA	2	2
Machine Gun	LT	1	.25
2 SRM 6	LT	2	3
Jump Jets	LT	2	2
Jump Jet	CT	1	1
Battle Value: 2,462			

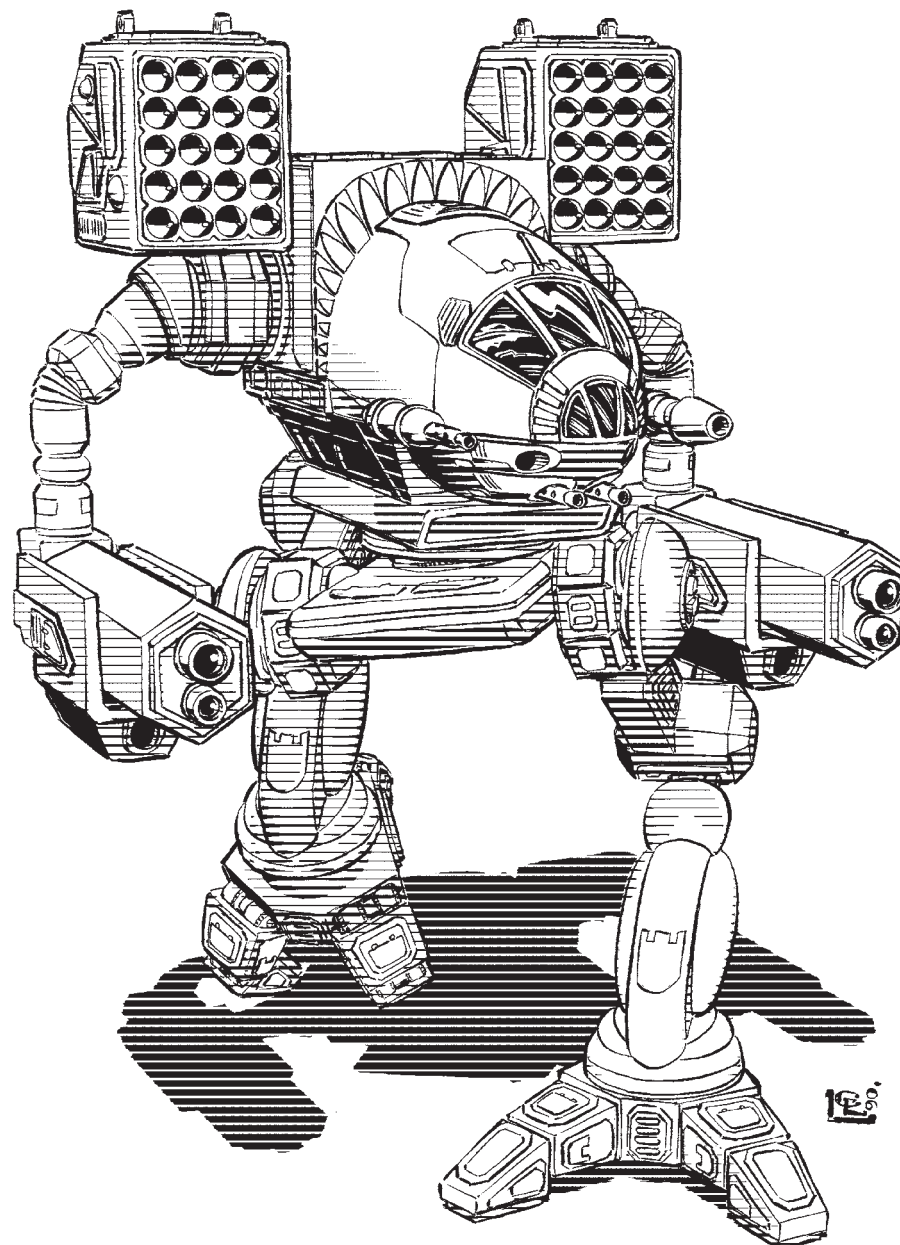

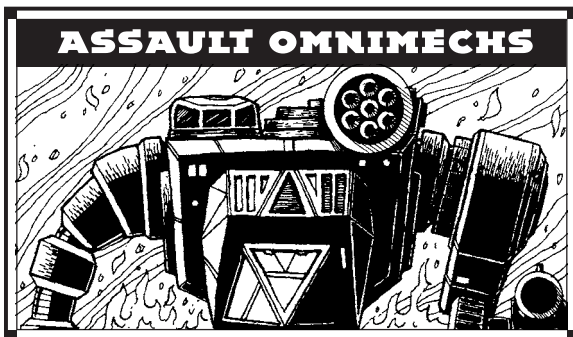

**Mass:** 80 tons  
**Chassis:** Clan Series Assault SXC  
**Power Plant:** 400 Model SF-3 XL  
**Cruising Speed:** 54 kph  
**Maximum Speed:** 86 kph  
**Jump Jets:** None  
**Jump Capacity:** None  
**Armor:** Forging C629/j Ferro-Fibrous  
**Armament:**  
 21.5 tons of pod space available  
**Manufacturer:** Wolf Clan Site OZ-1, Tokasha Mechworks  
**Primary Factory:** Tamar, Tokasha  
**Communications System:** Raldon R1  
**Targeting and Tracking System:** Version Kappa-III TTS

## Overview

Fast for an assault-class 'Mech, the *Gargoyle* (commonly called the *Man-o'-War* in the Inner Sphere) instilled shock and terror among many of the Spheroid MechWarriors who faced it during the initial Clan Invasion. Because the majority of the pod space lay in the arms, switching out weapon layouts required little time between missions—leading many Inner Sphere commanders to believe that the Invader Clans had more of these 'Mechs than they actually possessed.

The 'Mech's superb mobility was also its greatest weakness, however, as the more veteran pilots of the Inner Sphere would target the 'Mech's arms. By amputating the *Man-o'-War's* firepower, the machine could be ignored and bypassed, leaving a frustrated and irate Clan warrior on the battlefield.

## Capabilities

Designed by Clan Wolf alongside the *Mad Cat* as a successor to the aging *Woodman*, the *Man-o'-War* is

still considered one of the more deadly assault-class BattleMechs fielded by the Invader Clans. Its primary weapon remains its surprising speed, which it can maintain without any MASC-enhanced musculature, making the fastest known Clan assault OmniMech in use. The oversized engine comes with a price, however, restricting the useable pod space to a paltry 21.5 tons, rarely enough to allow the *Man-o'-War* to mount more than one heavy-hitting assault weapon.

## Deployment

Found mainly in Invader Clan Galaxies, the *Man-o'-War* is rarely seen among Home Clan forces except among the Ice Hellions, who value the design's speed over its punch. Among the Hellions, the *Man-o'-War* can usually be found augmenting Pursuit Stars and in rare cases, the backbone of a Flurry unit. The newer G configuration is found exclusively among the Hellions and seems to be designed for use against the Horses, considering the preponderance of anti-infantry and vehicle weaponry mounted on it.

The M configuration is rarely seen—most likely a failed attempt at incorporating the HAG system on a speedier platform. This configuration has been spotted in some use with the Horses and Mandrills, but usually as a support Point in Command Stars.

## Notable MechWarriors

**Khan Silas Kufahl:** Eschewing his normal *Savage Coyote*, Khan Kufahl piloted one of the newer E configurations in his highly visible Trial of Grievance against Khan Kardaán in 3068. Kufahl used the *Man-o'-War's* speed to his advantage, slowly cutting down the Cobra Khan's *Warhawk* Prime until it dropped. Unwilling to show Kardaán any mercy for his audacity in declaring a Reaving against his Coyotes, Kufahl cored the *Warhawk's* engine, causing it to explode. A piece of Kardaán's 'Mech blasted through Kufahl's cockpit, nicking his windpipe. Though the timely response by Coyote technicians saved Kufahl's life, the Coyote Khan must utilize an electronic vocalizer because of damage to his vocal cords. The Khan refuses to use such a device in the Grand Council, however, relying more upon his saKhan to handle the Coyote's response during Council sessions rather than appear weak to his peers. Consequently, when Kufahl speaks, it is when he believes it is of great importance to his Clan.

Type: **Gargoyle**  
 Inner Sphere Designation: **Man-o'-War**  
 Technology Base: Clan OmniMech  
 Tonnage: 80  
 Battle Value: 1,537

Equipment		Mass
Internal Structure:		8
Engine:	400 XL	26.5
Walking MP:	5	
Running MP:	8	
Jumping MP:	0	
Heat Sinks:	16 [32]	6
Gyro:		4
Cockpit:		3
Armor Factor:	211	11
	<i>Internal Structure</i>	<i>Armor Value</i>
Head	3	9
Center Torso	25	30
Center Torso (rear)		10
R/L Torso	17	24
R/L Torso (rear)		10
R/L Arm	13	23
R/L Leg	17	24

## Weight and Space Allocation

Location	Fixed	Spaces Remaining
Head	1 Ferro-Fibrous	0
Center Torso	None	2
Right Torso	2 XL Engine	8
	2 Ferro-Fibrous	
Left Torso	2 XL Engine	8
	2 Ferro-Fibrous	
Left Arm	1 Ferro-Fibrous	7
Right Arm	1 Ferro-Fibrous	7
Right Leg	None	2
Left Leg	None	2

## Weapons and Ammo Location Critical Tonnage

Primary Weapons Configuration			
LB 5-X AC	RA	4	7
SRM 6	RA	1	1.5
Ammo (LB-X) 20	RT	1	1
Ammo (SRM) 15	RT	1	1
LB 5-X AC	LA	4	7
SRM 6	LA	1	1.5
Ammo (LB-X) 20	LT	1	1
Ammo (SRM) 15	LT	1	1
ER Small Laser	CT	1	.5

## Alternate Configuration A

2 ER PPC	RA	4	12
Large Pulse Laser	LA	2	6
Medium Pulse Laser	LA	1	2
ER Medium Laser	LA	1	1
ER Small Laser	LA	1	.5

Battle Value: 2,689

**Weapons and Ammo Location Critical Tonnage**
*Alternate Configuration B*

Gauss Rifle	RA	6	12
Ammo (Gauss) 16	RA	2	2
LRM 10	LA	1	2.5
Artemis IV FCS	LA	1	1
Ammo (LRM) 12	LA	1	1
SRM 4	LA	1	1
Artemis IV FCS	LA	1	1
Ammo (SRM) 25	LA	1	1
Battle Value: 1,843			

*Alternate Configuration C*

6 ER Medium Lasers	RA	6	6
Ultra AC/20	LA	8	12
Ammo (Ultra) 10	LT	2	2
2 A-Pods	RL	2	1
A-Pod	LL	1	.5
Battle Value: 2,417			

*Alternate Configuration D*

ER Large Laser	RA	1	4
Medium Pulse Laser	RA	1	2
2 Double Heat Sinks	RT	4	2
ER Large Laser	LA	1	4
Medium Pulse Laser	LA	1	2
Targeting Computer	LT	3	3
2 Double Heat Sinks	LT	4	2
Medium Pulse Laser	CT	1	2
ER Small Laser	CT	1	.5
Battle Value: 2,499			

*Alternate Configuration E*

ATM 12	RA	5	7
Ammo (ATM) 15	RA	3	3
2 ER Micro Lasers	RT	2	.5
2 Heavy Medium Lasers	LA	4	2
2 Heavy Medium Lasers	LT	4	2
Streak SRM 6	LT	2	3
Ammo (Streak) 15	LT	1	1
Targeting Computer	CT	1	1
2 Double Heat sinks	RL	2	1
2 Double Heat sinks	LL	2	1
Battle Value: 2,257			

*Alternate Configuration G*

LB 20-X AC	RA	9	15
Ammo (LB-X) 15	RT	3	3
3 AP Gauss Rifles	LA	3	2.5
Ammo (APGauss) 40	LA	1	1
4 ER Medium Lasers	LT	4	4
Battle Value: 2,156			

**Weapons and Ammo Location Critical Tonnage**
*Alternate Configuration H*

Ultra A/C10	RA	4	10
Ammo (Ultra) 20	RA	2	2
Heavy Large Laser	LA	3	4
2 ER Medium Lasers	LA	2	2
LRM 10	LT	1	2.5
Ammo (LRM) 12	LT	1	1
Battle Value: 2,185			

*Alternate Configuration M*

HAG 20	RA	6	10
Ammo (HAG) 18	RT	3	3
ER PPC	LA	2	6
3 SRM 2	LT	3	1.5
Ammo (SRM) 50	LT	1	1
Battle Value: 2,182			

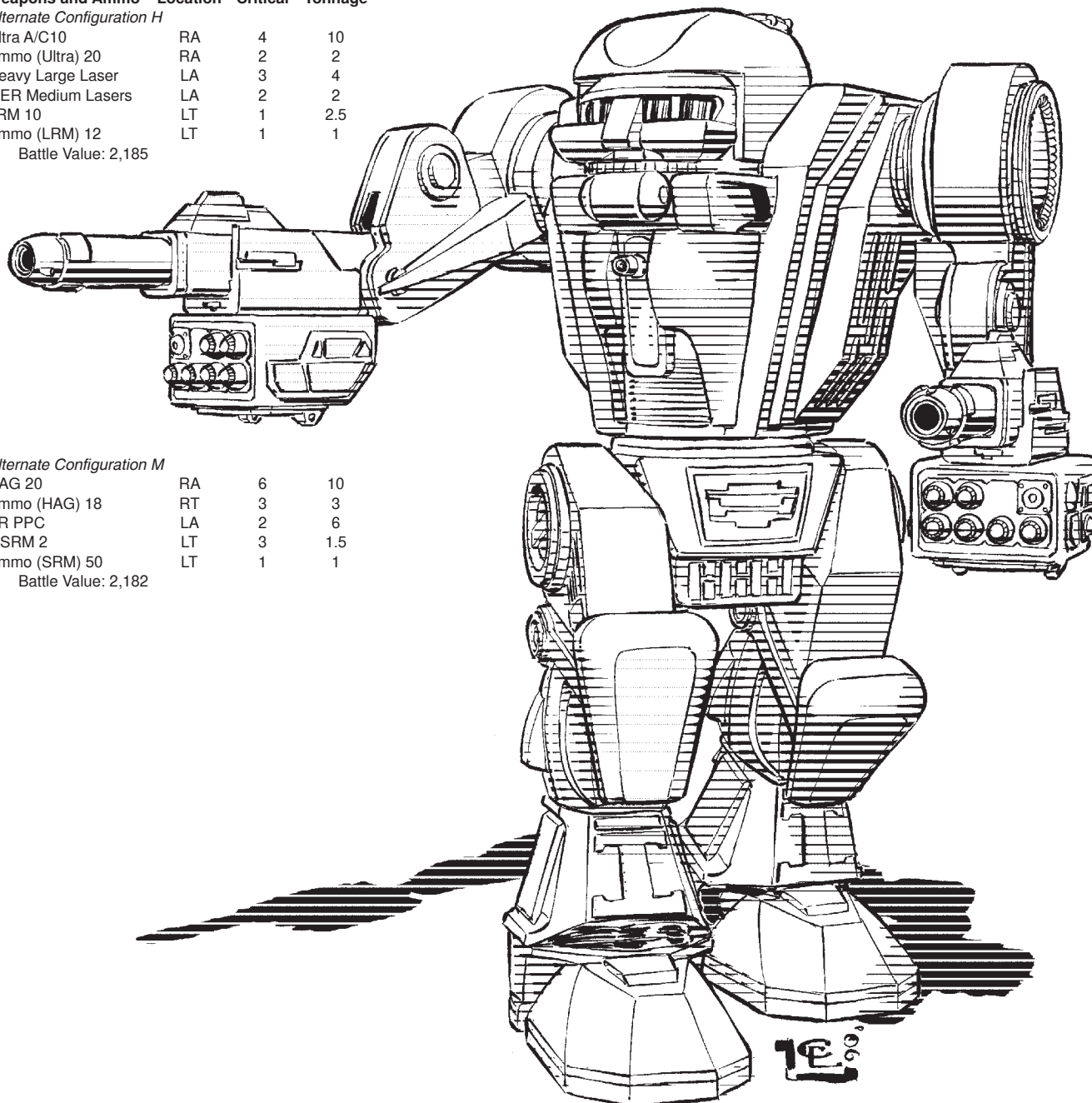

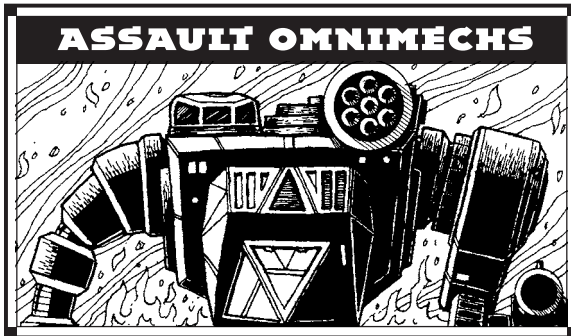

**Mass:** 85 tons  
**Chassis:** Huntress WH  
**Power Plant:** General Systems 340 XL  
**Cruising Speed:** 43 kph  
**Maximum Speed:** 64 kph  
**Jump Jets:** None  
**Jump Capacity:** None  
**Armor:** Forging X85 Ferro-Fibrous  
**Armament:**  
 32.5 tons of pod space available  
**Manufacturer:** Phan Industrialplex  
**Primary Factory:** Huntress  
**Communications System:** Series 10 CBS MultiFreq  
**Targeting and Tracking System:** HawkEye J360

## Overview

Introduced at the turn of the century, the *Warhawk*, or *Masakari* as it is known by the Inner Sphere, was created by the Smoke Jaguars in anticipation of the Clans' return to the Inner Sphere. The Dragoon Compromise temporarily derailed such plans, but left Smoke Jaguar MechWarriors in possession of one of the most advanced BattleMechs ever created.

## Capabilities

The *Masakari* is a deadly machine. With a squat and boxy torso, aesthetics clearly were not high on the Jaguar Scientist Caste's list of priorities. The Primary configuration is well suited to the assault role with its four ER PPCs. Configuration A carries a more diverse mix of missiles, autocannon, and lasers that make heat management easier. The *Masakari*'s one real weakness is illustrated in the B configuration. With ferro-fibrous armor and a generous twenty heat sinks, it is a real challenge finding somewhere

to mount weapons the size of a Gauss rifle; the other weapons have been squeezed in anywhere they will fit. Configuration C is an attempt to deal with the chronic heat problems suffered in the Primary configuration. Replacing two of the ER PPCs with large pulse lasers alleviates some of the issues, but even this is not quite enough.

Introduced in the years since the Clans were halted at Tukayyid, the D, E, and H configurations mount new Clan weapons. Configuration D carries an ATM launcher as part of a weapons array that finally manages to balance heat and firepower, while configuration H was introduced by the Star Adders to put their heavy lasers in the field. Most recently, the Fire Mandrills have introduced the E configuration. The paired ER PPC and large pulse laser are normal enough, but the triple plasma cannons are a surprising deviation from established tactical doctrine.

## Deployment

Introduced in 2999, the *Masakari* was part of the Jaguar military buildup in anticipation of the return to the Inner Sphere. When the Dragoon Compromise stalled plans for invasion, the Smoke Jaguars unleashed their new weapon on the Warden Clans who had stymied them. The *Masakari* was deployed extensively in Jaguar frontline forces and was often paired with the *Daishi*.

Following the Jaguars' annihilation, the Fire Mandrills seized control of the Phan Industrialplex on Huntress. Inner Sphere forces had made a cursory effort to raze the complex, so enough survived to rebuild one *Masakari* production line. The Mandrills have also traded the design to the Diamond Sharks, and the Goliath Scorpions appear to have a source of new *Masakar*s, possibly from their Abysmal Manufacturing Complex.

Over the years the other Clans have captured a small number of *Masakar*s. These OmniMechs are highly prized, and great pains are taken to keep them in perfect condition.

## Notable MechWarriors

**Star Colonel Ranna Kerensky:** Genetically descended from Khan Natasha Kerensky, Ranna had the honor of winning the Black Widow's Bloodname following the Refusal War. Just as aggressive and deadly as her legendary predecessor, Ranna commands the Fourth Wolf Guards in the Clan Wolf (in-Exile)'s Alpha Galaxy.

Type: **Warhawk**  
 Inner Sphere Designation: **Masakari**  
 Technology Base: Clan OmniMech  
 Tonnage: 85  
 Battle Value: 3,252

Equipment		Mass
Internal Structure:		8.5
Engine:	340 XL	13.5
Walking MP:	4	
Running MP:	6	
Jumping MP:	0	
Heat Sinks:	20 [40]	10
Gyro:		4
Cockpit:		3
Armor Factor:	259	13.5
	<i>Internal Structure</i>	<i>Armor Value</i>
Head	3	9
Center Torso	27	42
Center Torso (rear)		10
R/L Torso	18	26
R/L Torso (rear)		10
R/L Arm	14	28
R/L Leg	18	36

Weight and Space Allocation		
Location	Fixed	Spaces Remaining
Head	1 Ferro-Fibrous	0
Center Torso		2
Right Torso	2 XL Engine Double Heat Sink	6
Left Torso	2 XL Engine 4 Double Heat Sinks 2 Ferro-Fibrous	0
Left Arm	1 Ferro-Fibrous	7
Right Arm	1 Ferro-Fibrous	7
Right Leg	Double Heat Sink	0
Left Leg	Double Heat Sink	0

Weapons and Ammo	Location	Critical	Tonnage
<i>Primary Weapons Configuration</i>			
2 ER PPC	RA	4	12
Targeting Computer	RT	5	5
2 ER PPC	LA	4	12
LRM 10	LA	1	2.5
Ammo (LRM) 12	LA	1	1

<i>Alternate Configuration A</i>			
LB 10-X AC	RA	5	10
Ammo (LB-X) 20	RA	2	2
Ammo (LRM) 8	RA	1	1
LRM 15	RT	2	2.5
Targeting Computer	RT	4	4
2 ER Large Lasers	LA	2	8
Streak SRM 6	LA	2	3
Ammo (Streak) 15	LA	1	1
Battle Value: 2,399			

**Weapons and Ammo Location Critical Tonnage**

*Alternate Configuration B*

3 ER Medium Lasers	RA	3	3
Ammo (SRM) 75	RA	5	5
Targeting Computer	RT	4	4
2 SRM 6	RT	2	3
Gauss Rifle	LA	6	12
Ammo (Gauss) 16	LA	2	2
ER Small Laser	LA	1	.5
Narc Missile Beacon	CT	1	2
Ammo (Narc) 6	CT	1	1
Battle Value: 2,320			

*Alternate Configuration C*

2 Large Pulse Lasers	RA	4	12
Double Heat Sink	RA	2	1
Targeting Computer	RT	5	5
2 ER PPCs	LA	4	12
2 Double Heat Sinks	LA	4	2
Flamer	CT	1	.5
Battle Value: 2,998			

*Alternate Configuration D*

Ultra AC/10	RA	4	10
Ammo (Ultra) 20	RA	2	2
2 ER Large Lasers	RT	2	8
Targeting Computer	RT	4	4
ATM 9	LA	4	5
Ammo (ATM) 21	LA	3	3
ER Small Laser	CT	1	.5
Battle Value: 2,476			

*Alternate Configuration E*

ER PPC	RA	2	6
Large Pulse Laser	RA	2	6
Targeting Computer	RT	5	5
3 Plasma Cannons	LA	3	9
Ammo (Plasma) 40	LA	4	4
SRM 6	LA	1	1.5
Ammo (SRM) 15	LA	1	1
Battle Value: 2,895			

*Alternate Configuration H*

2 Large Pulse Lasers	RA	4	12
LRM 10	RA	1	2.5
Ammo (LRM) 12	RA	1	1
Double Heat Sink	RA	2	1
Double Heat Sink	RT	2	1
Targeting Computer	RT	4	4
2 Heavy Large Lasers	LA	6	8
Double Heat Sink	LA	2	1
Double Heat Sink	CT	2	1
Battle Value: 2,601			

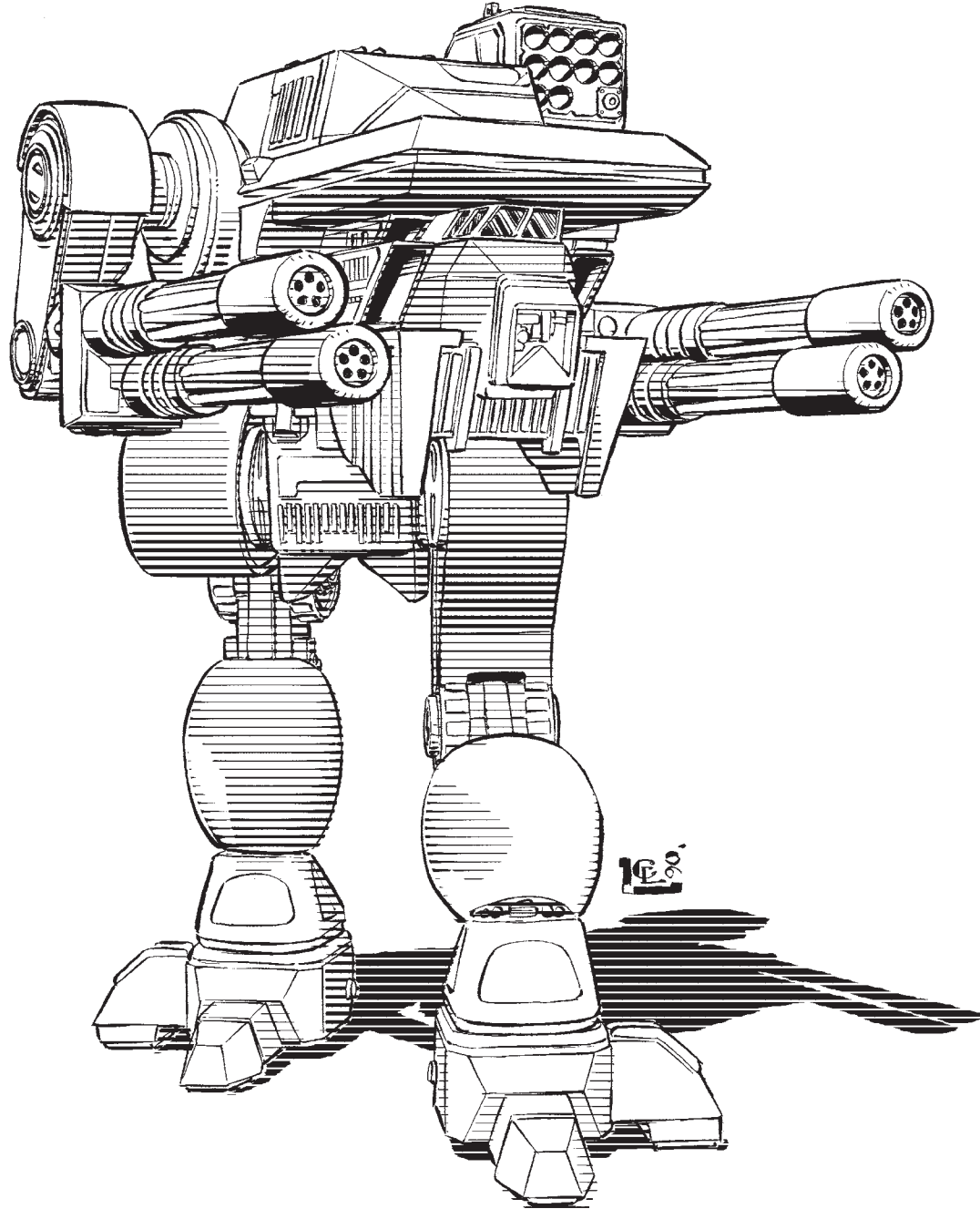

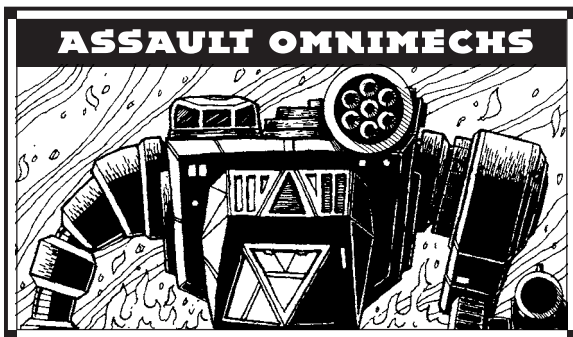

**Mass:** 95 tons

**Chassis:** Clan Series Assault SXE

**Power Plant:** 380 Heavy Force XL

**Cruising Speed:** 43 kph

**Maximum Speed:** 64 kph, 86 kph w/MASC

**Jump Jets:** Pryzhok WM 10

**Jump Capacity:** 120 meters

**Armor:** Arcadia Compound Delta VII Ferro-Fibrous

**Armament:**

26.5 tons of pod space available

**Manufacturer:** Alshain BattleWorx

**Primary Factory:** Alshain

**Communications System:** Dash-2 Optima

**Targeting and Tracking System:** Hakkør-Morris LAP

## Overview

Acquired in some long-forgotten Trial against Clan Burrock, the plans for the 95-ton *Executioner*—known as the *Gladiator* in the Inner Sphere—underwent several revisions by Ghost Bear scientists. The original plan was to merge the *Burrock* design with the *Kodiak* (then in development), creating an OmniMech that would espouse the Clan's totem as a symbol of Bear power.

Unfortunately, the structural deficiencies of the *Kodiak* prohibited the inclusion of MASC circuitry on the design—eighteen of twenty trials failed. Rather than scrap the *Gladiator*, however, Clan scientists suggested that resources be made available to design two assault 'Mech platforms—one as a powerful OmniMech and another as a second-line unit championing the Bear warrior spirit.

Once the Clan Council gave their approval, development on the *Gladiator* proceeded swiftly, and the first walked from the Arcadian factory within three years.

## Capabilities

Slightly underpowered compared to other Clan assault machines, the *Gladiator* still finds favor with Ghost Bear warriors due to its speed (topping out near 90 kph) and balance. Four Pryzhok jump jets give an extra edge of mobility, which was demonstrated in the *Gladiator's* first Trial of Possession. Eager to acquire the design, Hell's Horses Star Captain Reginald Amirault neglected the Watch's briefing on the new design and was astounded when Star Commander Gorman Bekker jumped his *Gladiator* behind Amirault's *Mad Cat*, which was eviscerated with one targeted weapons volley.

Most initial configurations for the *Gladiator* are still in service, though the D version seems to have fallen into disuse except as a trainer. Two new configurations—the K and P—field massive HAG weapons and laser arrays and have become so popular among younger warriors that the Ghost Bears are scrambling to negotiate for more HAGs from Diamond Shark merchants to meet demand.

## Deployment

During the first few decades of its deployment, no Ghost Bear warrior lost a Trial of Possession that involved the *Gladiator* as the Trial's target. Due more to the exceptional bond these warriors developed than any stellar weapons loadout, other Clans pressed relentlessly for the design. Soon after Clan Smoke Jaguar finally won a Trial for a Star's worth of the machines, every Clan had access to the *Gladiator*. However, most Clans were unable to fully exploit the assault design's capabilities (the Jaguars and Burrocks are notable exceptions); the Ghost Bears are the only Clan known to still produce and field the design in large numbers.

## Notable MechWarriors

**Star Commander Gorman Bekker:** In service to the Golden Keshik for a stunning twenty-two years, Bekker accounted for eighteen Trial victories against fourteen Clans, all over the *Gladiator* or its production site. Bekker died from a massive brain aneurysm in the middle of his nineteenth Trial against the Smoke Jaguars. Refusing to recognize that a natural malady would claim such a fierce warrior, the Jaguars honored Bekker's legacy by including a small statue of him at their genetic repository, an unheard of recognition.

Type: **Executioner**

Inner Sphere Designation: **Gladiator**

Technology Base: Clan OmniMech

Tonnage: 95

Battle Value: 2,619

## Equipment

		Mass
Internal Structure:		9.5
Engine:	380 XL	20.5
Walking MP:	4	
Running MP:	6 (8)	
Jumping MP:	4	
Heat Sinks:	16 [32]	6
Gyro:		4
Cockpit:		3
Armor Factor:	259	13.5
	<i>Internal Structure</i>	<i>Armor Value</i>
Head	3	9
Center Torso	30	37
Center Torso (rear)		9
R/L Torso	20	20
R/L Torso (rear)		10
R/L Arm	16	32
R/L Leg	20	40

## Weight and Space Allocation

Location	Fixed	Spaces Remaining
Head	1 Ferro-Fibrous	0
Center Torso	2 Ferro-Fibrous	0
Right Torso	2 XL Engine	6
	1 Double Heat Sink	
	2 Ferro-Fibrous	
Left Torso	2 XL Engine	6
	4 MASC	
Left Arm	1 Ferro-Fibrous	7
Right Arm	1 Ferro-Fibrous	7
Right Leg	2 Jump Jets	0
Left Leg	2 Jump Jets	0

## Weapons and Ammo Location Critical Tonnage

### Primary Weapons Configuration

2 ER Large Lasers	RA	2	8
2 Double Heat Sinks	RA	4	2
2 Machine Guns	RT	2	.5
Ammo (MG) 200	RT	1	1
Gauss Rifle	LA	6	12
Double Heat Sink	LA	2	1
Ammo (Gauss) 16	LT	2	2

**Weapons and Ammo Location Critical Tonnage**

*Alternate Configuration A*

4 ER Medium Lasers	RA	4	4
2 Double Heat Sinks	RA	4	2
2 Machine Guns	RT	2	.5
Ammo (MG) 200	RT	1	1
3 Large Pulse Lasers	LA	6	18
Double Heat Sink	LA	2	1
Battle Value: 2,953			

*Alternate Configuration B*

ER PPC	RA	2	6
3 Double Heat Sinks	RA	4	2
Anti-Missile System	RT	1	.5
Ammo (AMS) 24	RT	1	1
ER Medium Laser	RT	1	1
Ultra AC/20	LA	8	12
Ammo (Ultra) 15	LT	3	3
Battle Value: 2,800			

*Alternate Configuration C*

Ultra AC/20	RA	8	12
Ammo (Ultra) 15	RT	3	3
Targeting Computer	RT	3	3
LRM 20	LA	4	5
Artemis IV FCS	LA	1	1
Ammo (LRM) 12	LA	2	2
ER Small Laser	LT	1	.5
Battle Value: 2,610			

*Alternate Configuration D*

Large Pulse Laser	RA	2	6
3 Medium Pulse Lasers	RA	3	6
3 Small Pulse Lasers	RA	3	3
2 Small Pulse Lasers	RT	2	2
2 Double Heat Sinks	RT	4	2
2 SRM 6	LA	2	3
Ammo (SRM) 45	LA	3	3
ER Small Laser	LT	1	.5
Double Heat Sink	LT	4	2
Battle Value: 2,572			

*Alternate Configuration E*

2 ER Large Lasers	RA	2	8
Double Heat Sink	RA	2	1
2 Heavy Medium Lasers	RT	4	2
Heavy Small Laser	RT	1	.5
2 ATM 9	LA	8	10
Ammo (ATM) 35	LT	5	5
Battle Value: 2,838			

**Weapons and Ammo Location Critical Tonnage**

*Alternate Configuration H*

Heavy Large Laser	RA	3	4
2 ER Medium Lasers	RT	2	2
Targeting Computer	RT	4	4
Ultra AC/20	LA	8	12
Ammo (Ultra) 20	LT	4	4
Flamer	LT	1	.5
Battle Value: 2,904			

*Alternate Configuration K*

2 ER Large Lasers	RA	2	8
3 ER Medium Lasers	RA	3	3
Light Active Probe	RT	1	.5
Double Heat Sink	RT	2	1
HAG 20	LA	6	10
Ammo (HAG) 18	LA	3	3
Double Heat Sink	LT	2	1
Battle Value: 2,967			

*Alternate Configuration P*

HAG 30	RA	8	13
Ammo (HAG) 12	RT	3	3
LRM 10	RT	1	3.5
Ammo (LRM) 12	RT	1	1
Plasma Cannon	LA	1	3
Ammo (Plasma) 10	LA	1	1
3 Heavy Medium Lasers	LT	6	3
Battle Value: 2,898			

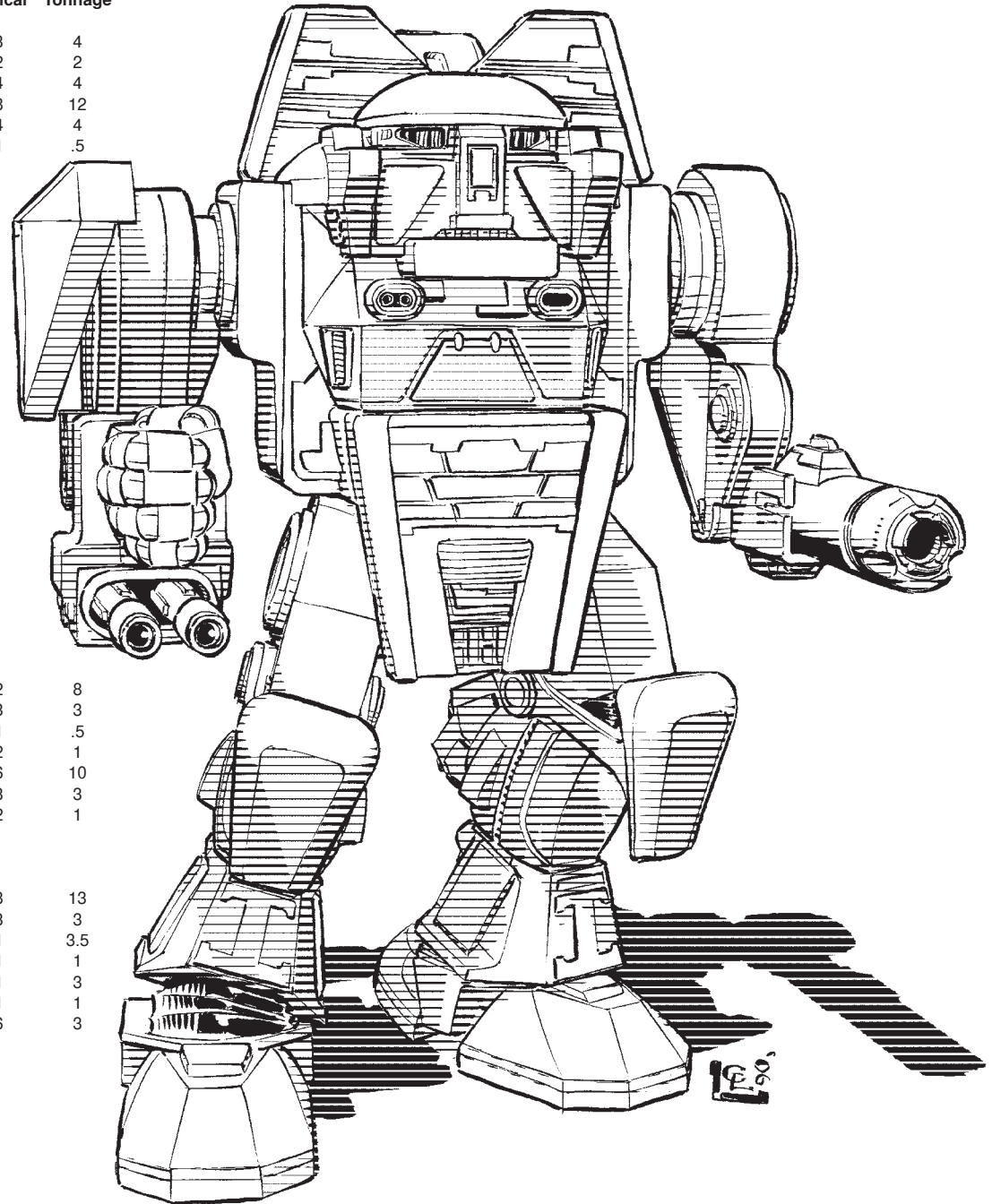

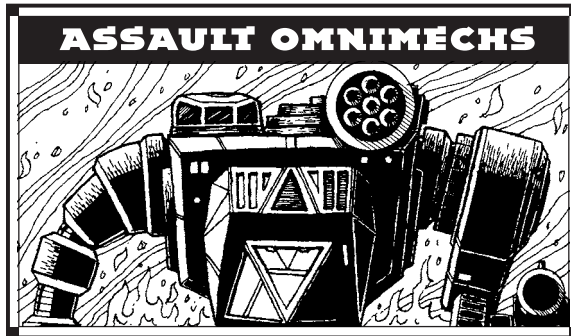

**Mass:** 100 tons  
**Chassis:** Titan HX  
**Power Plant:** Starfire 300 XL  
**Cruising Speed:** 32 kph  
**Maximum Speed:** 54 kph  
**Jump Jets:** None  
**Jump Capacity:** None  
**Armor:** Compound 12B2 Standard  
**Armament:**  
 50.5 tons of pod space available  
**Manufacturer:** Wolf Clan Site #1  
**Primary Factory:** Strana Mechty  
**Communications System:** TJ6 "Bell" Integrated Communication System  
**Targeting and Tracking System:** Mars System 9

## Overview

The *Dire Wolf* (or *Daishi*, as it is known to the Inner Sphere) was still on Clan Wolf drawing boards when Smoke Jaguar warriors learned of the creation of the "Ultimate Assault OmniMech." Knowing they had to have it for themselves, the Jaguars declared a Trial of Possession (in which the Jaguars danced on boundaries of zellbrigen) and wrestled the design from the Wolves' jaws.

The *Daishi* came off the Huntress production lines in 3010 and was manufactured until Inner Sphere forces razed the Phan Industrialplex in 3060.

## Capabilities

All considerations are secondary to pod space for the *Daishi*, allowing the OmniMech to carry massive armament. Armed with bundles of lasers and autocannons, the Primary configuration carries awesome firepower. The A and B configurations lack the same punch but manage heat more efficiently. The Wolves introduced the S configuration for urban combat in the Inner Sphere.

Clan Coyote add their ATM launchers on configuration C, but limited magazines further hinder that weapon's over-hyped flexibility. The Star Adders enjoyed more success pairing their heavy lasers with Gauss rifles to create the deadly configuration H. Few OmniMechs can mount the Hell's Horses HAG 40, but only the *Daishi* can mount two. Even then, configuration D has limited secondary weaponry.

Wolf's Dragoons configuration W is used in their training command and on the battlefield. Armed with a mix of weapons, it is deadly at all ranges.

## Deployment

Before their annihilation, the Smoke Jaguars employed many *Daishis*, with which they smashed through their enemy's lines.

After losing the design to the Jaguars, the Wolves honor demanded action, but a Trial of Refusal would have compelled the proud Jaguars to escalate the conflict. Instead, Star Colonel Ulric initiated a Trial of Possession only for the rights to manufacture the *Daishi*, which he won in 3019.

Other Clans could only acquire the deadly OmniMech through trade or as isorla. Using technical information provided by Khan Kerlin Ward, Wolf's Dragoons began manufacturing *Daishis* on Outreach in the late 3040s.

## Notable MechWarriors

**Khan Natasha Kerensky:** Known as the Black Widow, Natasha Kerensky returned to Clan Wolf after spending decades in the Inner Sphere with Wolf's Dragoons. Proving herself as deadly as ever, Natasha passed a new Trial of Position with four kills, earning the right to form the Thirteenth Wolf Guard.

The Black Widow finally fell in battle, single-handedly holding the Great Gash on Twycross against the Falcon Guard.

**Precentor Martial Victor Steiner-Davion:** One of the greatest military commanders the Inner Sphere has seen since Aleksandr Kerensky, Victor has handed the Clans a string of defeats, culminating in the annihilation of the Smoke Jaguars and the destruction of the Crusader cause in the Great Refusal on Strana Mechty. Returning to the Inner Sphere, Victor then had to liberate the Federated Suns and Lyran Alliance from the tyrannical rule of Katherine, his sister. Victor now faces the challenge of rallying a divided Inner Sphere against the Word of Blake.

Type: **Dire Wolf**

Inner Sphere Designation: **Daishi**  
 Technology Base: Clan OmniMech  
 Tonnage: 100  
 Battle Value: 2,712

## Equipment

		Mass
Internal Structure:		10
Engine:	300 XL	9.5
Walking MP:	3	
Running MP:	5	
Jumping MP:	0	
Heat Sinks:	15 [30]	5
Gyro:		3
Cockpit:		4
Armor Factor:	304	19
	<i>Internal Structure</i>	<i>Armor Value</i>
Head	3	9
Center Torso	31	47
Center Torso (rear)		14
R/L Torso	21	32
R/L Torso (rear)		10
R/L Arm	17	34
R/L Leg	21	41

## Weight and Space Allocation

Location	Fixed	Spaces Remaining
Head	None	1
Center Torso	None	2
Right Torso	2 XL Engine Double Heat Sink	8
Left Torso	2 XL Engine Double Heat Sink	8
Left Arm	None	8
Right Arm	None	8
Right Leg	None	2
Left Leg	Double Heat Sink	0

## Weapons and Ammo

Location	Critical	Tonnage
<i>Primary Weapons Configuration</i>		
2 ER Large Lasers	2	8
2 Medium Pulse Lasers	2	4
Ultra AC/5	3	7
Ammo (Ultra) 20	1	1
3 Double Heat Sinks	6	3
2 ER Large Lasers	2	8
2 Medium Pulse Lasers	2	4
Ultra AC/5	3	7
Ammo (Ultra) 20	1	1
LRM 10	1	2.5
Ammo (LRM) 12	1	1
3 Double Heat Sinks	6	3
Double Heat Sink	2	1



**Weapons and Ammo Location Critical Tonnage**
*Alternate Configuration A*

3 Large Pulse Lasers	RA	6	18
Double Heat Sink	RA	2	1
AMS	RT	1	.5
Ammo (AMS) 72	RT	3	3
2 Double Heat Sinks	RT	4	2
Gauss Rifle	LA	6	12
Ammo (Gauss) 24	LA	3	3
2 Streak 6	LT	4	6
Ammo (Streak) 30	LT	2	2
Double Heat Sink	LT	2	1
Double Heat Sink	CT	2	1
Double Heat Sink	RL	2	1
Battle Value: 2,896			

*Alternate Configuration B*

LB 10-X AC	RA	5	10
Ammo (LB-X) 20	RA	2	2
2 Ultra AC/2	RT	4	10
Ammo (Ultra) 45	RT	1	1
2 ER PPCs	LA	4	12
2 Medium Pulse Lasers	LA	2	4
2 Ultra AC/2	LT	4	10
Ammo (Ultra) 45	LT	1	1
ER Small Laser	CT	1	.5
Battle Value: 2,609			

*Alternate Configuration C*

ER PPC	RA	2	6
ATM 6	RA	3	3.5
Ammo (ATM) 10	RA	1	1
2 Double Heat Sinks	RA	4	2
Medium Pulse Laser	RT	1	2
Targeting Computer	RT	4	4
Double Heat Sink	RT	2	1
Jump Jet	RT	1	2
ER PPC	LA	2	6
ATM 6	LA	3	3.5
Ammo (ARM) 10	LA	1	1
2 Double Heat Sinks	LA	4	2
3 Medium Pulse Lasers	LT	3	6
2 Double Heat Sinks	LT	4	2
Jump Jet	LT	1	2
Streak SRM 4 (OS)	H	1	2.5
Jump Jet	CT	1	2
ECM Suite	CT	1	1
Double Heat Sink	RL	2	1
Battle Value: 3,610			

*Alternate Configuration D*

HAG 40	RA	10	16
Ammo (HAG) 15	RT	5	5
HAG 40	LA	10	16
Ammo (HAG) 15	LT	5	5
Streak SRM 6	LT	2	3
Ammo (Streak) 15	LT	1	1
ER Small Laser	H	1	.5
2 Medium Pulse Lasers	CT	2	4
Battle Value: 3,403			

**Weapons and Ammo Location Critical Tonnage**
*Alternate Configuration H*

Heavy Large Laser	RA	3	4
Gauss Rifle	RA	6	12
Ammo (Gauss) 8	RA	1	1
Medium Pulse Laser	RT	1	2
Targeting Computer	RT	7	7
Gauss Rifle	LA	6	12
Ammo (Gauss) 8	LA	1	1
Heavy Large Laser	LA	3	4
Ammo (Gauss) 16	LT	2	2
3 Double Heat Sinks	LT	6	3
Flamer	H	1	.5
Double Heat Sink	CT	2	1
Double Heat Sink	RL	2	1
Battle Value: 2,992			

*Alternate Configuration S*

LB 20-X AC	RA	9	12
Ammo (LB-X) 5	RA	1	1
Ammo (LB-X) 15	RT	3	3
2 Medium Pulse Lasers	RT	2	4
Machine Gun	RT	1	.25
Ammo (MG) 200	RT	1	1
Jump Jet	RT	1	2
Large Pulse Laser	LA	2	6
4 Double Heat Sinks	LA	8	4
2 Medium Pulse Lasers	LT	2	4
Machine Gun	LT	1	.25
Streak SRM 4	LT	1	2
Ammo (Streak) 25	LT	1	1
Double Heat Sink	LT	2	1
Jump Jet	LT	1	2
Medium Pulse Laser	H	1	2
Streak SRM 4	CT	1	2
Jump Jet	CT	1	2
2 A-Pods	RL	2	1
Battle Value: 2,985			

*Alternate Configuration W*

ER Large Laser	RA	1	4
4 Double Heat Sinks	RA	8	4
Ultra AC/20	RT	10	12
Gauss Rifle	LA	6	12
Ammo (Gauss) 32	LA	4	4
LRM 20	LT	4	5
Ammo (LRM) 12	LT	2	2
Ammo (Ultra) 10	LT	2	2
ER Small Laser	H	1	.5
2 Medium Pulse Lasers	CT	2	4
Double Heat Sink	RL	2	1
Battle Value: 2,951			

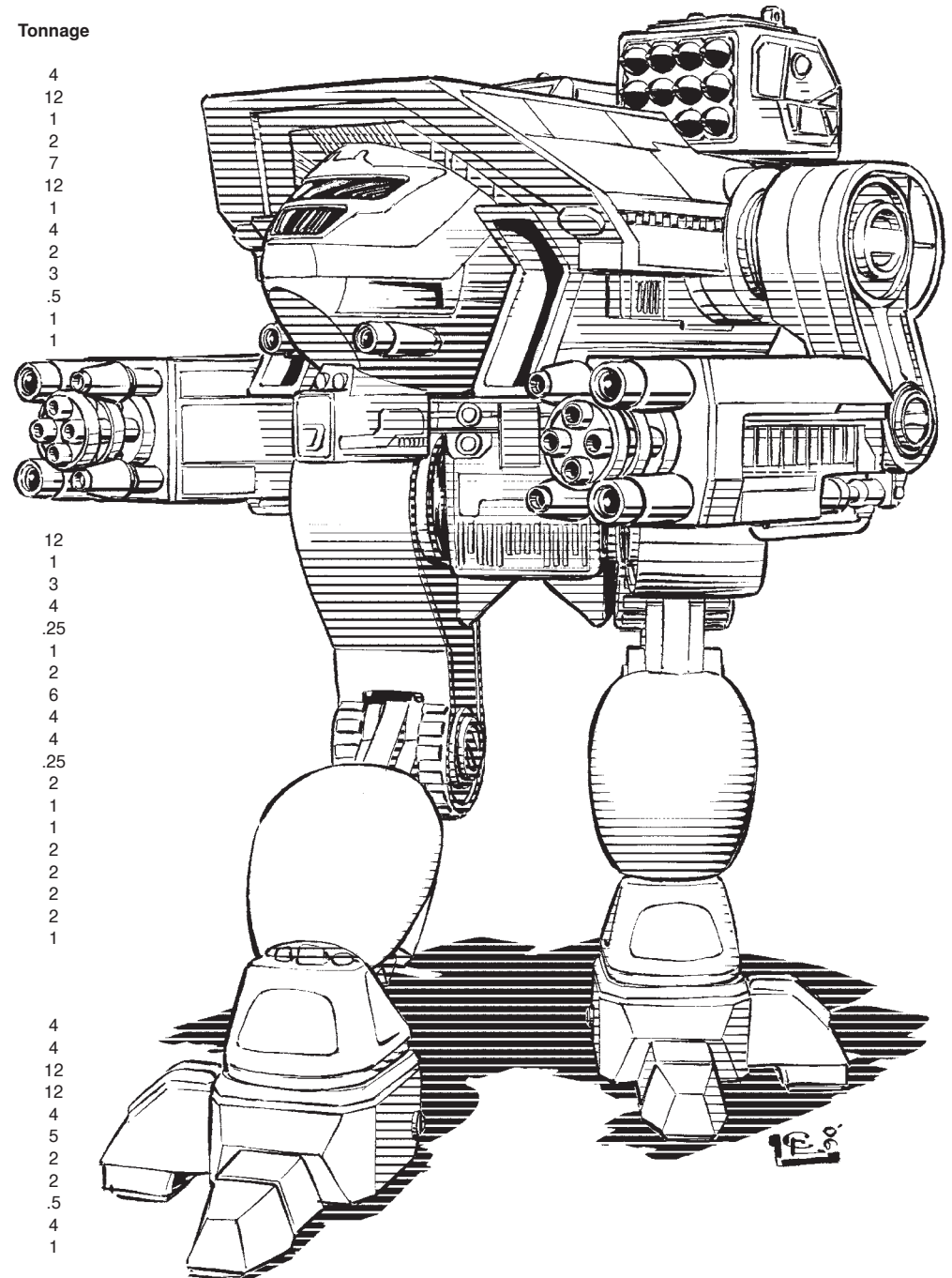



**T**he Star League made great strides in all areas of military technology. Improvements in weaponry, armor, and manufacturing techniques created deadly fighting machines that were faster, better armed, and better protected. Access to this technology was strictly controlled. The SLDFs Royal commands—units drawing personnel exclusively from the Terran Hegemony—were the first to receive the latest technology. The less prestigious SLDF line regiments, comprising personnel from all the League member states, had to wait years before they received the same equipment. Member states would often have to wait decades before the Hegemony provided the technical details needed to produce such equipment. With the collapse of the first Star League in 2781, the five Great Houses received a massive technological windfall. Many of the SLDF troops who did not follow General Aleksandr Kerensky into the Periphery retained their equipment. The absorption of former Hegemony worlds garnered the House Lords supplies, designs, and the manufacturing base to produce more. But then the First and Second Succession Wars shattered the Inner Sphere's industrial base. Supply caches were exhausted. Too many skilled technicians had died on the front trying to keep the remaining machines in operation. The Successor Lords had no choice but to use older, obsolescent technologies in their war machines. The few remaining Star League designs only remained operational because their advanced systems had long since been replaced by simple (but readily available) equipment.

By the end of the Third Succession War, the Great Houses thought Star League technology lost. But unknown to them, ComStar had inherited vast caches of advanced technology when it seized Terra in 2788. Following the Fourth Succession War, ComStar announced the formation of a military force to guard its HPGs. The hidden stores allowed the Com Guards to rapidly grow into a force fielding more than four thousand BattleMechs with armor and infantry support. ComStar also used its store of equipment to secretly re-arm the Draconis Combine—though not before stripping out most of the advanced technology.

Deep in the Periphery the Clans also possess Star League equipment. Upon reaching the Pentagon Worlds, General Aleksandr Kerensky demobilized seventy five percent of his troops and excess equipment was stored away in “Brian Caches”. Some were looted during the Pentagon Civil War, but many survived intact. The Clans tapped this store of material, sometimes using Star League equipment as the basis for upgraded designs. As new and even more advanced weapons were developed, Star League equipment that had survived years of inter-Clan trials was once more consigned to the depths of the Brian Caches. Only training commands and *solahma* (collections of old and disgraced warriors) are outfitted with these obsolete 'Mechs and aerospace fighters today. Clan armor formations (often treated little better than *solahma*) also make use of vintage SLDF equipment.

Thanks to the Gray Death Legion's discovery of a Star League computer library core on Helm in 3028, much lost knowledge has been recovered and the Inner Sphere nations have started manufacturing a number of old Star League designs.

[EDITOR'S NOTE: A final note on this dossier of original Star League-era military equipment and the differences when compared to that presented in the *Technical Readout: 2750* document published decades ago. If no variant of a military vehicle (i.e. 'Mech, vehicle or aerospace fighter) is currently in production, the performance statistics of the original 2750 configuration (as detailed in the *Technical Readout: 2750* document) are presented here. If a military vehicle is currently in production in its original 2750 configuration, that is the version presented here. Finally, there are a few instances where the original variant is no longer produced, but a different/new variant is in production. In this case, the variant currently moving off assembly lines is detailed. Field commanders are more likely to run into such designs, hence the importance of detailing that information.]

—Captain Ignatius Smith  
Intelligence and Analysis, Wolfnet  
21 November 3071

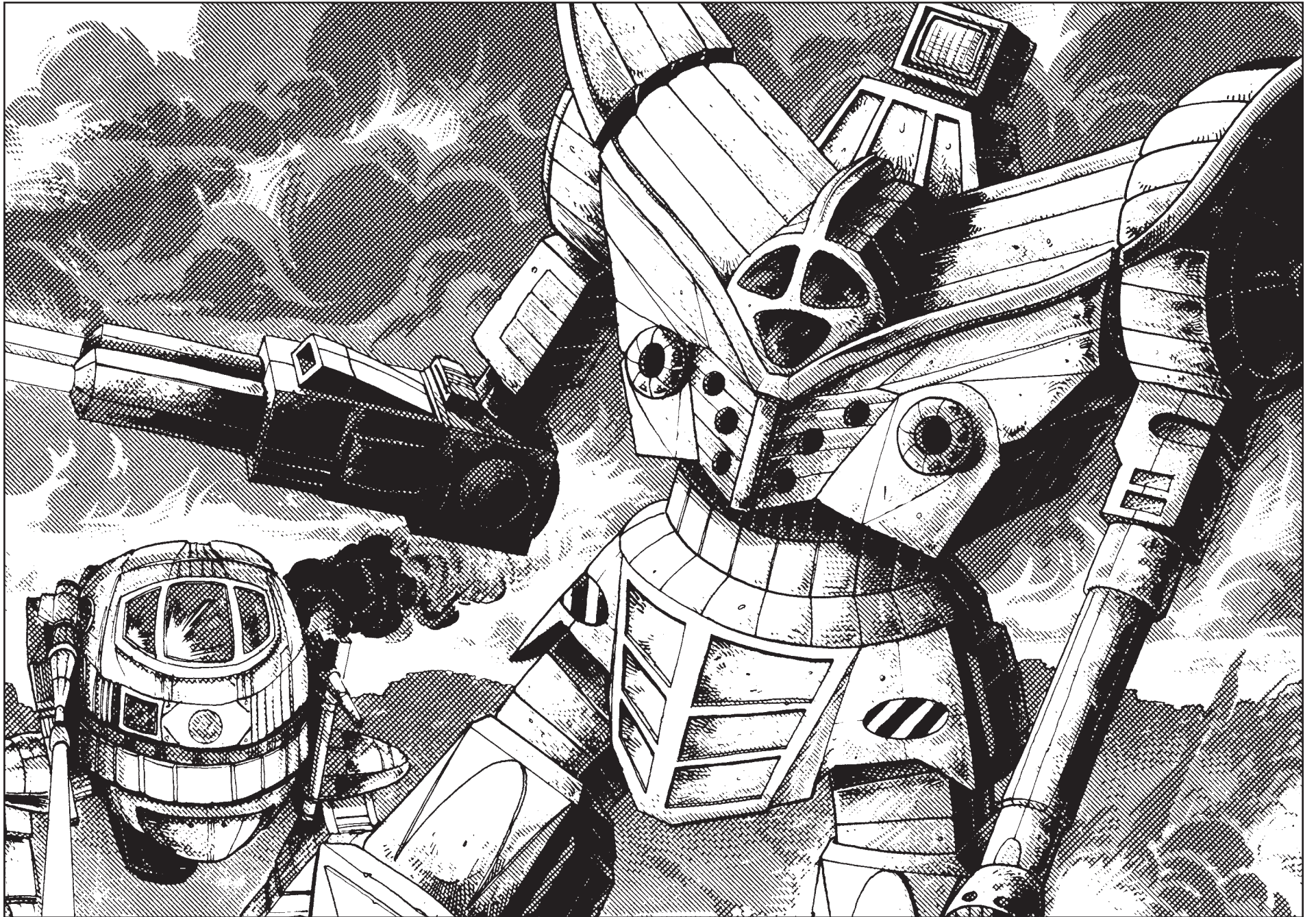

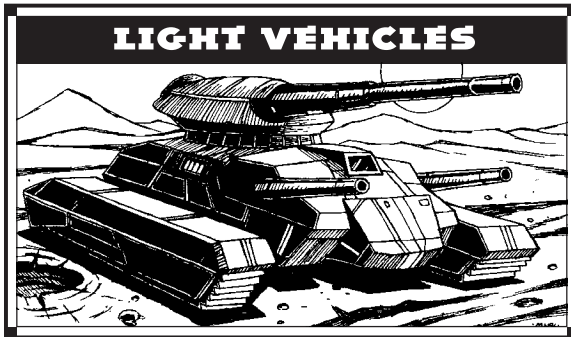

**Mass:** 5 tons

**Movement Type:** Hovercraft

**Power Plant:** VOX 25

**Cruising Speed:** 140 kph

**Flank Speed:** 216 kph

**Armor:** Bowie Ferro-Fibrous

**Armament:**

1 Maxwell TR Medium Laser

**Manufacturer:** Bowie Industries

**Primary Factory:** Terra

**Communications System:** CBR CommSat

**Targeting and Tracking System:** Halo 901

## Overview

A highly advanced reconnaissance hovercraft designed by Bowie for the SLDF, the Gabriel is best known for its automatic turret controls. During the heyday of the Golden Age, engineers were able to develop a limited AI interface that the single pilot could utilize to automatically engage targets not identified on its IFF system. Incorporating a 360-degree firing arc, the system was extremely versatile—it even allowed the pilot to fine tune the system to fire at specific points or components on a verifiable target.

With advanced miniaturization techniques, engineers were able to reduce the size of the targeting system and increase the engine size, giving the Gabriel an unprecedented land speed of over 250 kph. Enamored with the design as a whole, the SLDF signed Bowie to an exclusivity contract and bought unrecorded numbers of the platform.

Unfortunately, a massive explosion at Bowie's original headquarters building based in Chicago (on Terra) wiped out the sole fabrication point of the sophisticated system and killed the lead project team. To this day, it is still unknown what caused the explosion in the hardened bunker below Lake Michigan.

With the capability of producing such premiere technology in danger of being lost, Bowie engineers attempted reverse engineering the system with current stock, but with limited success. Unable to reproduce the system exactly, the design team scrambled back to the drawing boards in order to revamp the Gabriel so that the SLDF production demands could still be met.

When Terra was closed after Jerome Blake's seizure of the system, Bowie shut down its Gabriel plants and relocated their operational headquarters to Wyatt. Though no new Gabriels were introduced to the Inner Sphere, it has become known that the corporation still manufactured them in some small numbers for ComStar—and subsequently, the Word of Blake. Rumors abound that the nuclear destruction of the Bowie plant on Wyatt was in retaliation for some perceived corporate rebellion by executives against the Word, but no substantial evidence exists to support such a wild theory.

## Capabilities

A standard reconnaissance vehicle, the Gabriel's primary function is to gather intelligence. Used in pairs with Savannah Masters or even light VTOLs, its superior speed allows it to range quickly ahead and stream back information to its command and control center.

The newer variants developed in the Concordat seem to go against this usual tactical doctrine however, with weapons mounted on it more suited to fast-strike harassing platforms. Considering the extremely low cost of these newer Gabriels, it is not surprising that many recon-oriented units have begun fielding them in large numbers, both in the Concordat and in her enemies.

Taurian pilots have re-discovered the Gabriel's trademark sound; pitching the drive fans at a certain angle causes the Gabriel to emit a trumpet-like wail.

It has again become a favored way for the craft to announce their return from patrol.

## Deployment

The Word of Blake-assisted construction of the new Bowie Industries facility on Dicallus has infused many of the Concordat's militias and Corps with a very cheap and fast harasser unit. Outside of this area of space, however, Gabriels remain extremely rare, even among Word of Blake forces.

## Variants

The most predominant variant now in use is classified as a fast-harasser within the TDF. The standard medium laser was removed in order to free up space for two one-shot ten-rack rocket pods. With the advanced targeting system removed—there is no need for it with the fire-and-forget racks—there is a small amount of additional room for the pilot to store some field reconnaissance gear.

A lesser-seen variant replaces the single medium laser with two extended-range small lasers. This variant seems to be attached to militia units stationed in the larger cities of the Concordat. With the cost of any of these variants below 90,000 C-bills, several police and tactical units have begun placing orders for them, much to Bowie's delight.

## Notable Crews

**Privateer Nils "Bastard" Tolin:** Blanketed with a checkered past that includes murder, larceny, and armed robbery, Tolin was thought dead on Spitz after a botched armored car heist in 3063. However, Tolin recently was identified as part of a raiding force operating on the fringe of Concordat space. The pirate band has been flagged as a possible ally of Paula Trevaline, though this remains unconfirmed. Tolin's "wanted" status with the Spitz Security Council has been reinstated, and he is now considered the second-most wanted criminal in the Concordat, with a reward of 2,500,000 Bulls on his head for a confirmed death.

Type: **Gabriel**  
 Technology Base: Inner Sphere  
 Movement Type: Hover  
 Tonnage: 5  
 Battle Value: 198

**Equipment**

		<b>Mass</b>
Internal Structure:		.5
Engine:	25	1.0
Type:	Fusion	
Cruising MP:	13	
Flank MP:	20	
Heat Sinks:	10	0
Control Equipment:		.5
Lift Equipment:		.5
Turret:		.5
Armor Factor:	17	1
	<i>Armor Value</i>	
Front	5	
R/L Side	3/3	
Rear	3	
Turret	3	

<b>Weapons and Ammo</b>	<b>Location</b>	<b>Tonnage</b>
Medium Laser	Turret	1

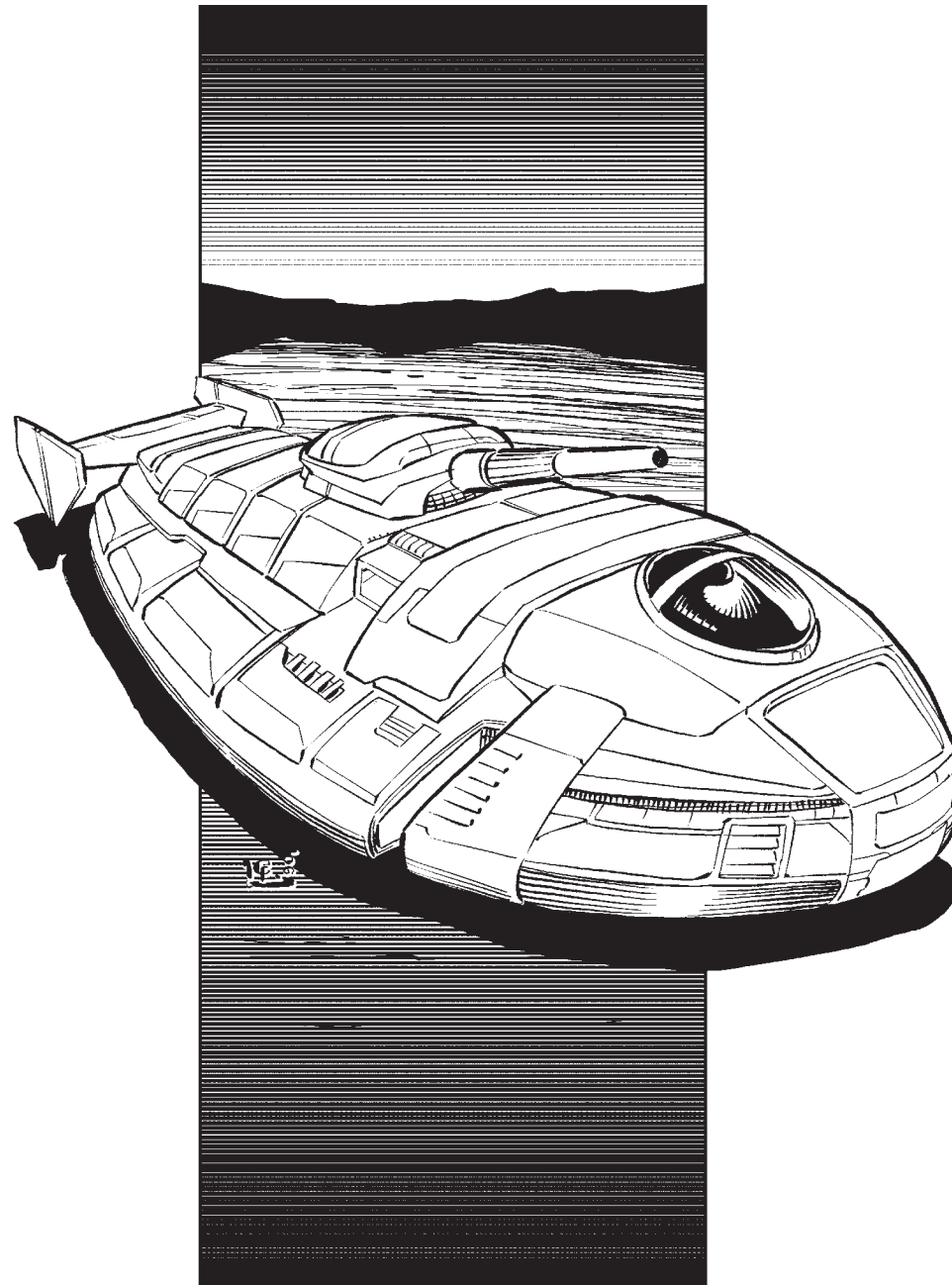

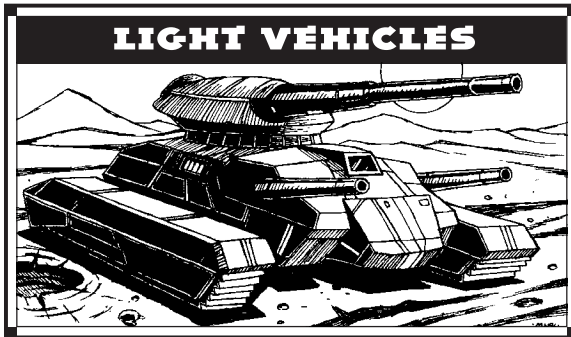

**Mass:** 10 tons

**Movement Type:** VTOL

**Power Plant:** Omni 70

**Cruising Speed:** 129 kph

**Flank Speed:** 194 kph

**Armor:** ProtecTec 6 Ferro-Fibrous

**Armament:**

2 Omicron 950 Medium Lasers

**Manufacturer:** Cal-Boeing

**Primary Factory:** Belladonna

**Communications System:** Datacom 100

**Targeting and Tracking System:** Tarmac Quasar V

## Overview

The Ripper was first produced by Aldis Industries for the Star League in 2680. It was used primarily for delivering a squad of infantry into battle. With the size of the SLDF, this was mainly for special forces or advanced scouts. The fall of the Hegemony to Stefan Amaris spelled the end for the Ripper, as Aldis Industries' VTOL production lines on Terra were destroyed during the Coup. However, Count Douglas Fassei, CEO of Cal-Boeing, won a Star League era data chip containing the Ripper's design specifications in a game of Texas Drax. When the AFFS passed on the design, House Liao purchased a company of Rippers, which were later utilized very effectively by the Death Commandos. Success against Davion forces led to all the Inner Sphere governments seeking Rippers for their elite infantry forces and special operations troops.

## Capabilities

With an Omni 70 fusion engine, the Ripper can reach nearly 200 kph, outrunning a sprinting *Locust*, letting the Ripper rapidly reach its destinations while remaining an elusive target. The problem is that when delivering infantry forces, the Ripper needs to stop. While a ton and a half of ferro-fibrous armor is a good amount for a VTOL, it has to deal with much heavier armed units on the battlefield. Standard operating procedure for the Ripper has been to fire its dual medium lasers at the edges of the landing zone while descending and braking. The infantry are hustled out by the engineer in the infantry compartment, then the craft rises at an angle after the engineer has strapped himself back in. Anything else in the infantry compartment is dumped out. This maximizes the use of the Ripper's speed while decreasing its reliance upon armor and weaponry.

## Deployment

Nearly all the major governments have purchased Rippers, the lone exception being the Free Worlds League. Most of the craft's workload is covert operations or assisting in civilian operations during down times. It can quickly be converted to a rescue unit in times of emergency, and its speed makes it ideal for that job. The Ripper's most notable battlefield exploits came during the Federated Commonwealth Civil War. The planet of Pencader was defended by a regiment of militia infantry with a lance of Rippers that Loki had been using for training. While the 42<sup>nd</sup> Avalon Hussars were attacking Timbiqui, one of their infantry regiments was sent to take Pencader. As the veteran unit moved towards Pencader City, the world's capital, the local militia split along their approach. First the southern half hit the approaching forces, then the northern half attacked as the enemy pulled back. While that fight occurred, the Rippers quickly moved the southern forces to the west, into the path of the Hussars. While they attacked, the Rippers transported the northern troops to the east, where they also launched an attack. Thinking they were besieged by four reinforced battalions, the Hussars surrendered without ever seeing the Rippers.

## Variants

With so many different customers, there are many Ripper variants. A simple modification replaces the medium lasers with ER versions for increased range. Many pilots actually prefer a pair of light pulse lasers or machine guns for use against enemy infantry, which are much harder to spot and avoid. The Draconis Combine even requested a variant with an XL engine so they could mount a light PPC while increasing protection by using heavy ferro-fibrous armor. Cal-Boeing's most demanding job was to design a Ripper that could transport a squad of battle armor for the LAAF. As with the Combine version, Cal Boeing designers used an XL engine and removed the lasers; this only leaves room for one ton of heavy ferro-fibrous armor and a small pulse laser.

## Notable Crews

**Lindy Laws:** Commander of Laws' Flight, a mercenary unit inherited from her mother, Lindy has turned the fortunes of the company around. With a mix of Ripper-Ks and Warriors, Laws' Flight moves toward opponents and drops off their infantry under cover. They then harass the enemy until they come across the hidden anti-mech infantry, who then ambush them.

**The Archangels:** This band of thieves uses their Ripper to help them perform snatch and grabs. They prefer to drop with jump packs to their target, quickly assemble the loot, and then call the Ripper back to retrieve the burglars and their ill-gotten gains. While they usually prefer to rob artwork, cash, precious gems or metals, the Archangels were responsible for selling plans for stealth armor to the Federated Suns.

Type: **Ripper**

Technology Base: Inner Sphere

Movement Type: VTOL

Tonnage: 10

Battle Value: 340

**Equipment**

		<b>Mass</b>
Internal Structure:		1
Engine:	70	3
Type:	Fusion	
Cruising MP:	12	
Flank MP:	18	
Heat Sinks:	10	0
Control Equipment:		.5
Rotor Tonnage:		1
Armor Factor:	26	1.5
	<i>Armor Value</i>	
Front	9	
R/L Side	5/5	
Rear	5	
Rotor	2	

**Weapons and Ammo**

	<b>Location</b>	<b>Tonnage</b>
Medium Laser	Front	1
Medium Laser	Front	1
Infantry Squad	Body	1



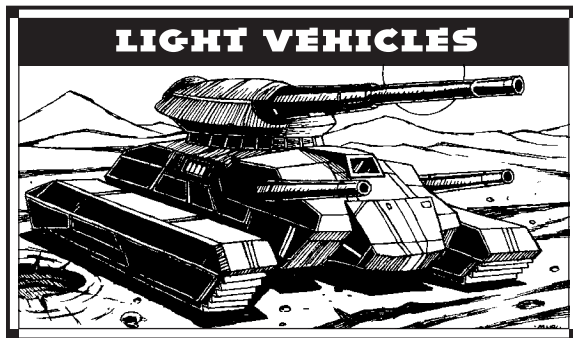

**Mass:** 15 tons  
**Movement Type:** Hover  
**Power Plant:** Nissan 95  
**Cruising Speed:** 129 kph  
**Flank Speed:** 194 kph  
**Armor:** Yelm 2.5 Ferro-Fibrous  
**Armament:**  
1 Aberdovey Mk II Medium Laser  
1 Exostar-2C Small Laser  
**Manufacturer:** Kressly WarWorks  
**Primary Factory:** Eridani Epsilon  
**Communications System:** Essex 88  
**Targeting and Tracking System:** BlazeFire  
SightLock with Beagle Active Probe

## Overview

Once the standard reconnaissance hovercraft of the Star League Defense Force Tank Corps, the Beagle was designed to narrow the sensor advantage BattleMechs enjoyed with the development of the Beagle Active Probe. The Beagle was assigned to almost every tank and hover company in the SLDF, with its mission to provide said company with information and reconnaissance data as it approaches an anticipated battle.

## Capabilities

Designed to rely more on speed than combat ability, the Nissan 95 Fusion Engine provides the Beagle with enough speed to zip in and out of a combat area. Its turret-mounted Beagle Active Probe gives the ho-

vertank such an advanced detection capability, it can identify even powered-down BattleMechs and vehicles lying in wait for a target.

For times when it cannot avoid enemy fire, the Beagle is equipped with three and a half tons of ferro-fibrous armor. For point defense, a front-mounted small laser and a turret-mounted medium laser slaved to the active probe were installed more for the pilot's peace of mind rather than combat effectiveness.

## Deployment

Many of the newly produced Beagles are going to C<sup>3</sup>i networks needing a spotter to swiftly close and get readings for the long-range brawlers. Casualties run high in rough terrain, but the low cost and ease of construction has the Beagle and the new C<sup>3</sup>i variant being churned out in record rates for units in need.

On New Avalon, the fighting reportedly going on has reached a stalemate between the Word of Blake and the besieged Davion forces as of the writing of this entry. Casualties are running high on both sides, and the Jihadists have been relying more on tactical support, mainly from their *Ostscouts* and Beagles. Where the rubble of the planet does not clog the streets and fields, teams of Beagle-TAGs roam, and FedSun defenders have learned to stay far away from them.

## Variants

In an effort to keep Beagle crews from thinking they are a combat unit, Word of Blake began modifying their scout tanks when they were able to begin production of the heavy ferro-fibrous composites in late 3069. This version strips out all the weapons and the active probe in exchange for an improved C<sup>3</sup>i module and a turret-mounted anti-missile system. In addition to the extra protection of the heavier composites, an extra-light fusion engine is mounted, increasing the Beagle's speed to an astonishing maximum of 226 kph. Without any offensive weapons, the drivers are now forced to remember their role as reconnaissance and spotting, not skirmishing.

Another version is produced side-by-side with the Beagle C<sup>3</sup>i. A dual spotter for non-C<sup>3</sup>i units, the Beagle-

TAG variant moves at the same speed as the C<sup>3</sup>i model but carries an active probe and targeting acquisition gear for detection, ambushing and calling in quick fire support. In situations where it needs to lay low, a Guardian ECM keeps it off the radar. This version has been known to be spotted in pairs, roaming the battlefield looking for formations to call in indirect LRM fire or orbital support from a WarShip or aerospace flight.

## Notable Crews

**Sergeant Jasper "Deuce" Perez:** Losing his crew and his Pegasus Scout Tank "Domino" during the fighting on New Avalon in 3070, Perez fell in with an unarmored infantry platoon until they captured a Beagle-TAG during a hasty planned ambush. Commandeering the vehicle for himself, he quickly renamed it "Domino Jr." Sensing an opportunity, he received a fresh coat of Blakist white and up-to date command and IFF codes by MIIO to recon safely behind Blakist lines. During one such patrol, he came across a Level II of assault BattleMechs approaching the FedSun's lines. Thinking quickly, the sergeant keyed in using the captured frequencies and advanced electronics of his Beagle to call in the orbiting WarShip, and using what intel he had gathered, he was able to convince the WarShip crew that the force was an MIIO team fronting as a Blakist unit, and used his target designator to obliterate the Level II with the Blakists' own WarShip. Now painted in Davion Guards colors, Sergeant Perez and "Domino Jr." are wanted by the Word of Blake with a sizeable bounty on his head.



Type: **Beagle**  
 Technology Base: Inner Sphere  
 Movement Type: Hover  
 Tonnage: 15  
 Battle Value: 335

<b>Equipment</b>		<b>Mass</b>
Internal Structure:		1.5
Engine:	95	4.5
Type:	Fusion	
Cruising MP:	12	
Flank MP:	18	
Heat Sinks:	10	0
Control Equipment:		1
Lift Equipment:		1.5
Turret:		.5
Armor Factor:	53	3
	<i>Armor Value</i>	
Front	13	
R/L Side	10/10	
Rear	8	
Turret	12	

<b>Weapons and Ammo</b>	<b>Location</b>	<b>Tonnage</b>
Beagle Active Probe	Turret	1.5
Medium Laser	Turret	1
Small Laser	Front	.5

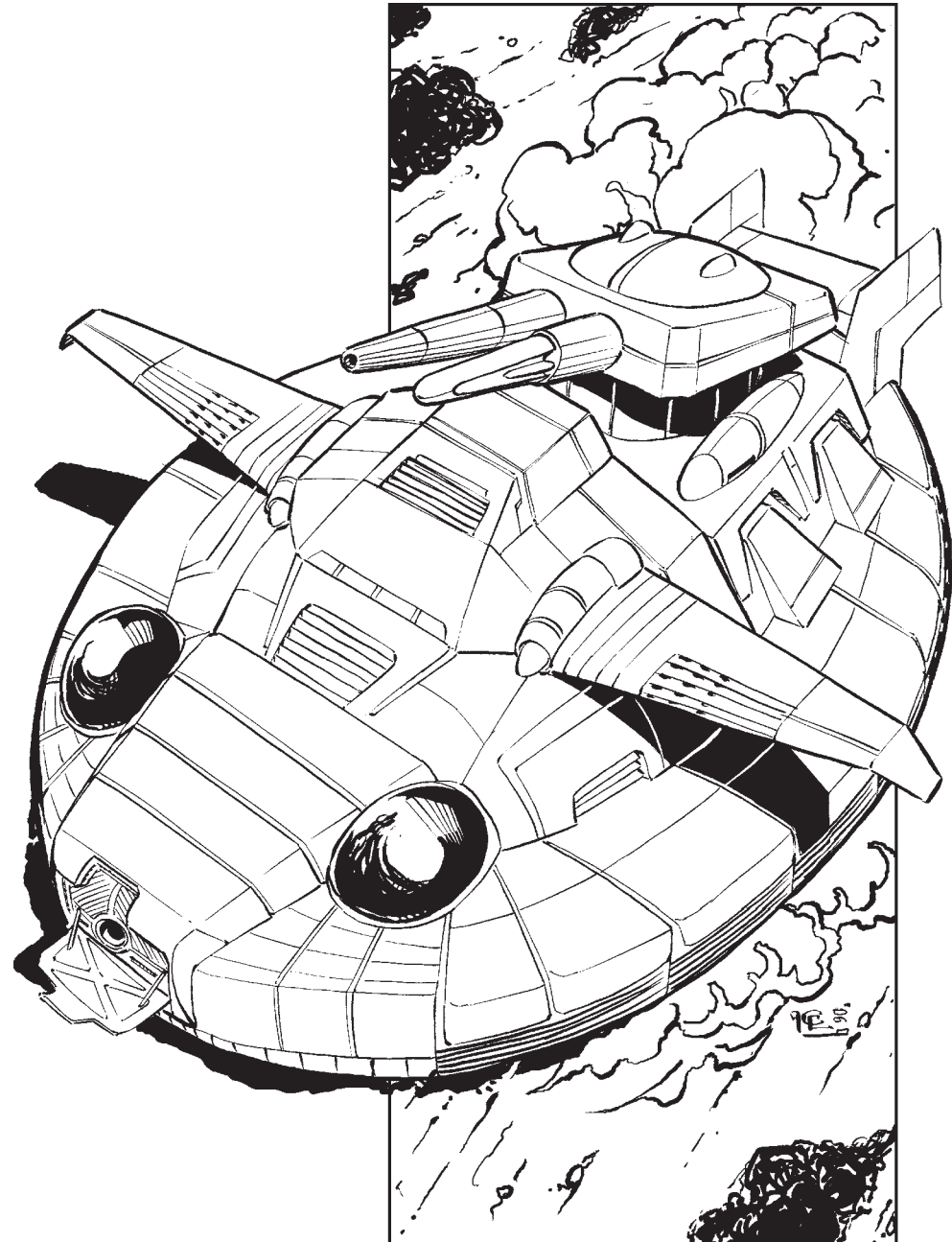

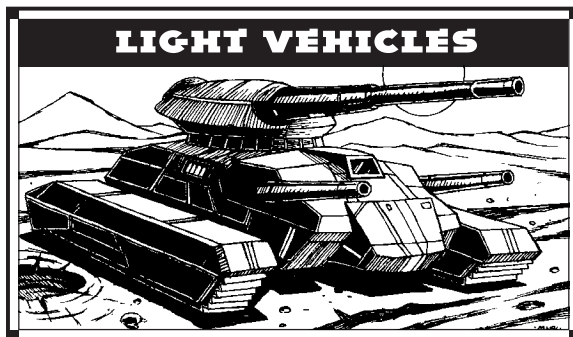

**Mass:** 20 tons  
**Movement Type:** Wheeled  
**Power Plant:** LTV 160  
**Cruising Speed:** 97 kph  
**Flank Speed:** 146 kph  
**Armor:** Mercury Weave Ferro-Fibrous  
**Armament:**  
     1 Holly SRM-2 launcher  
     1 Amdecker 300 Large Laser  
**Manufacturer:** Buhallin Military Products  
**Primary Factory:** Dieron (destroyed 2776)  
**Communications System:** SP/2 HAYOT  
**Targeting and Tracking System:** Hanover Sight  
     3000-A-K-P

## Overview

From a distance the Rotunda looks like any one of a dozen ground car designs, a deliberate choice by its builders, Buhallin Military Products. Ostensibly a scout vehicle, it was intended for use in enemy rear areas where a traditional military vehicle would stand out, monitoring communications and observing troop movements.

## Capabilities

Officially designated the RND-J-1-11 the Rotunda is essentially a self-sufficient home and fighting vehicle for its one-person crew. It can operate for extended periods of time with little maintenance or other support, exploiting a compact fusion plant to have an effectively limitless range. Only the need to supply the

lone driver/gunner with food and consumables keeps the vehicle linked to a base of operations, though three weeks or a month between re-supplies is not uncommon. The Rotunda contains space for cooking and sleeping—the driver and passenger seats fold down to form a rather lumpy mattress, though most drivers prefer to set up a tent outside the vehicle. In most deployments, the Rotunda’s passenger space is not used, instead being employed to store extra consumables or personal effects. When fully loaded, access to the Rotunda’s driver’s seat is cramped and does not allow for fast entry or egress.

Notionally a non-combatant, the Rotunda is nonetheless armed so that it can both defend itself and serve as a light raider. The main weapon is an Amdecker 300 large laser, but a Holly SRM-2 missile pack provides a more heat-efficient weapon system; some drivers are wary of using the Amdecker because of heat buildup in the cramped vehicle. Fighting is, however, a last resort for the Rotunda as it has only a single ton of armor (albeit the advanced ferro-fibrous composite) to protect the driver and systems from harm. This armor plating is intended to protect against crashes and small arms fire rather than vehicular combat in which the Rotunda would likely be trounced.

## Deployment

Entering service in 2717 (though not in widespread use until the mid 2720s), the Rotunda was intended to operate on Periphery worlds as the eyes and ears of the SLDF. It soon became clear, however, that the design could support any SLDF formation, and examples were stationed across the Inner Sphere, often landed in advance of military operations to gather information on enemy deployments and to eavesdrop on communications.

Unfortunately, the scarcity of fusion power plants drove the Rotunda to near-extinction during the Succession Wars, its LTV 160 plant being cannibalized for use in 'Mechs and other military vehicles. The handful still employed by ComStar and the World of Blake largely replicate the original Buhallin spec, though many components have been replaced with Terran equivalents since the loss of the Dieron plant.

## Variants

The J-1-11 was the third model of Rotunda, and the first to see widespread deployment. Its predecessors both suffered technical difficulties: a poor suspension and high maintenance requirement on the original J-100 and a series of electrical issues on the J-110 that otherwise resembled the final production model.

There are no known operational variants of the Rotunda, as all use the same systems and weaponry, though there have been numerous body kits designed to alter the shape and appearance of the vehicle to fool observers. As a result, while most Rotundas resemble compact saloon cars, some resemble SUVs, sports vehicles, or even camper-vans.

## Notable Crews

**“Wild” William Jacobsen:** When the Amaris Coup washed over the Star League, William Jacobsen and his Rotunda were stationed on New Earth, preparing to head out to the Periphery. Slipping out of the military compound, Jacobsen lost himself in the planet’s cities and began what was later acknowledged as the longest single deployment of the Rotunda: eight years, from the coup on Christmas Day 2766 to New Earth’s liberation in 2775. During that time Jacobsen waged a one-man war against Amaris, gathering information on the Rim Worlds troops in the system and staging harassing attacks. Some times he operated with local resistance forces, at others as a free agent. He had no base of operations—the Rotunda was his home and command center—and he relied on the good will of the other fighters for supplies and maintenance. When the SLDF finally liberated New Earth, Jacobsen received the Medal of Valor from General Kerensky. Though long retired when Kerensky’s call went out in 2780, Jacobsen followed his former commander into exile and went on to play a role in the Pentagon Civil Wars and the founding of the Clans.

Type: **Rotunda**  
 Technology Base: Inner Sphere  
 Movement Type: Wheeled  
 Tonnage: 20  
 Battle Value: 400

**Equipment**

		<b>Mass</b>
Internal Structure:		2
Engine:	160	9
Type:	Fusion	
Cruising MP:	9	
Flank MP:	14	
Heat Sinks:	10	0
Control Equipment:		1
Lift Equipment:		0
Power Amplifier:		0
Turret:		0
Armor Factor:	17	1
	<i>Armor Value</i>	
Front	6	
R/L Side	4/4	
Rear	3	

<b>Weapons and Ammo</b>	<b>Location</b>	<b>Tonnage</b>
Large Laser	Front	5
SRM 2	Front	1
Ammo (SRM) 50	Body	1

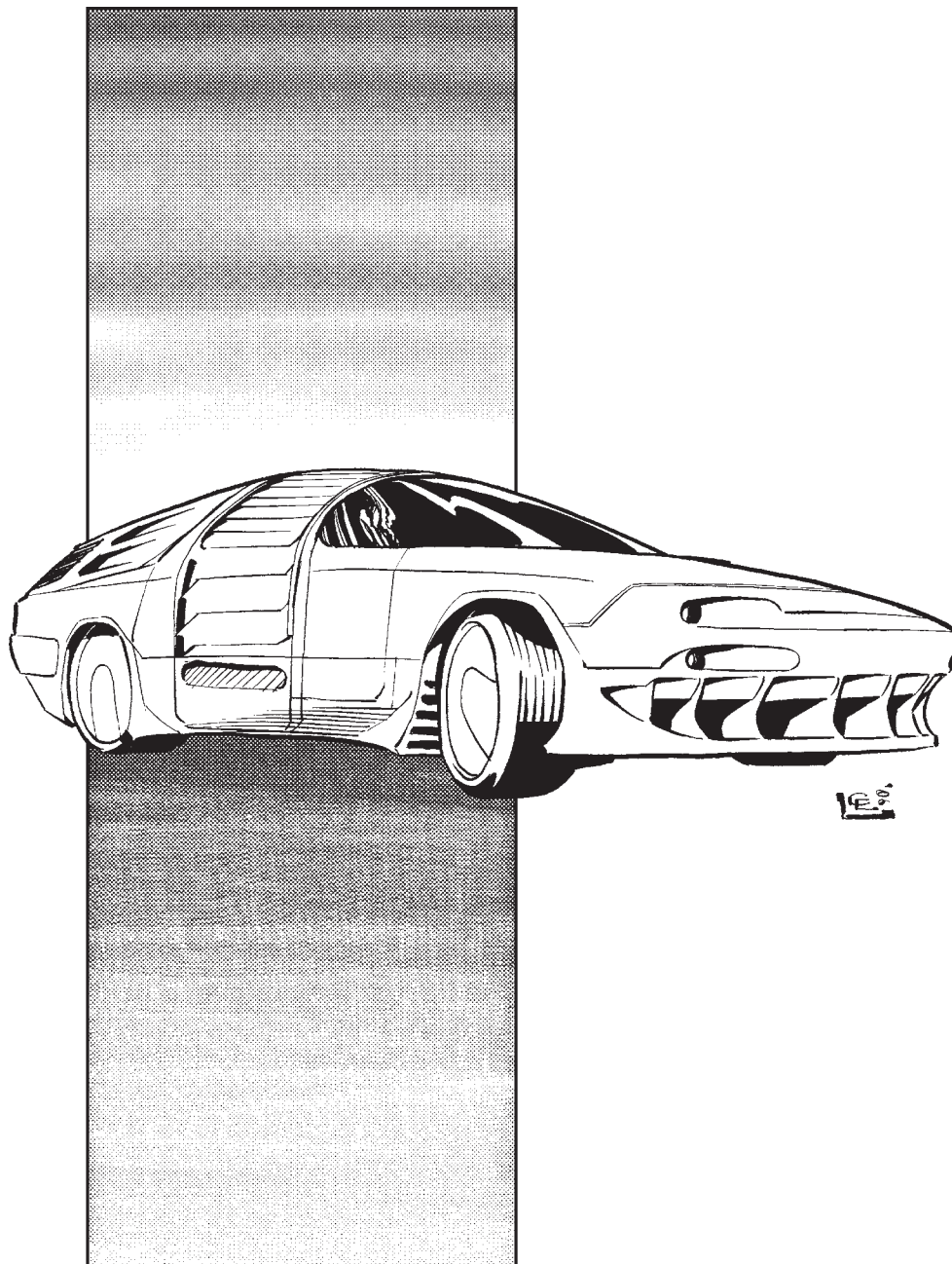

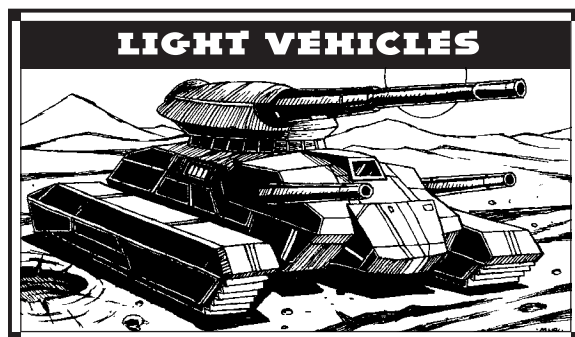

**Mass:** 25 tons

**Movement Type:** VTOL

**Power Plant:** Vlar 160

**Cruising Speed:** 129 kph

**Flank Speed:** 194 kph

**Armor:** FiberTech Light Plus

**Armament:**

1 Moscovia Light Particle Projector Cannon

**Manufacturer:** Meers-Skobel Defense Corporation

**Primary Factory:** Terra

**Communications System:** Johnston VRR 2.0

**Targeting and Tracking System:** Lamprey VXX

## Overview

Known mainly as the first craft to ever carry the Guardian ECM system into combat, the Nightshade knows no other renown. In fact, the Star League designed VTOL is better known in modern combat manuals as “a flying deathtrap with a geeky computer toy.” Only in recent decades, with the re-advent of electronic warfare and the newer C<sup>3</sup> systems, has the idea of a maneuverable electronic countermeasure resurfaced.

Originally designed and produced by Yelm Weapons on New Earth, the last Nightshade entered service with the Star League shortly before General Kerensky’s Exodus. After Yelm’s primary factory was destroyed by a Lyran Commonwealth orbital attack, parts for the vulnerable VTOL became scarce, and by the 2800s, any remaining Nightshades in service were relegated to dusty warehouses and backwater militias, their advanced ECM systems long since cannibalized or destroyed.

In 3063, Dame Yelena Torowicz founded Meers-Skobel Defense Corporation (MSDC). Contracted by the Word of Blake, MSDC was tasked with researching several archived Star League designs and exploring any possible technological advancements that were hinted at or could be replicated in the files. Fascinated with the original mission role of the Nightshade, MSDC found a way to incorporate the proven C<sup>3</sup>i technology and breathe new life into the VTOL as a fast and maneuverable spotting vehicle.

Since its initial unveiling in 3069, the Nightshade has become a common sight among Word of Blake forces, primarily found in their Protectorate Militia divisions.

## Capabilities

Retaining the original design’s high top speed and sophisticated Guardian ECM, the new and improved Nightshade incorporates the lighter ferro-fibrous armor plating, giving the VTOL almost 35 percent more coverage. The redistribution of weight allows the Nightshade to retain its respectable speed as well as mount one of the Word’s new light particle cannons. Coupled with the Word’s C<sup>3</sup>i systems, this new Nightshade has become a deadly sniper as well as an advanced scouting platform for heavier units.

## Deployment

The original Nightshade is a rare sight on today’s battlefield—usually it is a custom refit, as parts for the older Yelm Weapons version are exceedingly hard to come by. The largest number of these light VTOLs were originally stationed as trainer vehicles on Tukayyid, and none are known to have survived the Word’s two-year bombardment of that system.

The newer MSDC version is exclusive to the Word of Blake, though there are some scattered reports of a few mercenary commands fielding them after run-ins with Protectorate forces.

## Variants

Yelm Weapons’ Nightshade originally mounted a standard Randall Medium Laser along with a NIRAD 210 Guardian ECM suite. The light armor load made the design very susceptible to sustained ground fire,

which made the VTOL highly unpopular with its pilots. During the Succession Wars, when the Guardian system was destroyed beyond repair, several savvy crews yanked the system and ancillary components out, creating a small and very cramped passenger area for two people.

Less-than-reliable reports from the embattled Confederation have reported a newer Nightshade variant seen on several Protectorate border worlds. These craft mount a light autocannon system paired with target acquisition gear and are usually found attached to artillery units. The Confederation has reported some success in destroying these new variants, but as always, one must question the veracity of such boastful reports from the Capellans.

## Notable Crews

“**Vashti**”: More a noted VTOL than the crew that pilots it—rumor has it there are actually three separate crews for this posh classic—the Vashti is the personal ride of Precentor Garin Latronis on Sheratan. Known mainly for his underhanded dealings among several mercenary forces, his duplicity helped not only to move Sheratan into the Protectorate but also managed to destroy the Grim Determination. Supposedly unarmed, this Nightshade is one of the few Yelm Weapons designs still functioning. Sporting additional armor at the expense of speed, the Vashti has been seen surviving several laser barrages from rebel forces still operating on Sheratan. If the small rebellion on the planet hopes to succeed, they apparently will need larger firepower to bring this Blakist egomaniac low.

**Adept Torson Gnowles:** Little is known about Adept Gnowles after his “accident” at the hands of ComStar ROM agents on New Home in 3063. Originally presumed dead from grievous injuries, this Word of Blake Adept was identified during a recent intelligence mission to Thorin as a member of the Thirty-ninth Division. Once known as a superior VTOL pilot before the explosion, Gnowles has been positively identified as a Manei Domini Omega operating as a personal guard for the unit’s Precentor.

Type: **Nightshade**

Technology Base: Inner Sphere

Movement Type: VTOL

Tonnage: 25

Battle Value: 471

### Equipment

		<b>Mass</b>
Internal Structure:		2.5
Engine:	160	9
Type:	Fusion	
Cruising MP:	12	
Flank MP:	18	
Heat Sinks:	10	0
Control Equipment:		1.5
Lift Equipment		2.5
Armor Factor:	42	2.5
	<i>Armor</i>	
	<i>Value</i>	
Front	13	
R/L Side	10/10	
Rear	7	
Rotor	2	

### Weapons and Ammo

	<b>Location</b>	<b>Tonnage</b>
Light PPC	Front	3
Guardian ECM	Body	1.5
C <sup>3</sup> i Computer	Body	2.5

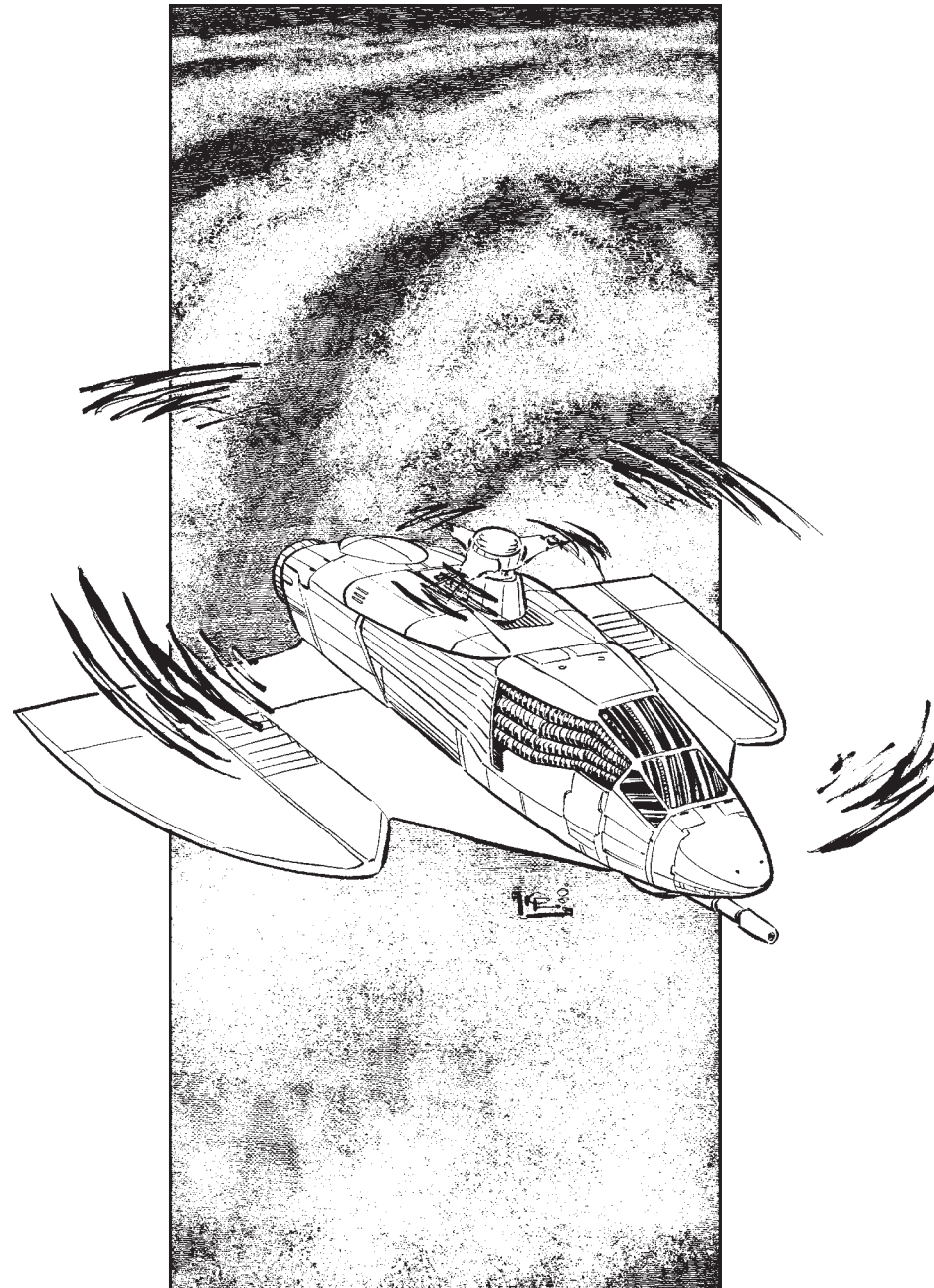

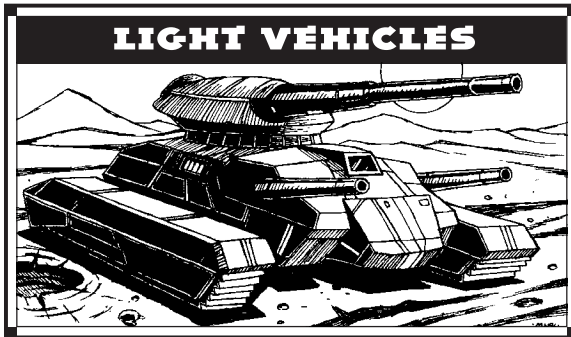

**Mass:** 30 tons

**Movement Type:** VTOL

**Power Plant:** DAV 220

**Cruising Speed:** 130 kph

**Flank Speed:** 194 kph

**Armor:** Paulina DL Ferro-Fibrous

**Armament:**

1 Fuersturm-C Large Laser

**Manufacturer:** Paulina Weapons

**Primary Factory:** New Vandenberg

**Communications System:** Garret M250

**Targeting and Tracking System:** Sky Tracer WL  
with Beagle Active Probe

## Overview

After the Reunification War, the Star League prompted several corporations to explore opportunities within the subjugated Periphery realms. Paulina Weapons—originally based on Tigress—took advantage of the Star League’s offer and built an impressive facility outside the planet’s capital. Employing over two thousand people, the small-weapons manufacturer managed to jumpstart New Vandenberg’s war-torn economy within two years. The company’s primary success was the development of the Cyrano gunship in 2622, with the SLDF so enamored with the design that they became the primary purchaser of the light gunship.

Until recently, it was believed that the New Vandenberg facility was destroyed by a FedSuns-financed pirate force that swept through the system in 2840. However, recent evidence brought to the Taurian gov-

ernment by the Word of Blake has shown this was actually a strike brought about by ComStar during Operation Holy Shroud. Though many critics decry the evidence as a manipulative ploy to butter up the current administration (many consider the Word to be a continuation of the old ComStar and not some new organization), no one can deny that the Word’s offer to rebuild the facility at no cost to the Taurian people has done much to stem anti-Word rhetoric.

The Word of Blake did indeed rebuild the facility, and the first of a new breed of Cyranos began lifting from the assembly line in late 3071. Though currently staffed by Blakist workers, it is expected the Concordat will take ownership of the factory in the late 3080s.

## Capabilities

Woefully under-armored with a thin ferro-fibrous shell, the Cyrano was originally used as an escort gunship for more heavily armed Nightshade and Ripper strike forces. Because of the advanced targeting suite used in conjunction with the Fuersturm laser, it also became a popular training craft—the Beagle probe had the capability of replaying the last thirty minutes of footage while also continuing to record. This capability was invaluable to the side-seated Fire Information Officer, who utilized it for detailed examinations of the battlefield for critical intelligence. The Cyrano could stay aloft for hours at a time with little need for resupply. The cockpit is designed for such long flights, with self-conforming pilot seats to allow for maximum comfort and functionality.

## Deployment

During the Golden Age of the Star League, almost every army and division maintained at least three squadrons of Cyranos to be used for training, scout, and escort duty. Its low maintenance schedule made it a mechanic’s dream, even though pilots loathed the pitiful amount of armor.

## Variants

The Word redesigned the Cyrano for the TDF, utilizing light engine technology gained from the Out-

worlds Alliance. The lighter engine allowed the craft to retain its incredible speed and mount an additional two tons of armor. Eschewing the original large laser mount, these newer Cyranos now mount one of the Concordat’s newer plasma rifles (technology traded to the Concordat to help fight the Davion threat). For the open market, Paulina has also developed a lesser version of the VTOL, retaining the original fusion engine, adding half a ton of armor, replacing the Fuersturm laser with two Exostar mediums, and piling on as many rocket launcher pods as possible to make a very potent scout escort.

## Notable Crews

**Force Sergeants Alex “Baka” Dziski and John “Twofer” Quintus:** Permanently assigned to the Red Gate Infantry of I Corps, these two Vandenberg natives have managed over fourteen VTOL kills during several low-level conflicts with the Magistracy in the Fronc Reaches. Having discovered the tactical strength of the new plasma rifle system, a favored tactic is to force a target to drop to nape-of-earth piloting. With pinpoint targeting, Dziski then pegs the fleeing craft with a plasma shot, overheating the vessel, which crashes from the loss of control. The Word of Blake has expressed interest in having the two train several Blakist pilots in the tactic, which the I Corps has so far rebuffed.

**Corporal Billy “Danger” Maus and Private Ted “Upper” Hughes:** Attached to the SLDFs Fifth Army when General Kerensky issued his Exodus call, both men refused to follow and remained behind. Convincing the rest of their squadron to remain as well, they instead returned to the Concordat and signed on as a mercenary unit. The squadron performed admirably for years, falling only in the inspired but futile defense of the Paulina Weapons complex. In honor of their selfless defense, the government of New Vandenberg named a park after them; Maus and Hughes’ own Cyrano is preserved there as a memorial to the unit’s fighting spirit.

Type: **Cyrano**  
 Technology Base: Inner Sphere  
 Movement Type: VTOL  
 Tonnage: 30  
 Battle Value: 454

<b>Equipment</b>		<b>Mass</b>
Internal Structure:		3
Engine:	220	15
Type:	Fusion	
Cruising MP:	12	
Flank MP:	18	
Heat Sinks:	10	0
Control Equipment:		1.5
Rotor Equipment:		3
Power Amplifier:		0
Armor Factor:	17	1
	<i>Armor Value</i>	
Front	5	
R/L Side	4/4	
Rear	2	
Rotor	2	

<b>Weapons and Ammo</b>	<b>Location</b>	<b>Tonnage</b>
Large Laser	Front	5
Beagle Probe	Front	1.5

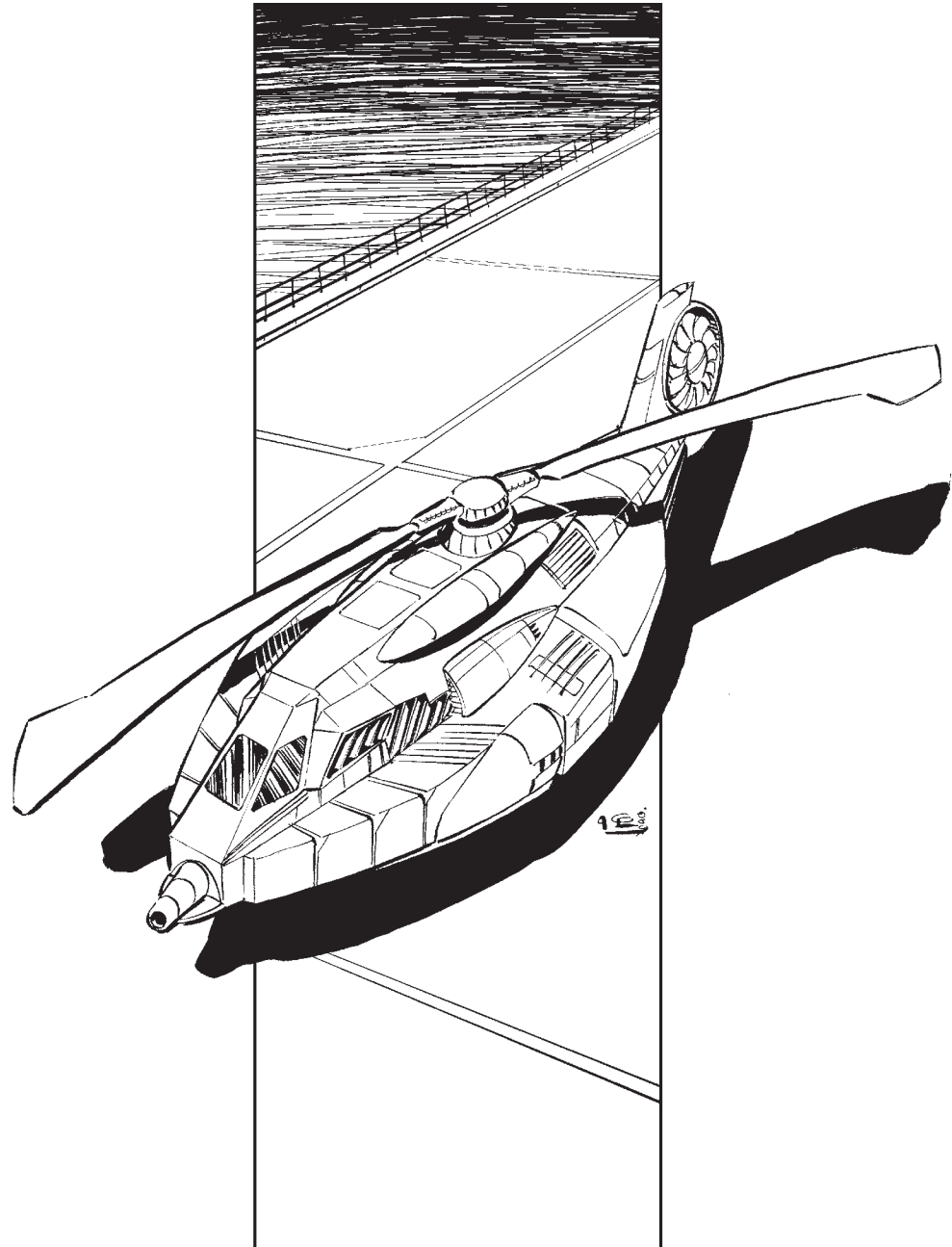

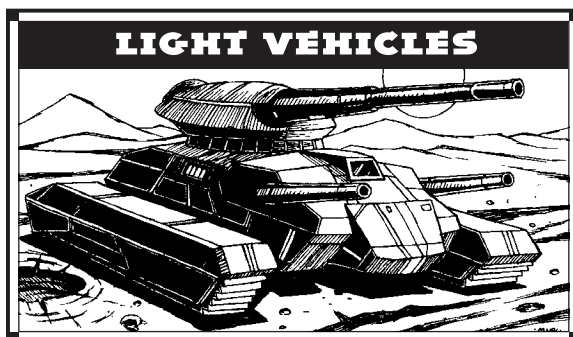

**Mass:** 35 tons

**Movement Type:** Hover

**Power Plant:** GM 210

**Cruising Speed:** 119 kph

**Flank Speed:** 184 kph

**Armor:** StarSlab/3 Ferro Fibrous

**Armament:**

2 Raker-IV Medium Pulse Lasers

2 Maxima One Shot SRM-4 Missile Racks

**Manufacturer:** Kressly Warworks

**Primary Factory:** Epsilon Eridani

**Communications System:** Century Model 770

**Targeting and Tracking System:** TGI 2331C/  
TGI F-190

## Overview

Wanting to gain an advantage over enemy formations, the Star League Defense Force commissioned Curtiss Industries to design and produce a light, fast vehicle that could break up enemy formations before the main battle was joined or at a key moment during a pitched battle when a quick but powerful strike is needed. In 2696, the Lightning was unveiled and, with its advanced fire-control system and high speed, was quickly distributed throughout the SLDF.

## Capabilities

Fast and nimble with a top speed of over 180 kilometers per hour, the Lightning can easily insert itself into any combat situation and extract itself afterwards. The designers had spared no expense in making

the strike tank as maneuverable as possible, as they mounted small thrusters in addition to rear wings with elevators to allow crews a high amount of control when moving at top speeds. A fringe benefit of this superior maneuverability is that it enables the Lightning to jump over low obstacles; testing has proven the craft can clear obstacles up to two meters high. This is a very difficult maneuver in practice, however, even for expert crews. As it can only be attempted with the craft going flat-out, numerous Lightnings have been destroyed and their crews killed during failed attempts.

For combat, the Lightning is primarily armed with a One-Shot SRM-4 on each flank of the vehicle's hull. Designed so the Lightning could fire off a launcher at a BattleMech's side on a pass, and on the pass back, fire off the other launcher at the same target side as necessary, in small groups, a volley can be quite damaging to a BattleMech. As it approaches head-on, a pair of medium pulse lasers only adds to the short-range punch of the thirty-five-ton hover tank.

## Deployment

Kressly began mass production of the Lightning in August 3067, mere months before dissolution of the Second Star League. Though many were observed being produced, very few could be traced to their final destination.

On Tikonov, the heavy presence of Shadow Lances fighting an intense hit-and-run campaign kept the Blakist invasion force from claiming complete control over the massive factory complex. The stealth-equipped BattleMechs would appear out of nowhere, striking hard before fading back behind what remained of the Confederation's lines. Needing a force capable of swiftly reacting with overwhelming firepower to disable the Shadow Lances before they could retreat, one of the Blakist Precentors equipped several Level IIs with the new Lightning-RL craft. He carefully sent them out several kilometers away to wait for a call to action.

When a pair of Shadow Lances attempted to raid the facility yet again, the Precentor called the strike teams to make their move. The craft sped into the enemies' rear, targeting a pair of *Pillagers* and a

*Warhammer*. Their barrage of missiles crippled a *Pillager* and destroyed the other two BattleMechs. With the bulk of the firepower taken out of the fight so early on, the remaining machines lingered just long enough to recover their fallen pilots and withdrew from the fight. Just as they made it back to friendly territory, the Lightning-RLs reappeared to make another pass as they were able to reload their pods in record time. The lighter-armored BattleMechs stood no chance, and on the second pass the rest of the Shadow Lances fell to the missile barrage.

## Variants

When Word of Blake resumed production of the Lightning, they redesigned the strike tank to take advantage of the cheap, low-tech but potent rocket pods in an effort to negate some of the advantages possessed by the Allied Mercenary Command. The Lightning-RL exchanges the twin pulse lasers for a pair of anti-missile systems and mounts seven rocket pod-15 racks directed toward the front. Small cost-effective headhunter units have been used to great effect in swiftly approaching and disabling key enemy units, such as C<sup>3</sup> master nodes and House Liao's feared Shadow Lances, negating the enemy's few advantages.

Other variants exchange the anti-missile systems for various types of ER lasers in an effort to improve the craft's battlefield endurance.

## Notable Crews

**Precentor Robert Havasy:** Now in charge of the defense of the Tikonov factories, Havasy's concept and execution of rocket-pod equipped hovercraft swiftly closing and disabling insurgents before they can retreat has been adopted by many other Protectorate garrisons. Many worlds still needing pacification now keep a Level II or more of these craft on hand should the need arise.



Type: **Lightning**

Technology Base: Inner Sphere

Movement Type: Hover

Tonnage: 35

Battle Value: 510

**Equipment**

		<b>Mass</b>
Internal Structure:		3.5
Engine:	210	13.5
Type:	Fusion	
Cruising MP:	11	
Flank MP:	17	
Heat Sinks:	10	0
Control Equipment:		2
Lift Equipment:		3.5
Power Amplifier:		0
Turret:		0
Armor Factor:	62	3.5
	<i>Armor Value</i>	
Front	20	
R/L Side	16/16	
Rear	10	

<b>Weapons and Ammo</b>	<b>Location</b>	<b>Tonnage</b>
Medium Pulse Laser	Front	2
Medium Pulse Laser	Front	2
SRM 4 (OS)	Left	2.5
SRM 4 (OS)	Right	2.5

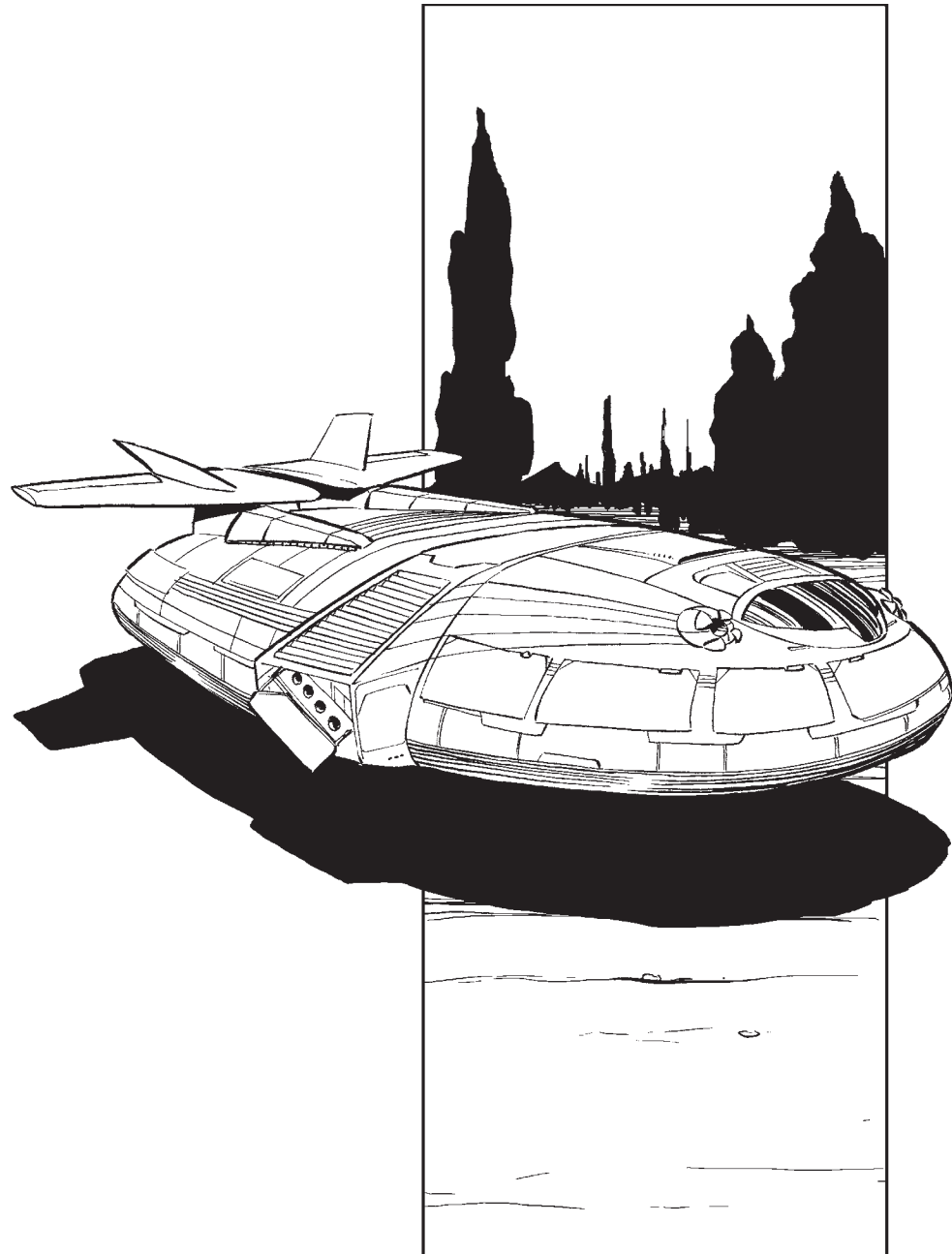

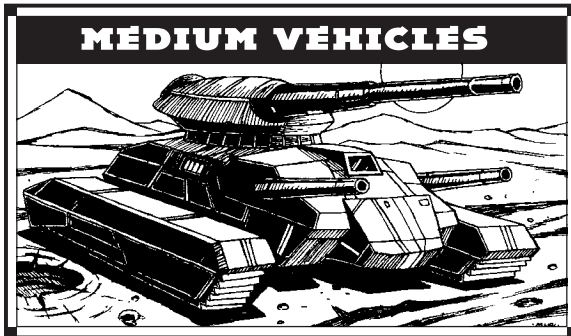

**Mass:** 40 tons

**Movement Type:** Hover

**Power Plant:** GM 185

**Cruising Speed:** 97 kph

**Flank Speed:** 151 kph

**Armor:** Grumman CRT Ferro-Fibrous

**Armament:**

3 Bowie Electronics Medium Lasers

1 Thor SRM-6

1 Bowie Electronics Small Laser

**Manufacturer:** Grumman Industries

**Primary Factory:** Terra

**Communications System:** Guardian ECM Suite  
Systems X

**Targeting and Tracking System:** Bundesweyth  
Target Acquisition Gear

## Overview

Though the Zephyr was generally used as a companion hover tank to support infantry and fast-response units after its introduction in 2620, the SLDF instead utilized the vehicle as a support tank for its Chaparrals. Because the Guardian ECM system was judged a battlefield success, the SLDF insisted Grumman industries install the new equipment on all subsequent Zephyr orders.

When the Word of Blake replaced ComStar as the ruling power on Terra, Grumman executives were given a large infusion of capital to invest in upgrading and expanding their vehicle production lines. One of the first orders of business for the ancient manufacturer was to revamp the proven Zephyr design to incorporate the improved C<sup>3</sup> computer system. When unveiled to the

Precentor of Terran Security, the company received a huge contract to proceed with production at the Terran plant. Orders from the office of TerraSec were so high that Grumman opened a new manufacturing plant on New Earth in 3066 to keep up with demand tied to the formation and expansion of several Word of Blake Militia and Protectorate forces.

In 3071, dissidents within the Grumman-New Earth branch began harboring doubts regarding the Word's actions outside of the Protectorate. Before their departure for a long "retreat" at Terran headquarters, the New Earth branch managed to smuggle well over two hundred of these tanks to Protectorate enemies. Currently, the entire facility is under lockdown, pending an exhaustive investigation.

## Capabilities

Though the original Zephyr design was capable of its primary mission—an escort tank for field artillery and long-ranged fire support—its above-average speed and armor ratios were deemed as being underutilized. After some reconditioning of the design (mainly to incorporate the WoB's C<sup>3</sup>i technology), two newer variants have emerged that allow both to work within other C<sup>3</sup>i networks. Most common among Protectorate forces, several Level IIs are made up of Zephyrs and armored infantry, creating fast-strike response units capable of exploiting breaches in enemy formations.

## Deployment

Found nearly exclusively among Word of Blake Protectorate and Militia forces, the newer Zephyrs are only seen in other forces that have captured the tanks after pitched battles. Despite the smuggling operations by Grumman executives to Protectorate rebels, such sightings are exceedingly rare.

More common is the older original design, which is seen among ComStar, Combine, and FRR forces. Mercenaries capable of maintaining such a high degree of technology are also apt to field one, due to the heavier armor and quick speed that allows for fast redeployment of ECM assets. This has become especially important in recent years in combating the Word's dangerous and flexible C<sup>3</sup>i networks.

## Variants

The first variant—which has been noted as early as 3062—incorporates both ECM and C<sup>3</sup>i computer systems. To fit the newer technology, the SRM-6 pack in the nose has been downgraded to a Streak-2. These variants are found most commonly in other C<sup>3</sup>i combined-arms Level IIs, often as a flanker or point unit.

Less is known about the second variant rumored to be in use among Protectorate forces. Apparently the C<sup>3</sup>i system is retained but the TAG, ECM, SRM pack and rear laser are removed in favor of two LRM racks mounted in the nose. The resultant look gives the Zephyr a blockier appearance and has been designated the "Pug" by those few mercenary forces who have engaged it. The turret also lacks a third laser mount, which leads many analysts to assume this Zephyr mounts ER lasers. So far, this version has only been spotted on Caph, Epsilon Eridani, and Outreach.

## Notable Crews

**"Arrow":** One of the few recorded Zephyrs known to have survived the Liberation of Terra, this hover tank was originally assigned to the Amaris Dragoons. Salvaged by Kerensky's forces, it actually made the journey with the SLDF on its Exodus from known space. The tank survived the subsequent Pentagon Wars and changed hands through three Clans before being deposited in a Brian Cache on Huntress by the Smoke Jaguars. Claimed as isorla by the Goliath Scorpions, it was bequeathed to a former Eridani Light Horse cavalry team upon their acceptance into the Clan. The three warriors—Janse, Trevor, and Karl—and the "Arrow" were reported MIA during the recent battling on Shadow and are presumed either dead or bonded to the Fire Mandrills.

**Rudolph Brice:** A former Vice President of Grumman-New Earth, Brice narrowly escaped a Word of Blake detainment team when the corporate offices were raided in the early 3070s. One of the key players of the corporation's underground rebellion cells on New Earth, Brice was responsible for redirecting over two hundred of the newly built Zephyrs to smugglers and other black marketers operating between the Protectorate and the Skye region of the Alliance. He is currently wanted by the Word of Blake, which has placed a 75 million C-Bill bounty on his head.

Type: **Zephyr**

Technology Base: Inner Sphere

Movement Type: Hover

Tonnage: 40

Battle Value: 889

**Equipment**

Internal Structure:

Engine: 185  
 Type: Fusion  
 Cruising MP: 9  
 Flank MP: 14

Heat Sinks: 10

Control Equipment:

Lift Equipment:

Turret:

Armor Factor: 125

*Armor*

*Value*

Front 29

R/L Side 24/24

Rear 19

Turret 29

**Mass**

4

11.5

0

2

4

.5

7

**Weapons and Ammo**

3 Medium Lasers

TAG

SRM 6

Ammo (SRM) 30

Small Laser

Guardian ECM Suite

**Location**

Turret

Turret

Front

Body

Rear

Body

**Tonnage**

3

1

3

2

.5

1.5

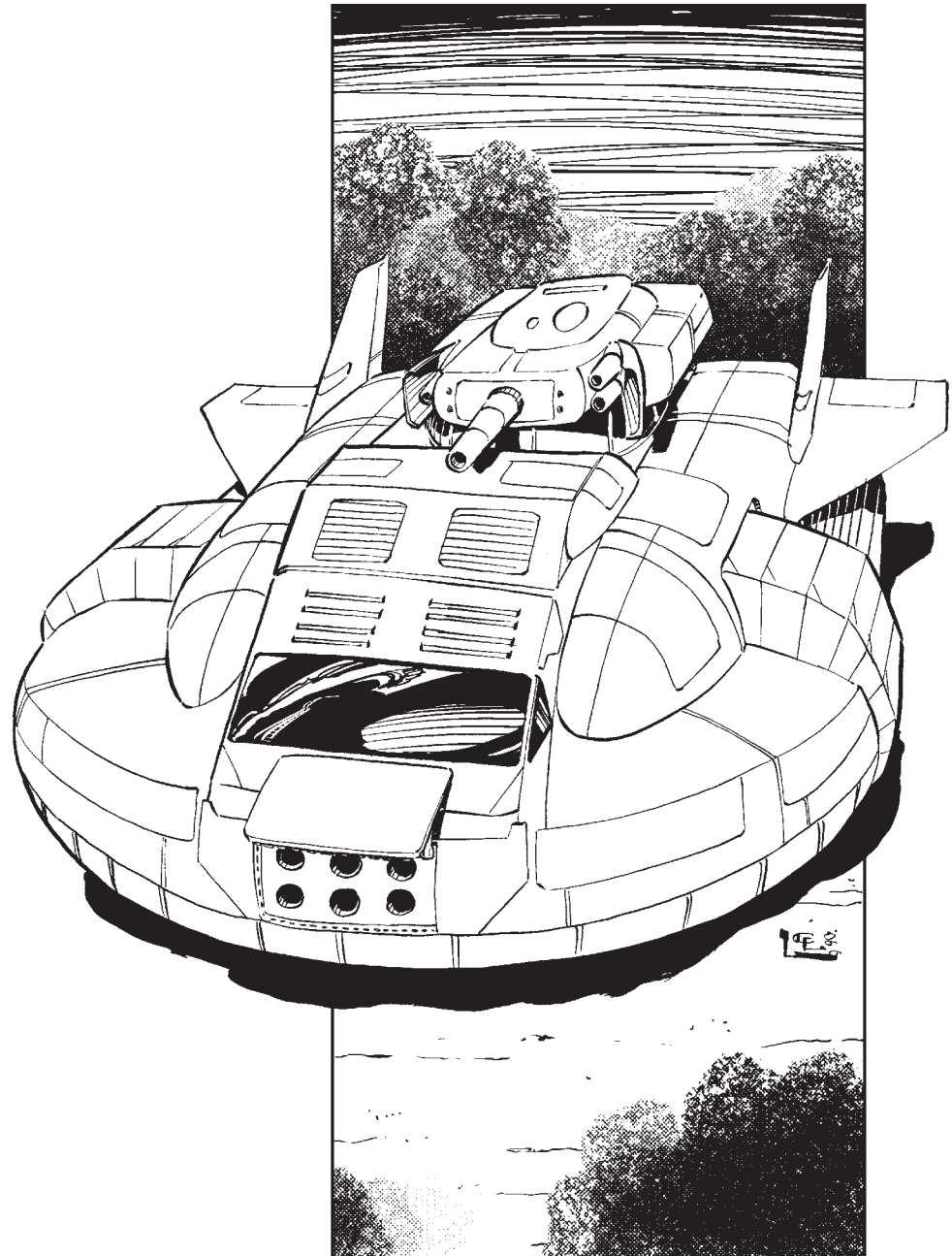

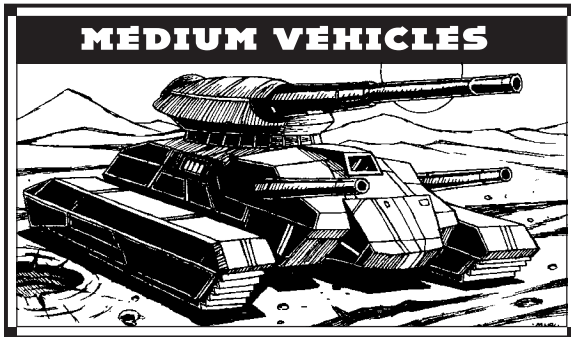

**Mass:** 50 tons

**Movement Type:** Tracked

**Power Plant:** Nissan 200

**Cruising Speed:** 43 kph

**Flank Speed:** 64 kph

**Armor:** StarSlab/1

**Armament:**

2 Sapphire Medium Lasers

1 Shrike SRM-6 Missile Rack

2 AIL Arrow IV Launchers

**Manufacturer:** Grumman Industries

**Primary Factory:** Terra

**Communications System:** TransComm 12

**Targeting and Tracking System:** TransComm  
WDS40A

## Overview

In the early twenty-seventh century, tacticians and strategists were looking for a fast-moving conventional platform that could use the Arrow IV surface-to-surface missile system to provide effective fire support for frontline infantry and light armor. Competition among weapons manufacturers was intense, but the need for both sufficient armor and speed meant compromises—or new thinking—were required. In 2609, Grumman Industries secured the contract with their fifty-ton Chaparral, which mounted the Arrow IV system in an innovative pod assembly. The pod and the relatively vulnerable Arrow IV launcher could be raised above the low-slung hull for a one hundred and eighty degree field of fire. When not firing, the pod retracts

into the hull, giving the well-armored Chaparral a sleek, low—and easily missed—profile one corporate rival compared to a cockroach. The first production run of Chaparrals rolled off the assembly lines in 2611.

## Capabilities

The heart of the Chaparral is of course the Arrow IV launcher. Because the Arrow IV has a much shorter range than the Long Tom, Thumper, or even Sniper, the Chaparral must get much closer to the target area to provide effective support—which is why speed and armor are essential to its survival. Though the Arrow IV can launch a wide variety of munitions, not all are suitable for the Chaparral. Given the tank's lack of CASE—the Chaparral's only serious flaw—it is a rare crew that will carry the notoriously risky Inferno IV rounds. The Chaparral's Arrow IVs usually fire area-saturation missiles that can concentrate devastating explosive power in a precisely defined area. It is also common for Chaparrals to carry homing missiles and work in conjunction with TAG teams.

The Chaparral is not designed to attack a target directly. In fact the designers expected it to respond to direct attacks by fleeing. As a result, all close-range defensive weapons are positioned to cover the fifty-ton tank's sides and rear, while the majority of the tank's armor also covers the rear.

Two Sapphire medium lasers are mounted on either side of the primary hull. Facing directly aft, with enough traverse to cover the flanks as well, is a six-tube Shrike SRM launcher.

## Deployment

The loss of Arrow IVs during the Succession Wars (and ComStar's excessive red tape on any Terran military export) ended the Chaparral's career for two centuries. This changed in 3053 when Focht opened Terra's borders, allowing the Inner Sphere to witness the prodigious production of a modern Terran factory. Despite being once again denied to the Inner Sphere following the Word of Blake conquest of Terra, the Chaparral can be found in all of the major militaries of the Inner Sphere and Periphery, and it is used by many of the larger mercenary commands.

## Variants

The Chaparral is so well respected out of the box that there are few variants in widespread use. The Shrike requires expensive maintenance to keep it in top form, meaning it is not uncommon in under-funded units to replace the SRM-6 launcher with an SRM-4 and devote the additional space to more ammunition or an anti-infantry machine gun. There are also unsubstantiated reports of Chaparrals mounting ER medium lasers in place of the Sapphires.

## Notable Crews

**Beta Platoon, Baker Company:** During the Liao-Marik Offensive of 3057, Little Richard's Panzer Brigade made an unsanctioned probe in force to test the mettle of the Taurian Concordat. Their test subjects were the Concordat Commandos—a choice that made sense on the data screen. The Commandos were a smaller command than Richard's, comprised primarily of lighter BattleMech designs. More to the point, despite their long history, there was little to indicate how well the current generation of Commandos would fare in combat. As it turned out, they fared very well indeed, fighting Richard's Panzers to a standstill. When Major Malcolm Powell dispatched a demicompany of Panzer heavy and assault 'Mechs to outflank the Commandos, Subaltern Laura Ganes, commander of the Commando's Fifteenth Armored Cavalry, ordered Baker Company to hold the unprotected quarter. While Alpha and Gamma platoons—made up primarily of Manticores and Plainsmen—attacked the oncoming Panzer 'Mechs directly, Beta Platoon took position on a low rise to provide fire support. Though they fought tenaciously, the Manticore and Plainsman tanks were simply overmatched by the Panzer assault 'Mechs and suffered fifty percent losses in a dozen minutes. It fell to Baker Platoon and their precisely targeted saturation barrages to stall the Panzer advance until Commando BattleMechs arrived.

Type: **Chaparral**  
 Technology Base: Inner Sphere  
 Movement Type: Tracked  
 Tonnage: 50  
 Battle Value: N/A

**Equipment**

		<b>Mass</b>
Internal Structure:		5
Engine:	200	13
Type:	Fusion	
Cruising MP:	4	
Flank MP:	6	
Heat Sinks:	10	0
Control Equipment:		2.5
Lift Equipment:		0
Power Amplifier:		0
Turret:		0
Armor Factor:	88	5.5
	<i>Armor Value</i>	
Front	16	
R/L Side	18/18	
Rear	36	

<b>Weapons and Ammo</b>	<b>Location</b>	<b>Tonnage</b>
Medium Laser	Right	1
Medium Laser	Left	1
SRM 6	Rear	3
Ammo (SRM) 15	Body	1
Arrow IV System	Front	15
Ammo (Arrow IV) 15	Body	3

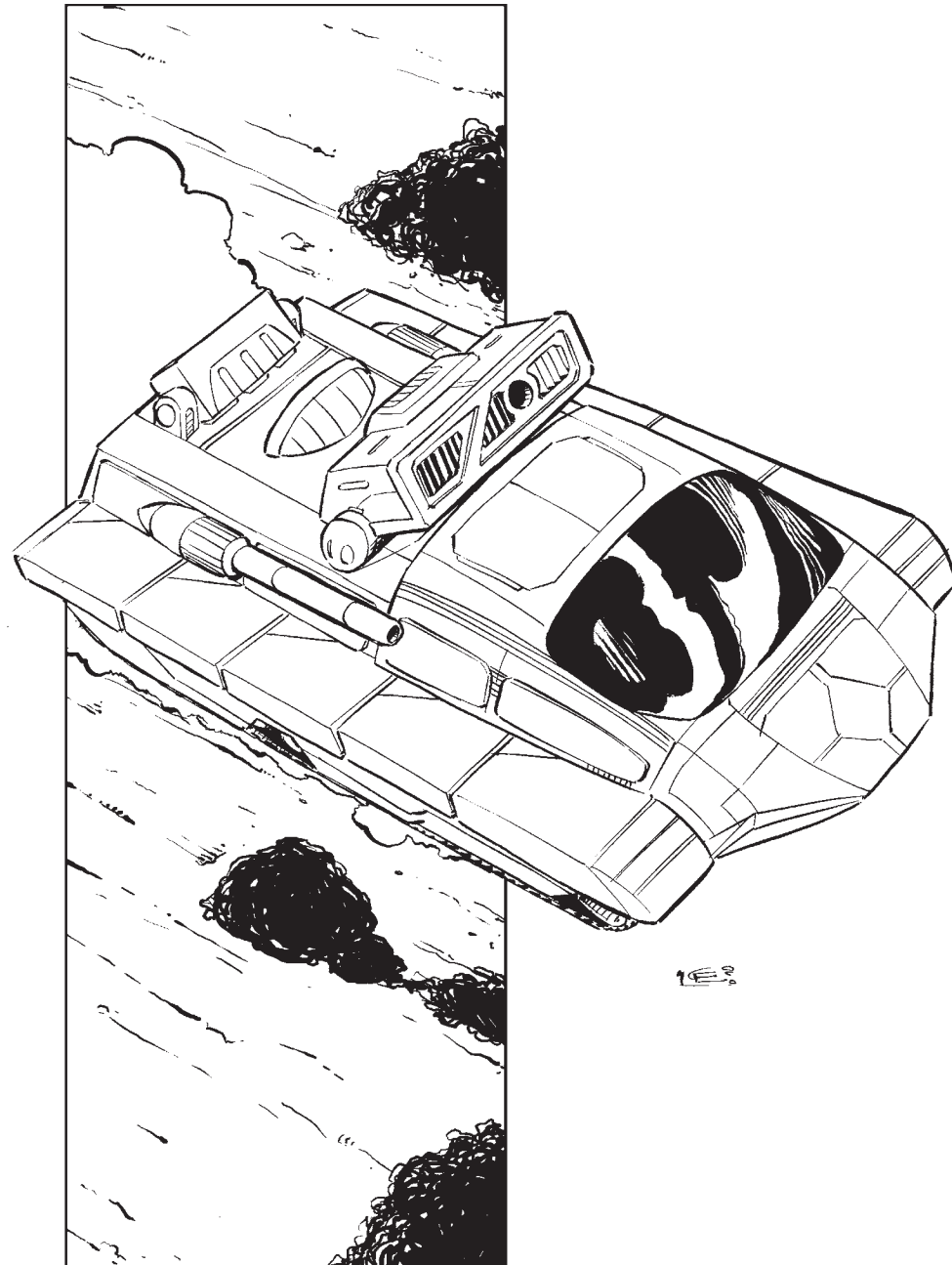

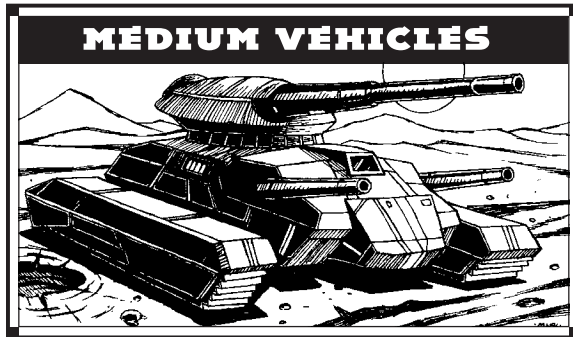

**Mass:** 50 tons

**Movement Type:** Hover

**Power Plant:** Janzen 165 Internal Combustion

**Cruising Speed:** 86 kph

**Flank Speed:** 129 kph

**Jump Jets:** Mitchell JB Thrust Bottles

**Jump Capacity:** 180 meters

**Armor:** Durolex Standard

**Armament:**

- 1 Lonworth Type V Autocannon
- 1 General Datatech Vertical Launch LRM-10 System
- 1 General Datatech Vertical Launch SRM-4 System
- 1 Tri-Axe Machine Gun

**Manufacturer:** Mitchell Vehicles

**Primary Factory:** Graham IV (destroyed 2767)

**Communications System:** Stony AIX

**Targeting and Tracking System:** AL2200 Track-Nav AI System

## Overview

A unique concept devised by SLDF General Alvarez “Buzz” Mitchell in the mid-2650s, the Kanga was a promising answer to the mobility restrictions of modern combat vehicles faced in contrast to those of BattleMechs. The complex and expensive solution, lost to the fires of the Succession Wars, ironically made the Kanga a powerful tool for the SLDF vehicle corps, but eventually led to its demise as a battlefield unit when the sophisticated technology grew scarce.

## Capabilities

Though the theory behind the Kanga was simple—strapping jump jets to the hull of a fast hover tank—the spectacular failure of several prototypes proved that the balance and navigational issues involved were far more complex than first believed. This realization led the engineers at Mitchell Vehicles (a Graham IV-based company chaired by General Mitchell’s cousin, Ramon Mitchell) to turn to the advanced computing technologies of the Nirasaki Computer Collective. Nirasaki’s solution was the advanced AL2200 Track-Nav AI computer, an artificial intelligence system that incorporated inertial guidance and modified gyroscopes with navigational instrumentation and enhanced target-tracking gear.

Far more sophisticated and intuitive than any control or tracking system previously conceived, the AL2200 not only provided superior military sensor capabilities but also helped stabilize the Kanga through jump maneuvers. Designed to work with the driver, the AL2200 could scan, recognize, and adapt to any form of terrain, weather condition, and gravitational circumstances—within certain tolerances. Its ability to completely control the vectored thrust of the Kanga’s six JB Thrust Bottles enabled it to level out the vehicle’s short flights even under fire, and applied just the right amount of feathering thrust to prevent each leap from becoming an airskirt-rending “bounce.”

As a tracking system, the AL2200 could also follow and target enemy units for the vehicle’s array of missiles and autocannon, even while executing a complex jump in combat. Though the AL2200’s capabilities were theoretically compatible with a turret assembly, the Kanga featured no such mount to keep its profile lower. Reportedly, however, the SLDF experimented with such an enhancement in a never-deployed variant dubbed the KGA-3X.

## Deployment

Of the estimated fifty Kangas remaining in the Inner Sphere before the Fourth Succession War, almost all were deployed by the Com Guards and—through defections following the schism of 3052—the Word of Blake. The Clans’ own limited supply of these vehicles apparently remains in mothballs even today, with few beyond the technicians of the Hell’s Horses interested

in reviving their concept for the modern day. It is believed that all of the Inner Sphere Kangas have been lost through various actions, with the last significant concentration of these vehicles destroyed during the fighting of the FedCom Civil War and among the devastating casualties of ComStar’s Case White operation in the early Jihad.

## Variants

No production variant of the Kanga ever hit the field, though numerous one-offs emerged through the decades following the Star League’s collapse and the gradual loss of components for the AL2200 system. Through the First and Second Succession Wars, many of the Kangas made by Mitchell Vehicles declined sharply, some losing their jump capability and others suffering from a failure of their airskirts, reducing them to simple “jump tanks.”

Clan Hell’s Horses reportedly attempted to produce an upgraded version of the Kanga, resulting in the Hephæstus OmniVehicle, but abandoned the jump capability on the grounds of the prohibitively expensive AI system. Rumors abound, however, that a renewed interest in the concept, based on Wing-in-Ground Effect technology, may yet breathe new life into the Clan’s hopes for a viable Kanga alternative.

## Notable Crews

**Adept Richard McGivers:** A Kanga commander in the Loyal Subjects, part of the breakaway Com Guard forces that formed the so-called Prince’s Men during the FedCom Civil War, Adept McGivers led the last complete Level II’s worth of the venerable hover-jump tanks during the fighting on Halfway in 3064. During the fierce battle against Katherine-loyal militia forces, McGivers’ Kanga accounted for three vehicle kills and an assist on a militia *Falconer* before his Kanga—the “Immortal Hopper”—suffered crippling damage to its airskirt. In a valiant last-ditch effort to take one more pro-Katherine unit with him, McGivers (the only survivor of his vehicle’s four-man crew) executed a final death from above attack with his stricken Kanga that disabled a militia *Commando* at the cost of his ancient vehicle.

Type: **Kanga**  
 Technology Base: Inner Sphere  
 Tonnage: 50  
 Battle Value: N/A

**Equipment**

		<b>Mass</b>
Internal Structure:		5
Engine:	165	12
Type:	ICE	
Cruise MP:	8	
Running MP:	12	
Jumping MP:	6	
Heat Sinks:	0	0
Control Equipment:		2.5
Lift Equipment:		5
Power Amplifier:		0
Turret:		0
Armor Factor:	56	3.5
	<i>Armor Value</i>	
Front	20	
R/L Side	12/12	
Rear	12	

<b>Weapons and Ammo</b>	<b>Location</b>	<b>Tonnage</b>
Autocannon/5	Front	8
Ammo (AC) 20	Body	1
LRM 10	Front	5
Ammo (LRM) 12	Body	1
SRM 4	Front	2
Ammo (SRM) 25	Body	1
Machine Gun	Front	.5
Ammo (MG) 100	Body	.5
Jump Jets	Body	3

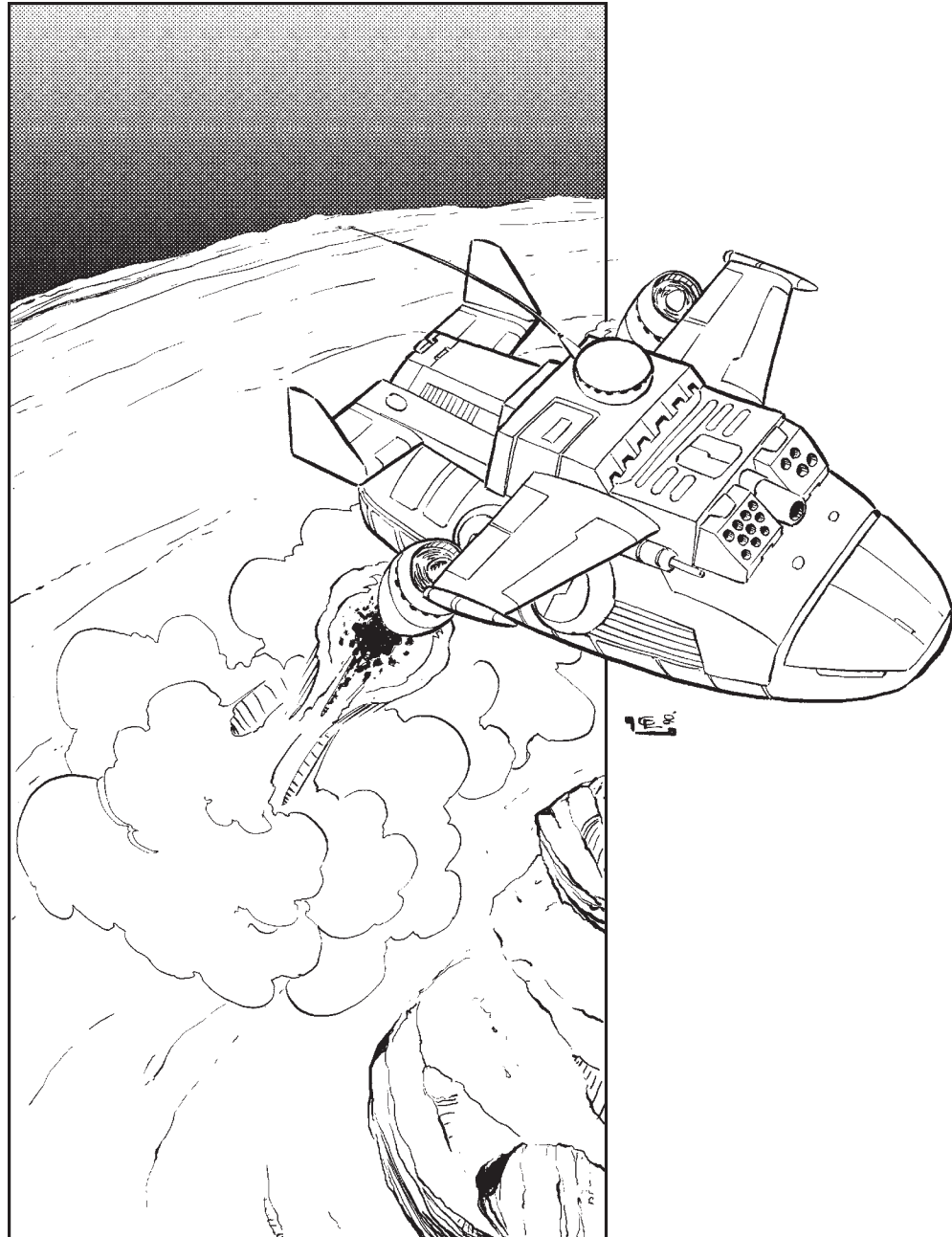

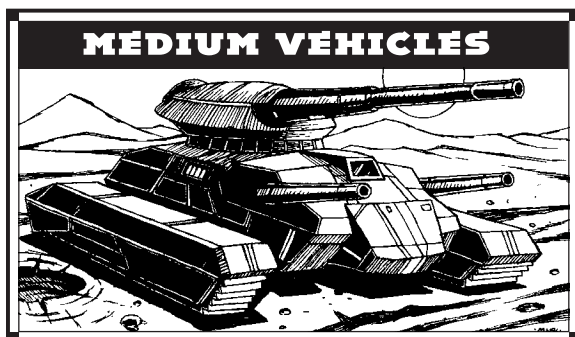

**Mass:** 55 tons

**Movement Type:** Wheeled

**Power Plant:** Strand 255

**Cruising Speed:** 54 kph

**Flank Speed:** 86 kph

**Armor:** Ulston 105 Ferro-Fibrous with CASE

**Armament:**

- 1 Thumper Artillery Piece
- 2 Magna LT Medium Lasers

**Manufacturer:** Ulston Armor

**Primary Factory:** Terra (destroyed 2777)

**Communications System:** Redstar III

**Targeting and Tracking System:** TBR LaserTrac

## Overview

Speed and aggression were central to the SLDF's fighting doctrine, countering the abilities of opponents technologically and tactically. On the fluid battlefields of the 27th and 28th centuries, bringing firepower to bear quickly and efficiently was a key part of this and while 'Mechs and armor were effective fighting tools, they lacked the range and raw firepower that emplacement-based weaponry could provide. Traditional mobile artillery was too slow to meet the SLDF's demands, and so the Quartermaster Command commissioned a fighting platform that could move artillery to where it was needed in a timely manner and could also redeploy quickly to avoid enemy counter-battery fire.

More than a dozen designs were put forward and several manufactured as prototypes to be tested in battlefield conditions. The winning candidate was the Thor artillery carrier, the only one of the finalists to achieve

the speed required by the SLDF brief. While not as heavily armored as other designs nor as well equipped for self-defense or as capable in rough terrain, it could keep up with the leading SLDF units and support their operations. The design entered service in 2680 and remained a staple of the League's forces until the Kerensky Exodus.

## Capabilities

While the armor coverage of the Thor isn't exceptional for its weight class—though the ferro-fibrous compound offers above-average protection—a combination of speed and agility safeguard the vehicle. As well as being capable of speeds over 80 kph, the SLDF mandated speed, the Thor can be underway within thirty seconds of firing its massive Thumper cannon, a significant improvement over other field artillery pieces that need minutes (or in some cases hours) of preparation time, thus making counter-battery fire against them difficult. In the rare eventuality of the Thor taking significant damage, a well-designed crew compartment minimizes their exposure to harm, while a CASE system directs any ammunition brew-ups away from the crew.

The Thumper cannon forms the centerpiece of the Thor's armament, the gunner having direct access to the communications array for ease of relaying information to spotters. Auto-loading gear speeds the cannon's operation and allows the Thor to lay down a devastating rain of shells. Though of smaller caliber than other artillery pieces, this is more than compensated by its mobility and ease of use, allowing the Thumper-equipped Thor to hurl barrages against targets up to seven kilometers away.

Although the Thor is not intended as a frontline combatant, the flexible nature of the forward edge of battle means the Thor occasionally finds itself in harm's way. It is thus equipped with twin medium lasers for self-defense, both mounted on a crane-like turret assembly, but the vehicle's greatest protection is its speed and ability to avoid combat.

## Deployment

The SLDF fielded hundreds of Thors and also exported them to the house militaries. The Star League

models served with distinction in the war against Amaris though it massively thinned their numbers and the last known examples left with Kerensky. The models employed by the Great Houses were likewise culled by the Succession Wars, and by the end of the Second Succession War the Thor had largely disappeared from the Inner Sphere militaries.

## Variants

A considerable stockpile of SLDF material came into ComStar's hands after the collapse of the Star League and among that equipment were examples of the Thor. These remained hidden for centuries but played a role in the battles on Tukayyid that halted the Clan invasion. Most of these models adhere to the classic Star League configuration (as do the examples seen with Clan second-line forces, though these may employ Clan versions of the lasers and construction materials) but some have made use of recovered and newly developed technologies. The most significant of these builds on the advanced communications gear of the Thor and removes the turret, using the mass freed up to install a C<sup>3</sup>i system. This allows the Thor and its teammates—spotter vehicles and other Thors—to share targeting information directly from their fire-control systems, resulting in vastly enhanced fire-coordination and accuracy.

## Notable Crews

**Adept James Larson:** During the battles for control of Spanac and Luk on Tukayyid, Adept Larson and his Thor crew played a significant role against the Ghost Bears, employing the range of their main gun to harass Clan supply caches and assembly points with relative ease. Larson received a commendation for this contribution and later went on to serve on Schuyler and Huntress, witnessing the Great Refusal with his colleagues in the Ninety-first Division.



# THOR ARTILLERY VEHICLE

Type: **Thor Artillery Vehicle**  
 Technology Base: Inner Sphere  
 Movement Type: Wheeled  
 Tonnage: 55  
 Battle Value: N/A

<b>Equipment</b>		<b>Mass</b>
Internal Structure:		5.5
Engine:	255	19.5
Type:	Fusion	
Cruising MP:	5	
Flank MP:	8	
Heat Sinks:	10	0
Control Equipment:		3
Lift Equipment:		0
Power Amplifier:		0
Turret:		.5
Armor Factor:	125	7
	<i>Armor Value</i>	
Front	29	
R/L Side	23/23	
Rear	22	
Turret	28	

<b>Weapons and Ammo</b>	<b>Location</b>	<b>Tonnage</b>
Thumper Artillery Piece	Front	15
Ammo (Thumper) 40	Body	2
CASE	Body	.5
2 Medium Lasers	Turret	2

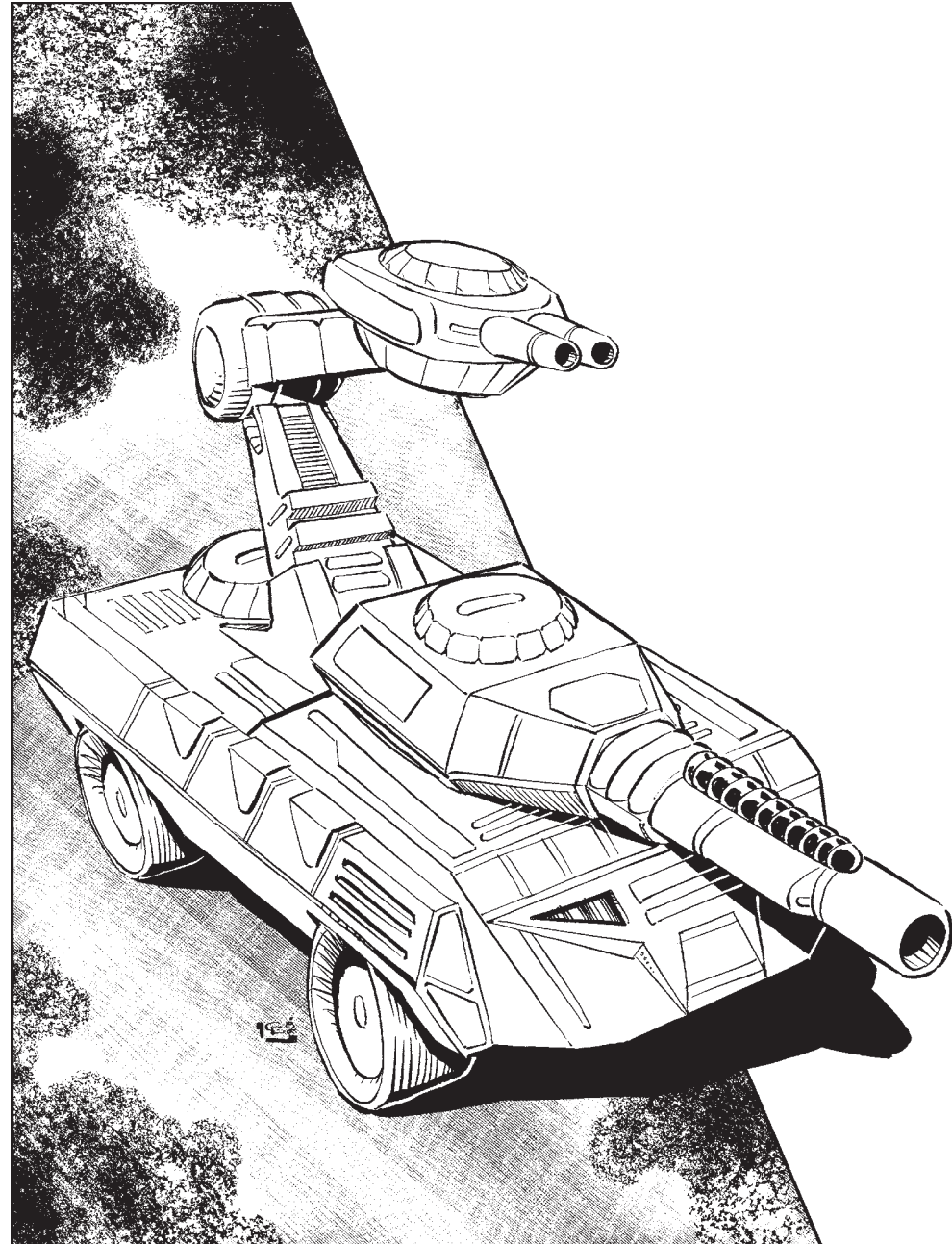

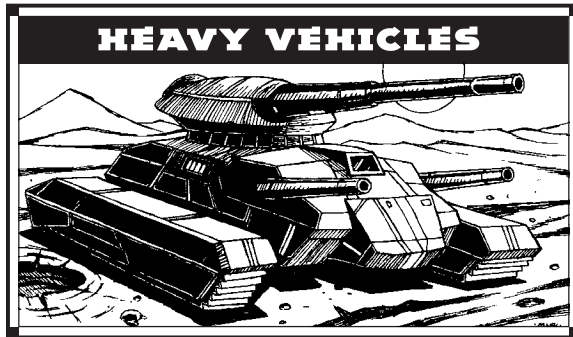

**Mass:** 60 tons

**Movement Type:** Wheeled

**Power Plant:** DAV 220

**Cruising Speed:** 43 kph

**Flank Speed:** 64 kph

**Armor:** PanzerSlab 2

**Armament:**

1 M-7 Gauss Rifle

2 Intek Medium Lasers

1 Harpoon-6 SRM 6

**Manufacturer:** Leopard Armor

**Primary Factory:** Terra

**Communications System:** Teledon 19

**Targeting and Tracking System:** Baltex K590

## Overview

Once the standard fighting vehicle of the original Star League, the Demon is also used heavily by both the Com Guards and, more recently, the Word of Blake. The sheer numbers seen since the start of the Jihad has led many to suspect that the once-destroyed Leopard Armor plant on Terra has, in fact, been re-opened for some time.

## Capabilities

Mounting an efficient DAV 220 fusion power plant, the Demon can keep up with most heavy formations on suitable terrain, and the ten tons of armor gives the fighting vehicle protection that rivals most BattleMechs. The big punch from the heavy wheeled combat vehicle comes from a turret-mounted Gauss rifle backed up by

a heavy SRM pack on the nose of the vehicle. A medium laser on each side of the Demon protects it from being flanked.

## Deployment

During the original Star League, SLDF units would deploy Demons in pairs hidden in hedged fields or alleyways. They would sit for days patiently awaiting their prey to appear, then the pair would erupt. This tactic was so successful that the Demon was quickly adopted as the standard fighting vehicle of the Defense Force.

The Com Guards attempted this tactic with the Clans on Tukayyid but quickly found it to be lacking against the Clan's advanced technology. They enlarged the ambush teams to include a third Demon and the Demon remained one of the preferred vehicles of the Com Guards and, later, the Word of Blake. In any sizeable engagement that has involved a WoB or Com Guard vehicle force, a Demon—often many of them—has participated. Most Protectorate militias, upon being formed, are gifted with a Level III of Demons, making them unusually well equipped for a mere militia unit.

## Variants

The Star League also attempted to create a variant intended for units that typically conducted extended campaigns away from re-supply, often to hold out until reinforcements arrived. Known as the Horned Demon, it replaced all of the secondary weapons and the CASE with four forward mounted medium lasers and an extra half-ton of armor. This version was not nearly as widespread as the original, and after a few years it was abandoned.

The second SLDF attempt at a supply-independent Demon traded away all of the original weaponry for a pair of particle projection cannons, heat sinks, and a half-ton of cargo for crew supplies. While better received than the original Horned Demon, the limited versatility of the weaponry was still not widely favored. The dislike resulted in the second Horned Demon being relegated to Hegemony militia units by the mid-2700s, where it came to excel in its designated role

during the Amaris Coup. On one notable occasion, a pair of surviving Horned Demons managed to ambush Stefan Amaris's motorcade as he toured the California coast. Only Amaris's last-minute whim of getting better perspective on the Big Sur coastline from the cockpit of an escorting BattleMech saved him when his limousine was evaporated; the pair of Demons then proved to be no match for Amaris's heavy escorts.

Many Demons have been spotted in the last year in a new configuration. Without a turret, this model mounts a heavy Gauss rifle in front backed by a Streak-6 SRM launcher. The medium lasers on the side are now extended range, and operatives have discovered it mounts not just an improved C<sup>3</sup> node, but also an advanced targeting system. Analysts believe new ferro-fibrous composites are used, as lighter armor and an extra-light fusion engine needs to be employed to compensate for the weight of the massive cannon.

## Notable Crews

**Devil's Minions:** A Level II made up of mostly newer Demons, the crews of the Devil's Minions seem to take great joy in using the Lyran-developed weapon against the guerilla defenders on Tharkad. Pairing up like the original Star League, the teams stick together so they may support one another should one team find itself in trouble. Smuggled gun camera footage showed a heavy Royal Guards lance getting ambushed by the Devil's Minions in the Triad City, and within the first twenty minutes of combat the lance was withdrawing, leaving two crippled units behind. However, Wolfnet has learned that the Devil's Minions were effectively destroyed in the autumn of 3070 by the Eisenjagers, an elite Lyran tank group headhunting prominent Blakists.

Type: **Demon**

Technology Base: Inner Sphere

Movement Type: Wheeled

Tonnage: 60

Battle Value: 1,094

### Equipment

		Mass
Internal Structure:		6
Engine:	220	15
Type:	Fusion	
Cruising MP:	4	
Flank MP:	6	
Heat Sinks:	10	0
Control Equipment:		3
Lift Equipment:		0
Power Amplifier:		0
Turret:		1.5
Armor Factor:	160	10
	<i>Armor Value</i>	
Front	50	
R/L Side	30/30	
Rear	20	
Turret	30	

Weapons and Ammo	Location	Tonnage
Gauss Rifle	Turret	15
Ammo (Gauss) 16	Body	2
Medium Laser	Left	1
Medium Laser	Right	1
SRM 6	Front	3
Ammo (SRM) 30	Body	2
CASE	Body	.5

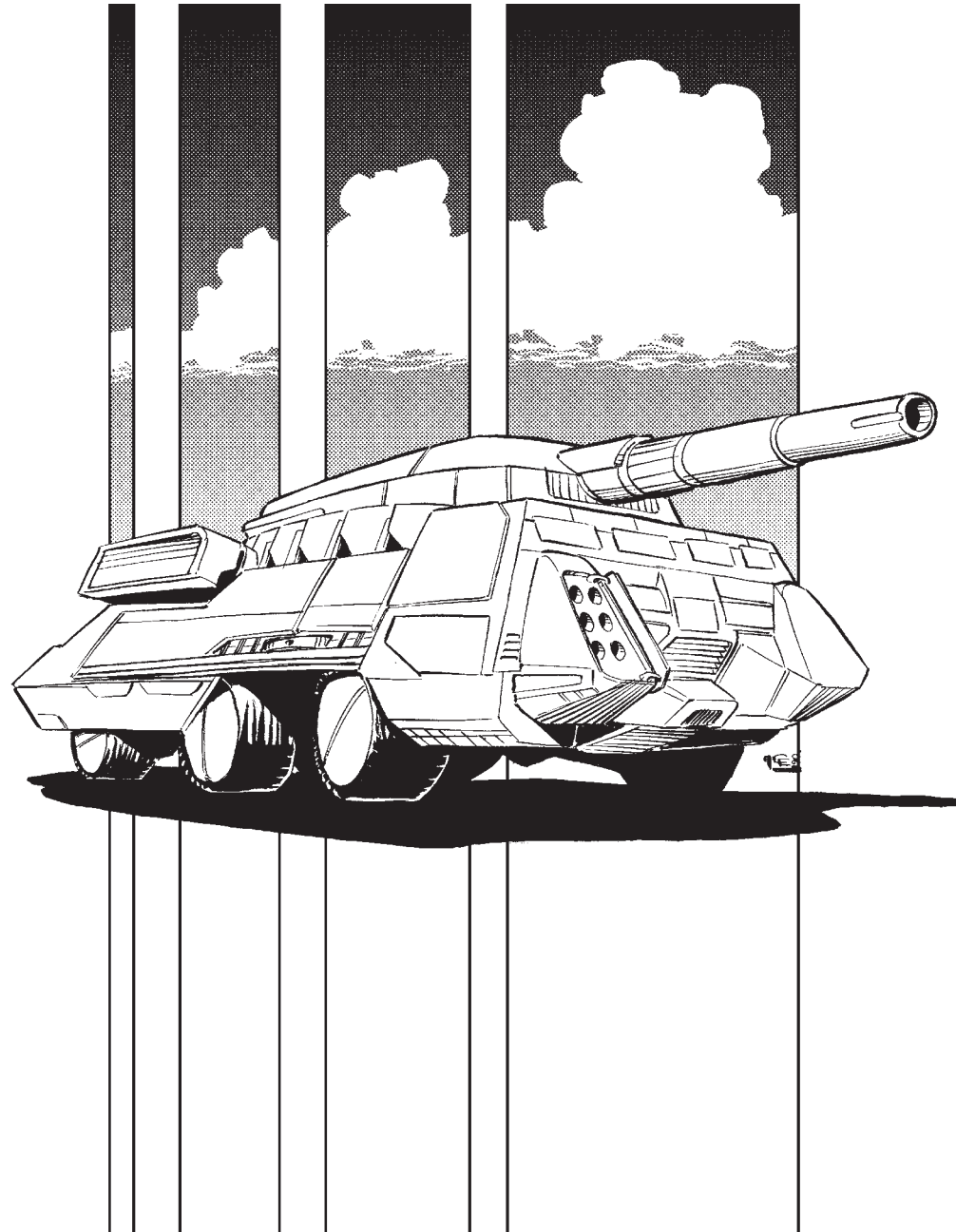

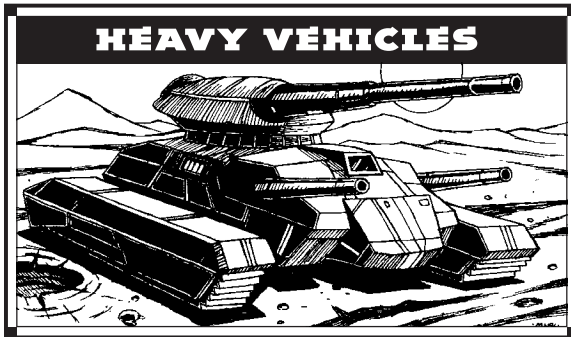

**Mass:** 65 tons

**Movement Type:** Tracked

**Power Plant:** Magna 260

**Cruising Speed:** 43 kph

**Flank Speed:** 54 kph

**Armor:** Grumman CRT Ferro-Fibrous

**Armament:**

1 Sniper Artillery Piece

1 RAMTech 500 Large Laser

**Manufacturer:** CrummanCRI

**Primary Factory:** Melissia

**Communications System:** O/P GRD 300

**Targeting and Tracking System:** O/P GRD059

## Overview

Considered a monumental failure when compared to the Thor Artillery Vehicle, the Marksman never received widespread use in combat. Though Grumman flooded the market with thousands of them during the Second and Third Succession War, the vehicle's lack of speed and close-in defense systems kept hundreds of this unit from combat. Instead, the Marksman fought the ages-old battles of time and decay.

The Marksman was initially conceived as a variant to the Thor, utilizing the heavier (and shorter ranged) Sniper Artillery Piece. The immense weight and recoil of the weapon forced designers to quickly abandon that avenue and look at developing an entirely new chassis. Switching from a wheeled to track suspension forced the designers to reduce its overall speed, though the more stable chassis allowed for greater balance and additional armor.

Still, the inclusion of a RAMTech large laser—though accurate even at long ranges—was rather odd, considering that the main weakness of artillery units is point defense. Only recently, when GrummanCRI (a recently developed merger between Grumman Industries and CRI Mechanical) revisited the Marksman, was it discovered that the dual computer system (which allowed the Sniper to be used as a deadly direct-fire weapon) was so poorly cooled that the system often had to reduce its processor speeds, limiting the number of targets the laser turret system could acquire. A simple failure to include a coolant sleeve or other dissipation method for the GRD series of tactical computers kept the Marksman from achieving any real battlefield success.

During Grumman's revamp of the tank, this oversight was eliminated along with the outdated tread lock and wheel system. As a result, the Lyran Alliance has a vastly improved artillery tank that may help make a difference on today's combined-arms battlefields.

## Capabilities

The original Marksman was incapable of outrunning its enemies, which meant that much of the vehicle's weight was dedicated to armor protection. The shorter-ranged Sniper artillery weapon deals a great deal of damage, though the recoil is still hard on the tank's suspension. Marksmen crewmembers need to complete a standard stress and load test every 150 combat hours in order to monitor for any wear. Failure could mean the complete breakdown of the tank's motive system—not an ideal situation during the heat of combat.

The sophisticated dual-computer tracking system allows both the new and older Marksman designs direct-fire capability. During the days of the Third Succession War, it was not uncommon to have savvy commanders hide Marksmen in abandoned buildings and fire point-blank into the flanks or rear of advancing enemy BattleMechs. Because of the Sniper's power, oftentimes only one shot was needed to seriously cripple or destroy light and medium BattleMechs.

## Deployment

The original Marksman has not been seen on the field of combat since the end of the Third Succession War. The last known functioning piece was in service to the Magistracy of Canopus as part of Valexa's small planetary militia.

Today, however, the new and improved Marksman has begun popping up in the Melissia Theater as a strong backbone to those Lyran Alliance units facing Clan Jade Falcon. It is unknown if GrummanCRI plans to export the tank to other militaries—considering the new company's heavy leaning to all things Lyran, this is unlikely to happen any time soon.

## Variants

The new Alliance-built Marksman takes advantage of a light fusion engine and recently developed light ferro-fibrous armor. The large laser is removed, and a newer light PPC system paired with two heavy machine guns resides in the turret situated behind the Sniper cannon. Two additional heavy machine guns are mounted in the front of the tank; these guns are remotely controlled by the driver.

## Notable Crews

**Fist of Justice:** This lance of newer Marksmen is part of the First Skye Rangers' artillery company. The four tanks have yet to suffer a casualty in the past four years of fighting and have accounted for no less than sixty BattleMech and vehicle kills. When possible, the unit likes to be placed immediately behind the front lines in order to bring their large Sniper cannons into the fray. Necessity occasionally pushes the Fist to work with several VTOL units who act as spotters, though the vehicle crews prefer to work "up close and personal." At least two of the Fists' vehicle commanders are former MechWarriors who seem to take great pleasure in taking down assault 'Mechs with concentrated fire.

Type: **Marksman**  
 Technology Base: Inner Sphere  
 Movement Type: Tracked  
 Tonnage: 65  
 Battle Value: N/A

**Equipment**

		<b>Mass</b>
Internal Structure:		6.5
Engine:	260	20.5
Type:	Fusion	
Cruising MP:	4	
Flank MP:	6	
Heat Sinks:	10	0
Control Equipment:		3.5
Lift Equipment:		0
Power Amplifier:		0
Turret:		.5
Armor Factor:	125	7
	<i>Armor Value</i>	
Front	49	
R/L Side	19/19	
Rear	19	
Turret	19	

<b>Weapons and Ammo</b>	<b>Location</b>	<b>Tonnage</b>
Sniper Artillery Piece	Front	20
Ammo (Sniper) 20	Body	2
Large Laser	Turret	5

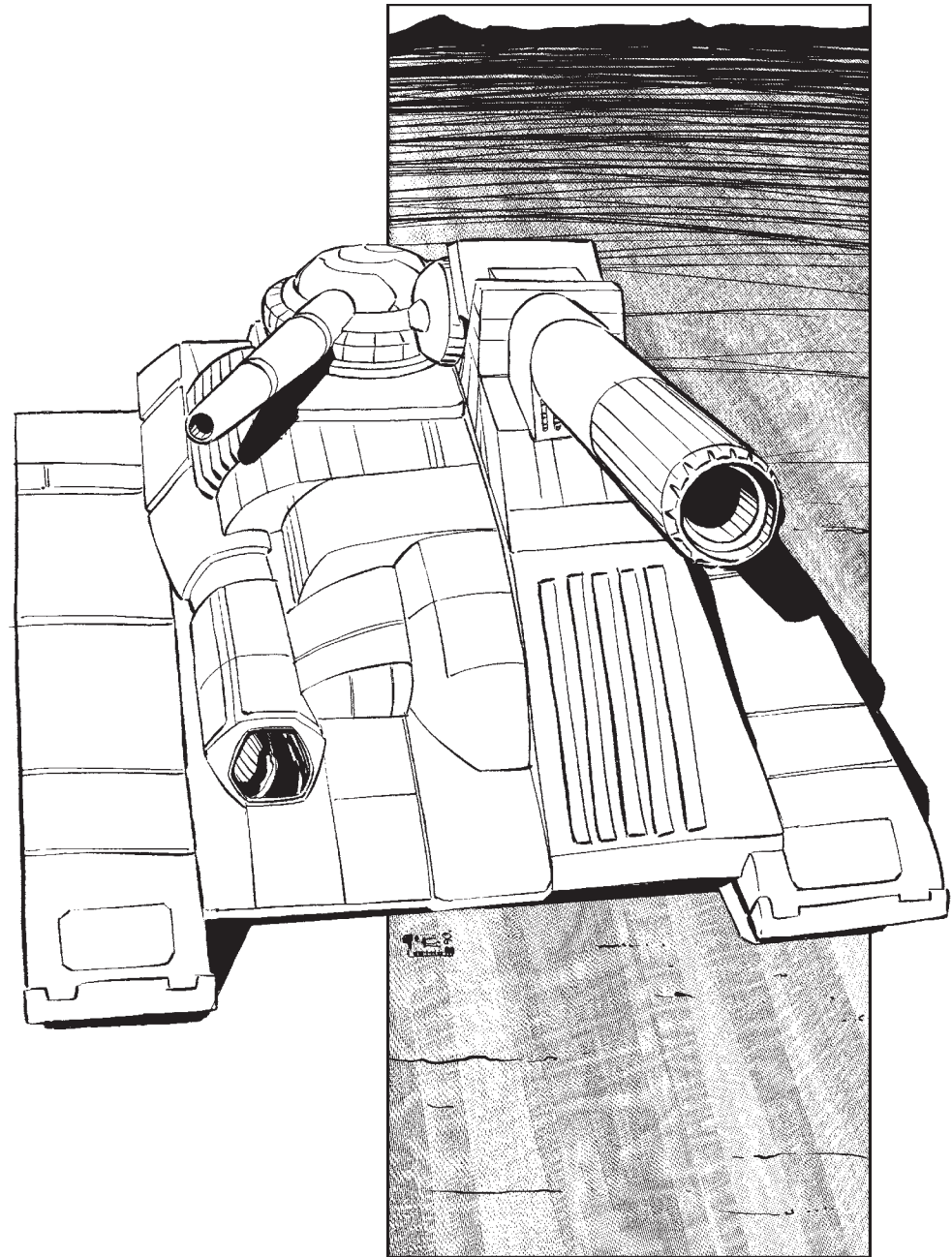

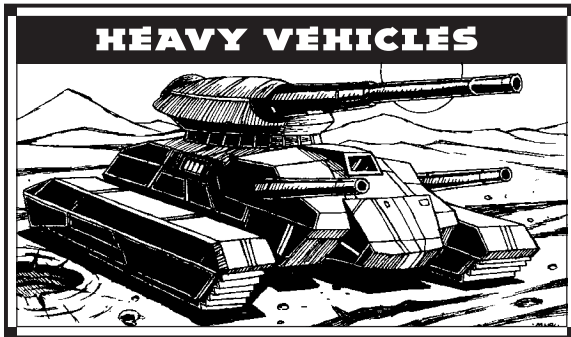

**Mass:** 70 tons  
**Movement Type:** Tracked  
**Power Plant:** Magna 350  
**Cruising Speed:** 54 kph  
**Flank Speed:** 86 kph  
**Armor:** Killosh Xtra-Weave Ferro-Fibrous  
**Armament:**  
 3 Randall Hellbitch Medium Lasers  
 2 Ramsey-65 Machine Guns  
**Manufacturer:** Killosh Industries  
**Primary Factory:** Bharat  
**Communications System:** Hesperus 5GT  
**Targeting and Tracking System:** Lynx RM

### Overview

Plagued with growing civil unrest in the Periphery territories, the SLDF required a dedicated infantry support vehicle. Competition for the contract was fierce, but smart money was on Leopard Armor's twenty-five-ton Prowler winning the contract. It thus came as a surprise when General Aaron Clavy of the Quartermaster Command announced that Killosh Industries' far heavier Magi had been selected.

Six months later the scandal that became known as the "Gift of the Magi" broke. Tempest Halloran, the chief executive of Killosh Industries and General Clavy had secretly been friends for many years. When this fact was uncovered by a Lyran reporter, all testing was halted and a full investigation was launched. When the eighteen-month long inquiry failed to uncover any wrongdoing or special treatment, testing resumed. The

Magi performed well enough to silence its critics and Killosh Industries began full-scale production in 2727. Though a capable vehicle, the Magi suffered from poor sales and Killosh eventually filed for bankruptcy prior to the fall of the first Star League.

### Capabilities

Although looking slightly odd without a turret, the Magi's low profile makes it a harder target and enables it to more easily navigate urban environments. Although weighing in at a hefty seventy tons, the vehicle is surprisingly fast thanks to a massive Magna 350 fusion engine. The Killosh Xtra-Weave armor was developed for use on BattleMechs, and its use on the Magi uncovered some flaws, with abrupt maneuvers causing cracks to appear between the armor plates. This can lead to weapon hits inflicting more damage, but as the vehicle is protected by almost ten tons of armor, most crews consider it to be an acceptable tradeoff. The inclusion of CASE to protect the machine gun magazine further enhances protection given the crew of five.

Speed and protection come at a cost. In the case of the Magi, this is in weaponry. Three lasers and a pair of machine guns are a popgun armament compared to the arsenal carried by the Von Luckner or Burke. With attacks from almost any direction likely, the Magi compensates for its lack of a turret by mounting two of its three Randall Hellbitch medium lasers on the left and right of the vehicle. Two front-mounted Ramsey-65 machine guns have become legendary for their ability to maintain a murderous rate of fire. These are linked to an advanced Lynx RM targeting system. The sophisticated fire-control system can allow a single gunner to manage all the weapons if necessary. Normally the vehicle carries three gunners, in addition to a commander and driver.

### Deployment

The Magi was deployed in numbers with SLDF Mechanized Infantry Divisions assigned to the Periphery theater. Under attack from increasingly well-equipped and organized insurgents, the League troops

found the heavily armored Magi to be an invaluable asset. The Magi fared less well in the brutal campaign to liberate the Terran Hegemony from its Rim Worlds occupiers. Where the light weaponry was adequate for battling paramilitary forces in the Taurian Concordat, it was woefully inadequate for the battles fought in the campaign to liberate Terra.

Like so many other Star League-era designs, the Magi resurfaced amongst the ranks of the Com Guards, where it works well with the Guards' combined-arms doctrine. Though unable to stand against Clan OmniMechs, the Magi's speed and armor allowed it to provide effective support to Com Guard infantry facing Clan Elementals.

The Word of Blake has deployed an updated version of the Magi to maintain peace on the city streets of their Protectorate. The vehicle is becoming a common sight amongst the ranks of the Blake Protectorate Militia.

### Variants

The Word of Blake technicians have modified the basic Magi chassis to better suit their needs, transforming it into an urban combat support vehicle. The Magna 350 engine has been replaced with a new light model, and the mass freed up has been used to add a C<sup>3</sup>i computer and a six-ton infantry bay (which causes notable changes in the hull's lines). Two additional machine guns have been added, and ammunition capacity has been increased by fifty percent. All four machine guns have been tied together in a single machine gun array.

### Notable Crews

**Force of Wisdom:** Crewed by Adepts David Yong, Chris Porter, Janice Steel, Stan Owens, and Elizabeth Quinn, Force of Wisdom was instrumental in putting down an attempt by insurrectionists to seize the Caph parliamentary buildings in early 3070. With Blakist front line forces becoming stretched there is talk of transferring Force of Wisdom and its crew to the Eighth Division.

Type: **Magi**  
 Technology Base: Inner Sphere  
 Movement Type: Tracked  
 Tonnage: 70  
 Battle Value: 798

### Equipment

		<b>Mass</b>
Internal Structure:		7
Engine:	350	44.5
Type:	Fusion	
Cruising MP:	5	
Flank MP:	8	
Heat Sinks:	10	0
Control Equipment:		3.5
Lift Equipment:		0
Power Amplifier:		0
Turret:		0
Armor Factor:	170	9.5
	<i>Armor Value</i>	
Front	44	
R/L Side	43/43	
Rear	40	

<b>Weapons and Ammo</b>	<b>Location</b>	<b>Tonnage</b>
Medium Laser	Front	1
Medium Laser	Right	1
Medium Laser	Left	1
2 Machine Guns	Front	1
Ammo (MG) 200	Body	1
CASE	Body	.5

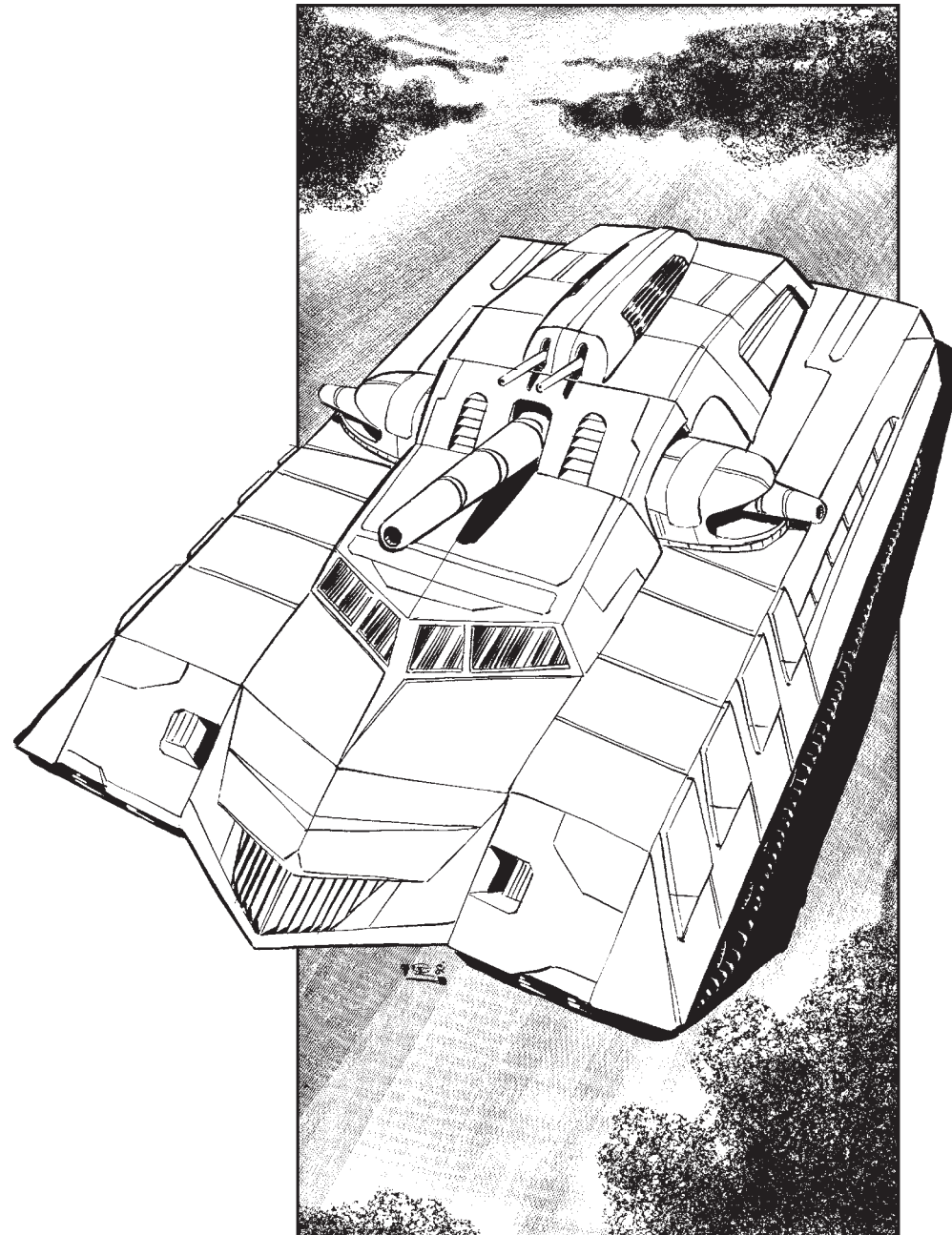

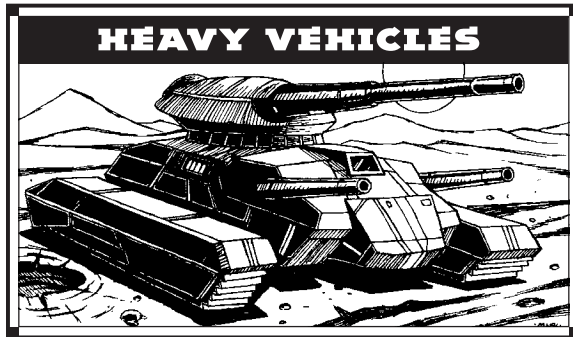

**Mass:** 75 tons

**Movement Type:** Tracked

**Power Plant:** GM 150

**Cruising Speed:** 21 kph

**Flank Speed:** 32 kph

**Armor:** Acbar 55 Ferro-Fibrous

**Armament:**

3 Chalker Model 25 PPCs

1 Holly LRM-10 Missile Rack

**Manufacturer:** Foretechno (Leopard Armor)

**Primary Factory:** Terra (destroyed 2778)

**Communications System:** 1 Division 300

**Targeting and Tracking System:** Scope 30 RNDST

## Overview

Plunged into the Reunification War, the fledgling Star League Defense Force found itself in a conflict that it was ill equipped to fight. Having inherited the Age of War's tactical doctrine and equipment, the League began to look for new weapons systems. The result was an explosion of new BattleMech, fighter, and vehicle designs.

Anticipating the needs of the newly created Star League, Foretechno's engineers began development of what would become the Burke at their Maranello works on Terra in 2575. Five years of development and testing would pass before the new vehicle began to fill the ranks of the SLDF's heavy tank regiments.

## Capabilities

Intended primarily for static defense duty, the Burke sacrifices speed for exceptionally heavy fire-

power. Armed with three powerful particle cannons and a hull-mounted LRM system, the tank is fully capable of killing a BattleMech at long range with a single salvo. A triple strike from the turret-mounted PPCs can disrupt communications and targeting systems temporarily, and in extreme cases the electromagnetic interference can overload a 'Mech's computers. Star League engineers moved quickly to add dampers to their 'Mech designs, but the League member states would not gain access to this refinement until the outbreak of the Succession Wars.

The Burke's main weakness is its inability to hold up in a prolonged engagement. In a quick fight against a single BattleMech, it can hold its own. When faced with multiple opponents, however, the Burke is hobbled by poor maneuverability and relatively light armor.

## Deployment

With demand being fuelled by SLDF's needs for more and better equipment to fight the Reunification War, Foretechno continued full-scale production for ten years. The Burke quickly became the backbone of the SLDF's heavy tank regiments, with many commands fielding a whole battalion of these deadly vehicles. Soon Periphery commanders were shaping their tactics to bypass dug-in Burkes rather than face them head on. However, as the conflict dragged on, the SLDF began to modify its tactics, culminating in the formation of the highly mobile Striker regiments. With its limited mobility the Burke was ill suited to the evolving combat style. Foretechno's orders fell as their tank began to be relegated to garrison duty.

Production continued sporadically, but the uneven demand caused Foretechno serious financial problems. With thousands of Burkes still in service the SLDF Quartermaster Command became concerned by the potential havoc of trying to maintain the vehicles if the company were to go bankrupt. Ultimately they were forced to take action in 2755. After buying out the shareholders, the Quartermaster Command restructured the company before handing its assets over to Leopard Armor. In return Leopard guaranteed to continue to support the SLDF's Burkes.

When the Star League fell, many Burkes fell into the hands of the other Inner Sphere powers. But without the support of Leopard Armor none of them survived the Succession Wars. It was not until the formation of the Com Guards that the design would be seen once more in the Inner Sphere. Following the ComStar schism the design can also be found in the ranks of the Word of Blake.

Alone amongst the Clans, the Hell's Horses field significant concentrations of combat vehicles. Many Burkes (relics of the SLDF Exodus) serve in their heavy armor Stars.

With no new vehicles being constructed it is possible that the conflict currently enveloping the Inner Sphere will be the Burke's last campaign.

## Variants

Foretechno made no major changes to their vehicle, being content to issue periodic sensor and comm system upgrades to keep pace with improvements in battlefield ECM.

Following the start of the Blakists' war, both the Word of Blake and ComStar have upgraded many of their Burkes. All three PPCs have been replaced with two Supernova Heavy PPCs, and the LRM launcher has been swapped out for a Holly Streak SRM-4 and two tons of ammunition. The installation of a C<sup>3</sup> unit allows the upgraded vehicle to operate as part of a C<sup>3</sup> network.

## Notable Crews

**Major Domic Foil:** A young Foil joined the SLDF amidst the early optimism that the Reunification War would be a brief but glorious endeavor. Lacking the aptitude to become a MechWarrior, he was assigned to the Twenty-seventh Heavy Regiment. Foil won the Star League Medal of Honor in 2582 at the Battle of Shandra's Gap, where his lone Burke held off an entire Taurian armor column. As the conflict dragged on he rose steadily through the ranks, finally assuming command of the regiment's Second Battalion.



Type: **Burke**  
 Technology Base: Inner Sphere  
 Movement Type: Tracked  
 Tonnage: 75  
 Battle Value: 815

**Equipment**

		<b>Mass</b>
Internal Structure:		7.5
Engine:	150	8.5
Type:	Fusion	
Cruising MP:	2	
Flank MP:	3	
Heat Sinks:	30	20
Control Equipment:		4
Lift Equipment:		0
Power Amplifier:		0
Turret:		2.5
Armor Factor:	98	5.5
	<i>Armor Value</i>	
Front	27	
R/L Side	18/18	
Rear	15	
Turret	20	

<b>Weapons and Ammo</b>	<b>Location</b>	<b>Tonnage</b>
3 PPC	Turret	21
LRM 10	Front	5
Ammo (LRM) 12	Body	1

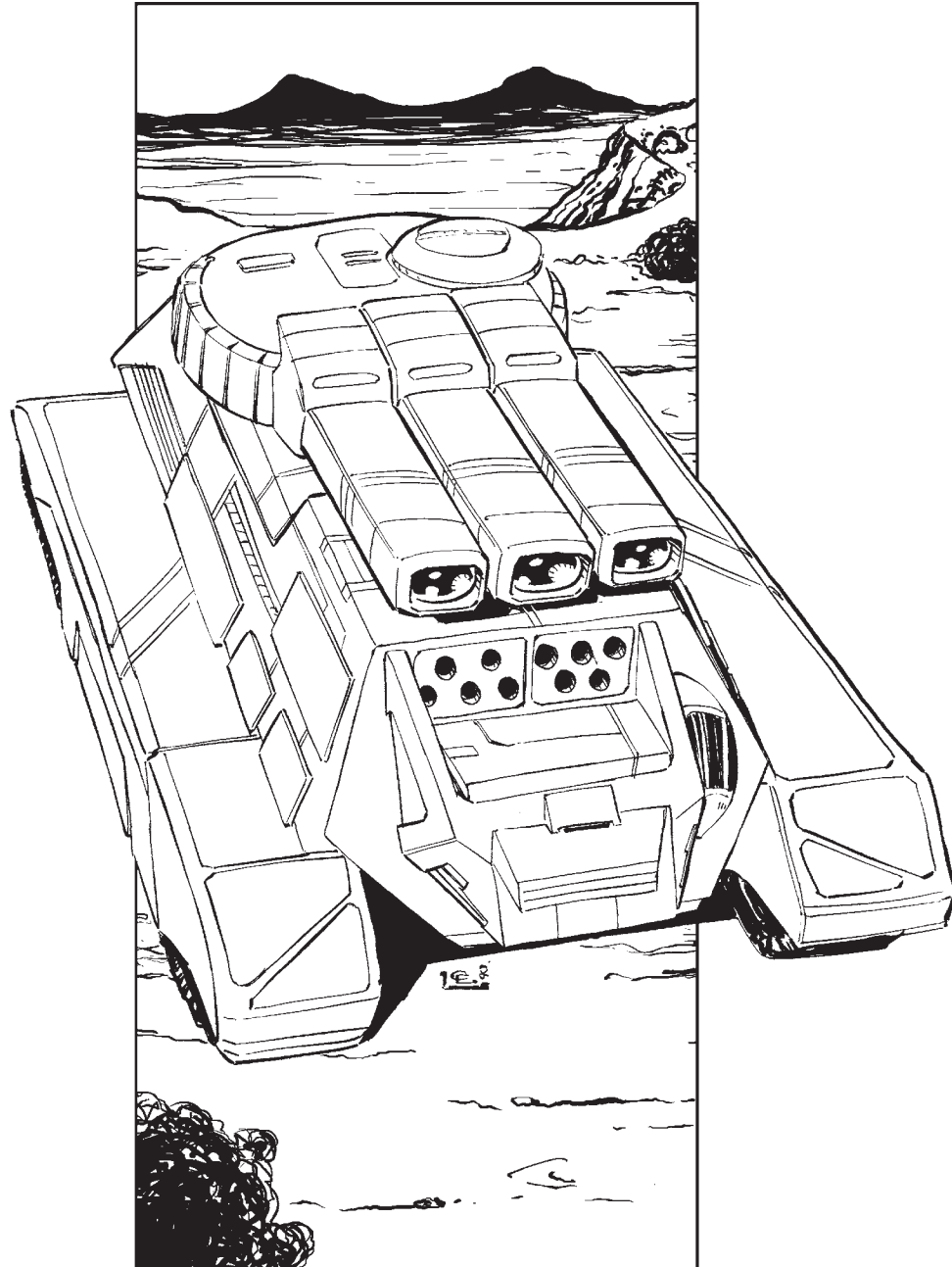

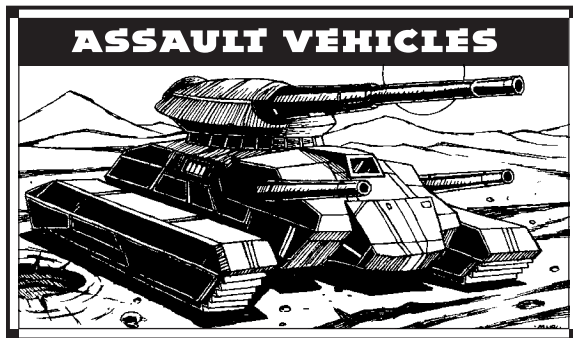

**Mass:** 80 tons

**Movement Type:** Tracked

**Power Plant:** Pitban 320

**Cruising Speed:** 43 kph

**Flank Speed:** 64 kph

**Armor:** PyroTec ArmorSlab Standard

**Armament:**

1 Poland Main Model C Gauss Rifle

**Manufacturer:** Jolassa-Kumbold Armored Weapons

**Primary Factory:** Bristol

**Communications System:** HIV-13

**Targeting and Tracking System:** Quadrant XD

## Overview

Though the Fury was originally considered a superior command and control vehicle for infantry and tank regiments, it has recently come to light that much of ComStar's original information regarding the machine was incomplete. The cause of the error is unknown, but the timing of it dates back to the technical data used in the failed attempt by Jolassa-Kumbold Armored Weapons (Jolassa Armored Vehicle's successor) to replicate the original design. The master set of technical information was lost when Jolassa's sole Fury assembly plant was partially destroyed in a nuclear fireball by the Combine in the opening salvos of the First Succession Wars, and the last recorded Fury in the Inner Sphere was blown to scrap in an engagement between the Confederation and the Federated Suns in the Second Succession War. Lacking a model to reverse engineer, the Fury faded into obscurity, one more piece of technology lost.

During a routine archeological dig sponsored by Interstellar Expeditions on the original factory site in 3068, everything changed. Buried deep below the surface of the factory's foundation a massive storage vault was discovered, rivaling the size of the Breed Castle Brian. After several weeks of excavation, researchers opened the vault to find a full company of pristine Furys and other Jolassa weaponry. After the initial furor died down—and a sudden attack from a WOB hunter-killer unit failed—JKAW transported the contents of the bunker to a secret R&D facility. Months later, a preliminary report by JKAW scientists proved that the original information supplied by ComStar was in error in key places that prevented the replication of such a marvel of military technology.

A further report by MIIO revealed that the vaunted Nirasaki-400X battle computer was a precursor to the Word of Blake and ComStar's advanced C<sup>3</sup> computer network. With some work, JKAW modified the original design, which had some unutilized growth room, to fit an infantry bay before putting it to market. Later, JKAW took advantage of 31st century C<sup>3</sup> technology and new weapon systems to update the Fury.

## Capabilities

Armed with a state-of-the-art battle computer that skirted the fringes of AI, the Fury was originally designed as a command tank for infantry and tank support units. Capable of transporting a small number of troops for its own defense, the Fury also mounted fourteen and a half tons of armor and the now-defunct M-9 Gauss system. Consistently successful in its role, Furys were frequently the target of concentrated airstrikes and BattleMech assaults aimed at removing it from the battlefield. Because of this, no Fury survived the Second Succession War.

## Deployment

Currently, the newer Fury tanks are being sold at cost to the AFFS. JKAW executives have pledged their complete support behind the throne of the Princess Regent and the AFFS; because of their dogged determination, all other offers by outside military forces have been refused, no matter how profitable.

## Variants

The first variant created by JKAW upgraded the armor to a ferro-fibrous weave and removed the Pitban 320 engine for an Alliance-manufactured light fusion version. The removal of the old (and now clunky) Nirasaki computer and the infantry bay gave designers room to install a C<sup>3</sup> network slave, add an additional ton of Gauss ammo and a light autocannon/5 series. Two extra tons of armor gave the Fury a slightly more bulky look but did not diffuse the enthusiastic response by AFFS tanker crews.

A C<sup>3</sup> master control version was also designed to work co-operatively with the slave-mounted version. Using a light fusion engine and ferro-armor weave, the Gauss system was also removed from the turret and replaced with the Federated Suns' new plasma rifle and a rotary class-5 autocannon. The original infantry bay was expanded as well, giving this new command vehicle added protection through a couple of squads of infantry or even some battle armor troops.

## Notable Crews

**Sniper Squad:** Collectively dubbed by the rest of the Davion Assault Guards, this six-man crew leads the first Fury company (or its remains, anyway) delivered to New Avalon between Blakist sieges. The crew has proven to be a frighteningly effective hunter-killer team as they escort the remaining lance of C<sup>3</sup>-equipped Furys, often outperforming their C<sup>3</sup>-enhanced compatriots. The Sniper Squad is noted for its tenacious retreat from the suburbs of New Avalon City, where Word of Blake units often zeroed in on the emissions of the C<sup>3</sup> Furys only to have the Sniper Squad's tank emerge from the rubble behind the WoB units to pour hypersonic shells into their backs.

Type: **Fury**  
 Technology Base: Inner Sphere  
 Movement Type: Tracked  
 Tonnage: 80  
 Battle Value: 1,184

<b>Equipment</b>		<b>Mass</b>
Internal Structure:		8
Engine:	320	34
Type:	Fusion	
Cruising MP:	4	
Flank MP:	6	
Heat Sinks:	10	0
Control Equipment:		4
Turret:		1.5
Armor Factor:	232	14.5
	<i>Armor</i>	
	<i>Value</i>	
Front	60	
R/L Side	39/39	
Rear	36	
Turret	58	

<b>Weapons and Ammo</b>	<b>Location</b>	<b>Tonnage</b>
Gauss Rifle	Turret	15
Ammo (Gauss) 16	Body	2
Infantry Bay	Body	1

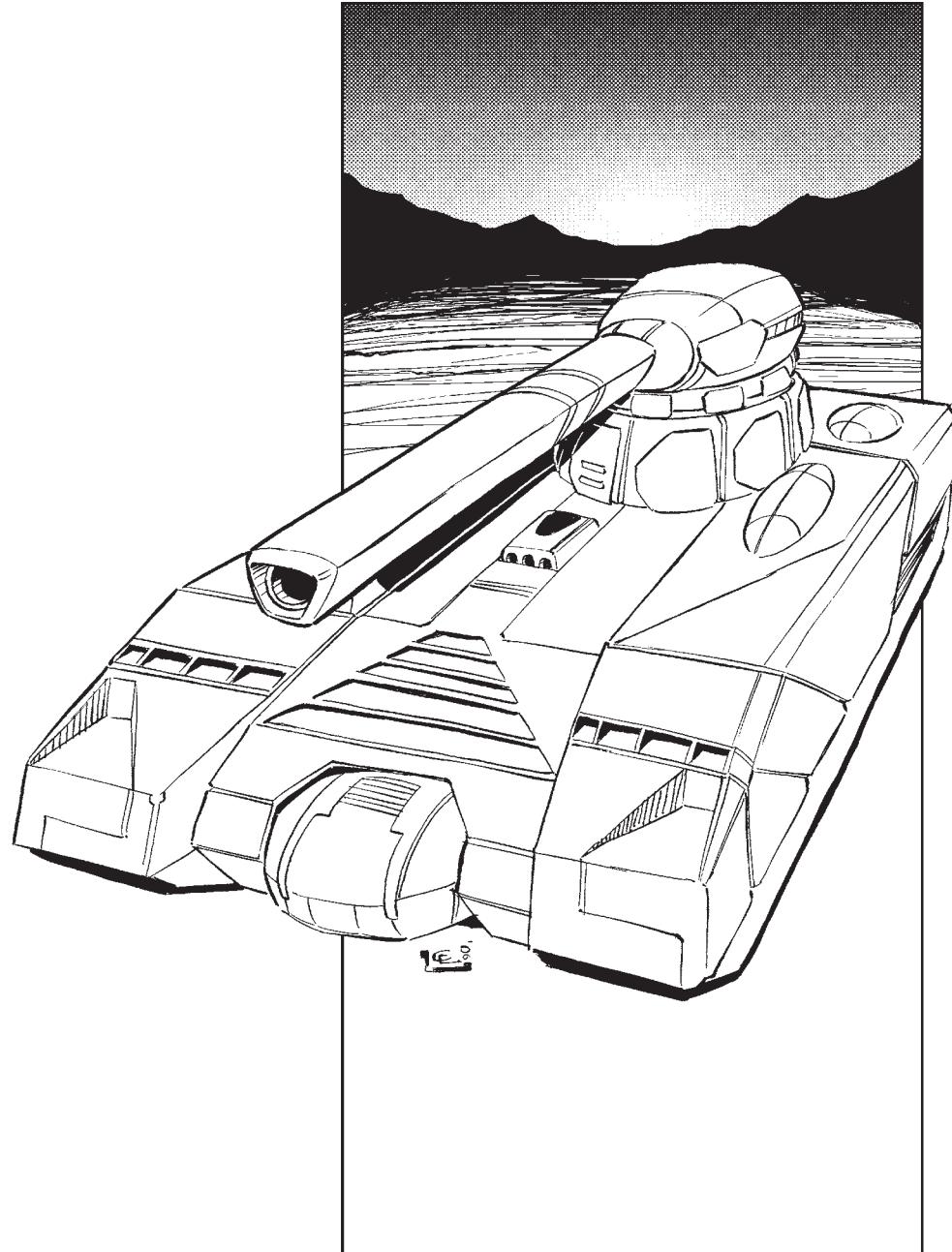

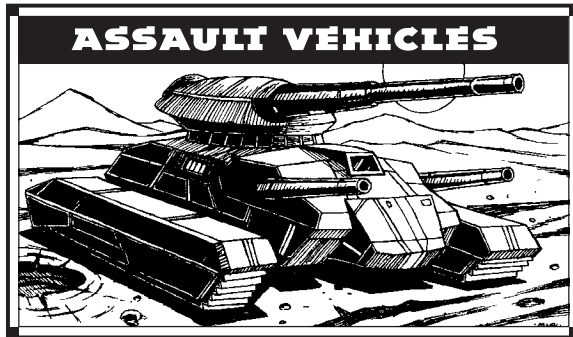

**Mass:** 80 tons

**Movement Type:** Tracked

**Power Plant:** Pitban 240

**Cruising Speed:** 32 kph

**Flank Speed:** 54 kph

**Armor:** Pantherskin VII

**Armament:**

2 Delta Dagger LRM-20 Missile Racks

2 Starflash Medium Lasers

1 Conan DT LRM-10 Missile Rack

**Manufacturer:** Leopard Armor

**Primary Factory:** Terra

**Communications System:** Trannel GL5

**Targeting and Tracking System:** Trannel OT73L

## Overview

Introduced in 2669, the Rhino was designed to provide heavy long-range fire support to armored companies, particularly in defensive positions. While not popular with the crews due to its lack of creature comforts and CASE, the Rhino can consistently deliver an impressive amount of ordnance on target and at long range—making it very popular with military strategists and tacticians.

## Capabilities

With two turret-mounted Delta Dagger LRM-20 launchers and a forward-facing Conan DT LRM-10 in the primary hull, the Rhino can deliver up to fifty long-range missiles in a single salvo. Usually, however, tank commanders will split their missiles, with the twin twenty-racks focusing on the main target and the LRM-10

held in reserve to hit any secondary targets—or anything that escapes the first barrage.

While essentially a mobile long-range missile platform, the Rhino can defend itself if attacked directly. Two Starflash medium lasers are mounted on the turret, giving them a three hundred and sixty degree field of fire. They are more than adequate against other armor and pack sufficient punch to give light 'Mechs pause.

The Rhino is slower than many tanks of similar mass with a 54 kph top speed, but is by no means the slowest. Though its armor is adequate against most attacks, the lack of cellular ammunition storage equipment means the four tons of long-range missiles the Rhino carries are vulnerable. The lack of CASE is generally regarded as the design's greatest flaw.

The troopers who crew the Rhino are likely to disagree. There is almost no provision for crew comfort—a point often raised by the tankers who serve aboard Rhinos. It is generally believed that the original designers envisioned the heavy tank remaining in one place for extended periods, with the crews bivouacked elsewhere when not sitting their watch.

## Deployment

Since its introduction, the Rhino has been a standard tank for defensive and long-term armor deployments. It can be found in every military of the Inner Sphere. Periphery nations and worlds lacking extensive BattleMech assets often position platoons of Rhinos to defend cities and DropPorts. However, because of its relatively slow speed and reliance on missiles, the heavy tank is not popular with rapid-strike or recon-in-force units which must be highly mobile and/or spend protracted time away from resupply. The Rhino is rarely found in mercenary units.

## Variants

There are no factory-produced variants of the Rhino. However, as with any design that has been in the field for nearly four centuries, there are a number of common field modifications. None affect the twin LRM-20s and most address the Rhino's lack of short-range

punch—a handicap should its position be overrun. It is common to see the LRM-10 swapped out for a six-tube SRM, with the freed-up space and tonnage going to whatever mix of machine guns or flamers the crew thinks will best defend them against infantry. Though it is possible to mount small lasers with the SRM-6 modification, heat build-up is a problem—one with potentially disastrous consequences given the lack of CASE. It has been confirmed that the First Taurian Armored Lancers field one Rhino with a brace of hull-mounted medium lasers. No technical data is available, but even with all available space devoted to additional heat sinks, this would be a dangerous vehicle to operate.

## Notable Crews

**First Century, Third Maniple:** Though most of the Second Auxilia Loricatus, the armor Legion of the Second Legio Cataphracti, is comprised of Gladius hovertanks, the One-Three is comprised of five aged Rhinos, all in original configuration. Immediately following the Marian Hegemony's annexation of the Lothian League, the Second Legio was stationed on Lordinax and tasked with keeping the peace. Julius O'Reilly, son of Caesar Sean O'Reilly, took command of the Second Legio in the summer of 3060 and immediately set about hunting the Lothian resistance. The One-Three was left to guard the legion's central supply. In hindsight it comes as no surprise that while the bulk of the Second Legio was scattered across the globe, the rebels raided the supply depot in force. Faced with a massed attack meant to overwhelm them through sheer numbers, the One-Three responded with sheer numbers of their own. Gunnery techs worked feverishly under fire to keep the five tanks loaded from stockpiled stores as the tanks fired salvo after salvo. For sixteen hours the tireless One-Three held out against overwhelming odds until Julius O'Reilly and the BattleMech Cohorts arrived to crush the rebel forces.

Type: **Rhino**  
 Technology Base: Inner Sphere  
 Movement Type: Tracked  
 Tonnage: 80  
 Battle Value: 1,463

**Equipment**

		<b>Mass</b>
Internal Structure:		8
Engine:	240	17.5
Type:	Fusion	
Cruising MP:	3	
Flank MP:	5	
Heat Sinks:	10	0
Control Equipment:		4
Lift Equipment:		0
Power Amplifier:		0
Turret:		2.5
Armor Factor:	272	17
<i>Armor Value</i>		
Front	64	
R/L Side	54/54	
Rear	40	
Turret	60	

<b>Weapons and Ammo</b>	<b>Location</b>	<b>Tonnage</b>
LRM 20	Turret	10
LRM 20	Turret	10
Ammo (LRM) 18	Body	3
Medium Laser	Turret	1
Medium Laser	Turret	1
LRM 10	Front	5
Ammo (LRM) 12	Body	1

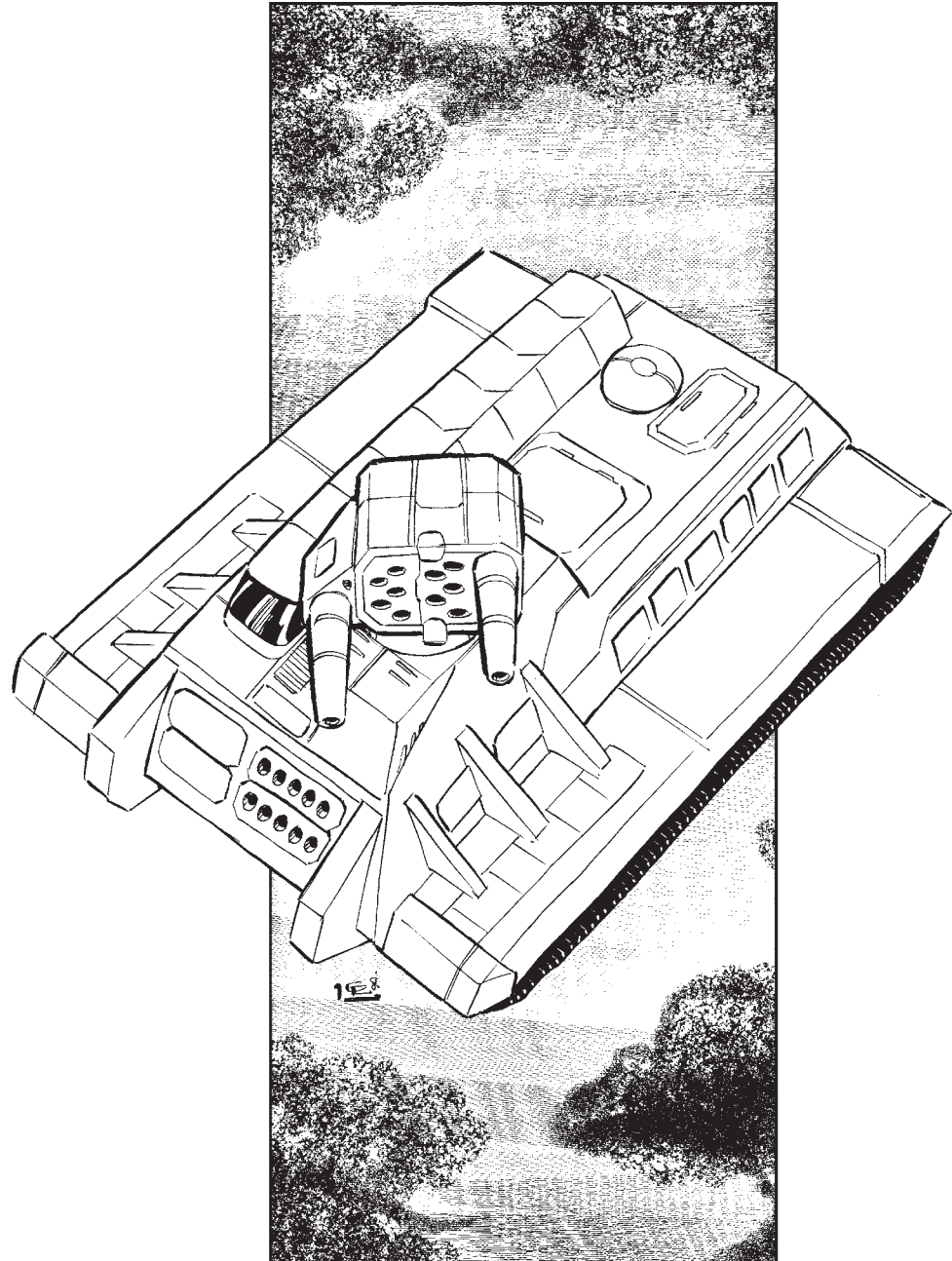

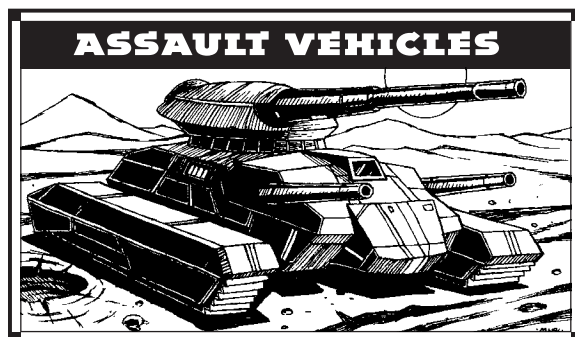

**Mass:** 95 tons

**Movement Type:** Tracked

**Power Plant:** Pitban 285 Fusion

**Cruising Speed:** 32 kph

**Flank Speed:** 54 kph

**Armor:** AmberStar Weave Standard

**Armament:**

2 Holly-20 LRM 20s

1 Donal Technologies PPC

2 Krieger Medium Lasers

1 Holly-4 SRM 4

1 Krieger Small Laser

1 Skylight Model 5 Flamer

**Manufacturer:** Odin Manufacturing, Pandora

'Mech Works

**Primary Factory:** Orestes (Odin),

Terra (Pandora 'Mech Works)

**Communications System:** COMTEC 400E

**Targeting and Tracking System:** GroundTracker EE-4

## Overview

As BattleMech development marched steadily ahead, many began to question the need for a sizeable vehicle research and procurement budget. Indeed, some even were skeptical of the need for combat vehicles at all, with BattleMechs being designed for tasks ranging from reconnaissance to city fighting. A general in the Regular Armored Command caught wind of these doubts and became fearful for his position and his entire department.

The Puma Assault Tank was the response to the encroaching BattleMech regiments. Designed so an

armor lance of Pumas could hold its own against a typical BattleMech lance, the Puma was assigned to armored assault units often utilized in important military operations where the fighting was expected to be fierce.

## Capabilities

The Puma resembles Age of War tanks that once ruled the battlefield before the BattleMech was introduced, and it employs a potent PPC as its main gun. A pair of side-mounted LRM-20s and a frontal SRM-4 rounded out the Puma's versatile armament. An array of lasers and a rear-mounted flamer keep all but the most fanatical infantryman away from the Puma, regardless of whether they are friend or foe.

Eleven and a half tons of standard armor provide enough protection for the most withering fire, though the Star League's attempts at reducing the effect of extreme heat and unlucky hits to the turret and track joints proved to be unsuccessful with the prototype AmberStar MK III mounted on several versions. This armor would re-appear in a workable version on several Clan battle armor designs centuries later.

## Deployment

The Puma, along with several other designs put into production at the same time, revitalized the Star League's armored-vehicle industry. In the original Star League, company and battalion commanders would deploy their Puma lances in a diamond formation, each about a hundred meters apart from each other. The overlapping LRM and PPC coverage gave each unit a strong rally point and an anchor for combat situations and defensive formations.

As upgraded Pumas are being distributed as quickly as possible to the remaining Com Guards and Protectorate militias, many are concentrating them in units surrounded by lighter hovercraft or VTOLs. If the light vehicles find themselves in a situation they can't handle, they will pull back towards the Pumas for a powerful safe haven, often hidden. The subsequent ambush has caught several Davion Lances off guard on New Avalon during the latest round of fighting in the capital city.

## Variants

The Puma is one of the few Star League Era vehicles still produced mostly in its original 005 configuration when both ComStar and Word of Blake restarted production at separate times in 3065. However, both Word of Blake and the remaining Com Guard facilities have taken advantage of recently acquired technology to make the Puma even more effective in the field. The -007 variant is the more common version distributed among Protectorate militias, and it carries a heavier ferro-composite and a light fusion engine. The main PPC is replaced with a heavy version of itself, and all the missile racks are swapped for a trio of large multi-missile racks arranged similarly to the original version. For defense against smaller units, a pair of machine gun arrays and a front-mounted anti-battle armor pod along with CASE protects the costly improved C<sup>3</sup> module inside the 007's chassis.

The less-common 008 was distributed by Word of Blake to a few high ranking Protectorate tank corps officers. It is designed to keep the commander safe at all costs. Three Artemis enhanced multi-missile racks and an extended-range PPC slaved to a targeting computer are the only offensive weapons. To keep the commander out of harm's way, three anti-battle armor pods and an amazing six anti-missile systems dot the hull of this main battle tank. Guardian ECM hides the -008 when it is lying in ambush, and heavy ferro-fibrous tops off the defensive measures.

## Notable Crews

**Lieutenant Reginald Lastrapes:** Operating a 005 Puma for the Epsilon Eridani planetary militia, the young lieutenant was one of the first militia soldiers to reach his machine during a 3069 AFFS raid seeking a Word of Blake supply depot thought to be in Eridani's capital city of Madison. Operated only by himself and a civilian bulldozer driver, Lastrapes's Puma launched raids that lured AFFS forces away from a hospital, shelter and coincidentally, the supply depot. Lastrapes is now one of the foremost Eridanian proponents of the Protectorate, citing the Succession Wars and the two thousand civilian casualties of the 3069 raid as proof that the Houses damage everything they touch.

# PUMA ASSAULT TANK

Type: **Puma Assault Tank**  
 Technology Base: Inner Sphere  
 Movement Type: Tracked  
 Tonnage: 95  
 Battle Value: 1,353

<b>Equipment</b>		<b>Mass</b>
Internal Structure:		9.5
Engine:	285	25
Type:	Fusion	
Cruising MP:	3	
Flank MP:	5	
Heat Sinks:	17	7
Control Equipment:		5
Lift Equipment:		0
Power Amplifier:		0
Turret:		1
Armor Factor:	184	11.5
	<i>Armor Value</i>	
Front	48	
R/L Side	32/32	
Rear	24	
Turret	48	

<b>Weapons and Ammo</b>	<b>Location</b>	<b>Tonnage</b>
LRM 20	Right	10
LRM 20	Left	10
Ammo (LRM) 12	Body	2
PPC	Turret	7
2 Medium Lasers	Front	2
SRM 4	Front	2
Ammo (SRM) 25	Body	1
Flamer (Vehicle)	Rear	.5
Ammo (Flamer) 20	Body	1
Small Laser	Rear	.5

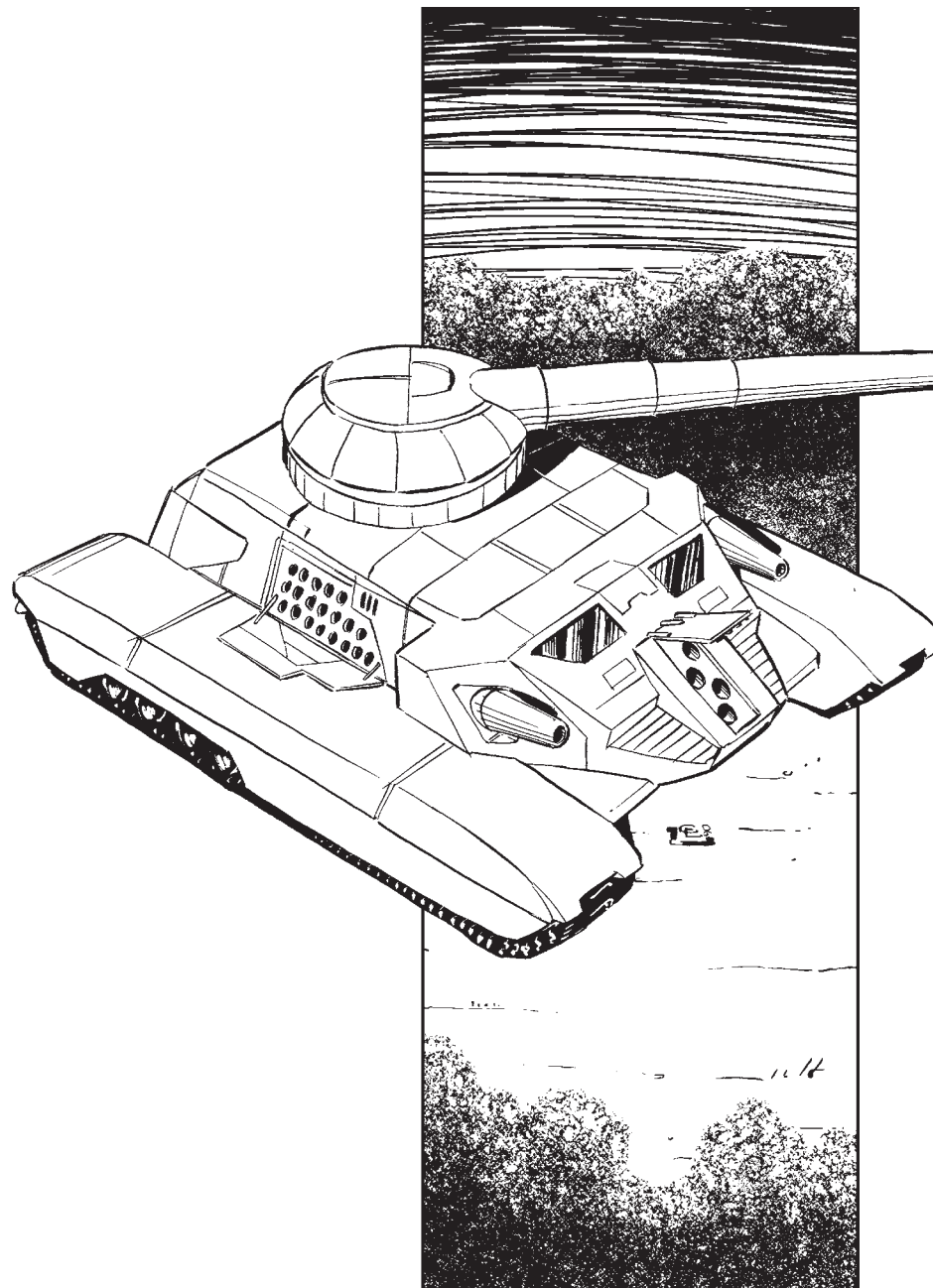

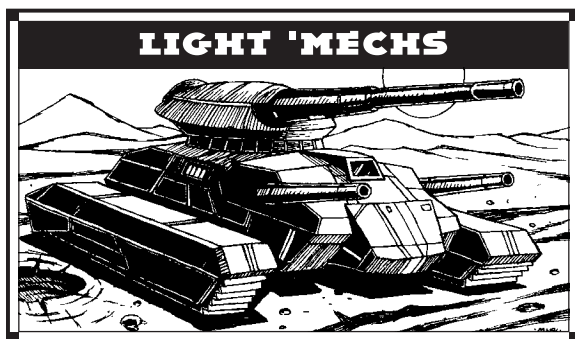

**Mass:** 20 tons  
**Chassis:** Bergan MX II  
**Power Plant:** LTV 160  
**Cruising Speed:** 86 kph  
**Maximum Speed:** 129 kph, 173 kph w/MASC  
**Jump Jets:** None  
**Jump Capacity:** None  
**Armor:** Mitchell-091 Ferro-Fibrous  
**Armament:**  
2 Martell Medium Laser  
2 Hessen IX Small Laser  
**Manufacturer:** Skobel MechWorks  
**Primary Factory:** Russia, Terra  
**Communications System:** DataTech 401  
**Targeting and Tracking System:** Skyhunter IV

## Overview

Many historians credited the *Mercury* with the inspiration of the modern day OmniMech now in use by both the Clans and the Inner Sphere. These beloved BattleMechs disappeared during the vicious Succession Wars. *Mercurys* finally re-appeared during the unveiling of the Com Guards in the mid thirty-first century. Though containing little advanced technology, it was the method of use of the older technology that had historians heaping praise on the light BattleMech.

## Capabilities

Using the most innovative technology at the time, the *Mercury* seemed poised to revolutionize BattleMechs using its pioneering “plug and fight” technology, which streamlined repair and slashed many man-hours from repair and modification work. Workers only need-

ed to take off a few bolts and pull a few wiring connectors to remove damaged equipment, and reverse the process to put in new gear. This cut down bay time to a fraction of what most other designs required.

Taking advantage of the MASC-enhanced speed, the *Mercury* can enter and leave a firefight at the astonishing rate of 172 kilometers per hour. When in combat, the *Mercury* relies on an impressive firepower for its size. A pair of medium lasers backed up by a pair of smaller lasers outgunned many other light 'Mechs, especially those with similar speed. This machine also has the side benefit of being an excellent scout, leading the Com Guards to use the Scout configuration for reconnaissance.

## Deployment

Once the standard reconnaissance light BattleMech of ComStar, attrition whittled it away from the ranks until then-Precentor Martial Focht retooled three of the mothballed production lines on Terra to produce both Models 99 and 97 at the onset of the Clan Invasion. Subsequently, one of these lines was reconfigured to produce the more recent *Nexus* in 3054, and when the Word of Blake took over, they converted another line to produce the *Nexus* and began to replace the older design. However, so many *Mercurys* are in circulation and are easy to repair that nobody believes the design will disappear anytime soon.

## Variants

When ComStar unveiled its Com Guards, they had reconfigured their *Mercurys* to take over scouting for their BattleMech forces. They removed a medium and a small laser to mount Star League-era Beagle Active Probes. This Model 97 was largely discarded after the Battle for Tukayyid as being too light on firepower, even for a scout 'Mech.

In its massive rearmament campaign, Blakists upgraded the *Mercury* line to take advantage of recent advances in technology. Now built around an endo-steel chassis, the Model 102 *Mercury* carries a medium and a small laser, both extended-range. Replacing the Beagle probe with a C<sup>3</sup>i suite, the 102 can also assist in targeting for its comrades.

However, in the last two years, intelligence teams suspect that the remaining *Mercury* line on Terra has been reconfigured to produce the recently spotted Model 104. Similar to the 102 version produced in the last decade, this one seems to carry an additional extended-range medium laser and more armor. Targeting acquisition gear seems to be installed as well, due to the suspiciously high amounts of accurate artillery and orbital support that occurs while the *Mercury* is present. Analysis shows that the only way such a configuration is possible without losing the Blakist preference for C<sup>3</sup>i equipment is mounting an extra-light fusion engine, a modification nearly impossible to perform in the field.

## Notable MechWarriors

**Adept Julie Spartan:** One of the members of the Heart of Blake mercenary unit, Adept Spartan has piloted her model 102 *Mercury* with great skill, foiling Jihadist ambushes attempting to reclaim the unit. However, this has almost led to her death on several occasions, and forced her to take advantage of her BattleMech's ease of repair. Spartan and her techs often revert to Succession Wars habits of scouring battlefields for suitable battlefield salvage to replace damaged components.

**Precentor Terrence Harris:** One of the few Manei Domini that House intelligence agents have been able to put a name too, Precentor Harris is an Omega class on Tharkad. Often alone in his Model 104 nicknamed “Insane God,” Harris acts as an easy target for Lyran defenders to draw them out of hiding. As they attempt to corner him, he calls in a small surgical orbital bombardment from the LCS *Invincible* to annihilate the gathered enemies as he engages his MASC to run out of the kill radius. Archon Peter Steiner has put on a twenty million Kroner reward for the head of Precentor Harris, but it is becoming apparent that not too many are willing to risk their lives for the bounty.



# MCY-99 MERCURY

Type: **Mercury**

Technology Base: Inner Sphere

Tonnage: 20

Battle Value: 531

## Equipment

		<b>Mass</b>
Internal Structure:		2
Engine:	160	6
Walking MP:	8	
Running MP:	12(16)	
Jumping MP:	0	
Heat Sinks:	10	0
Gyro:		2
Cockpit:		3
Armor Factor:	53	3

	<i>Internal Structure</i>	<i>Armor Value</i>
Head	3	5
Center Torso	6	7
Center Torso (rear)		3
R/L Torso	5	6
R/L Torso (rear)		2
R/L Arm	3	5
R/L Leg	4	6

## Weapons and Ammo

	<b>Location</b>	<b>Critical</b>	<b>Tonnage</b>
Medium Laser	RA	1	1
Medium Laser	LT	1	1
Small Laser	H	1	.5
Small Laser	CT	1	.5

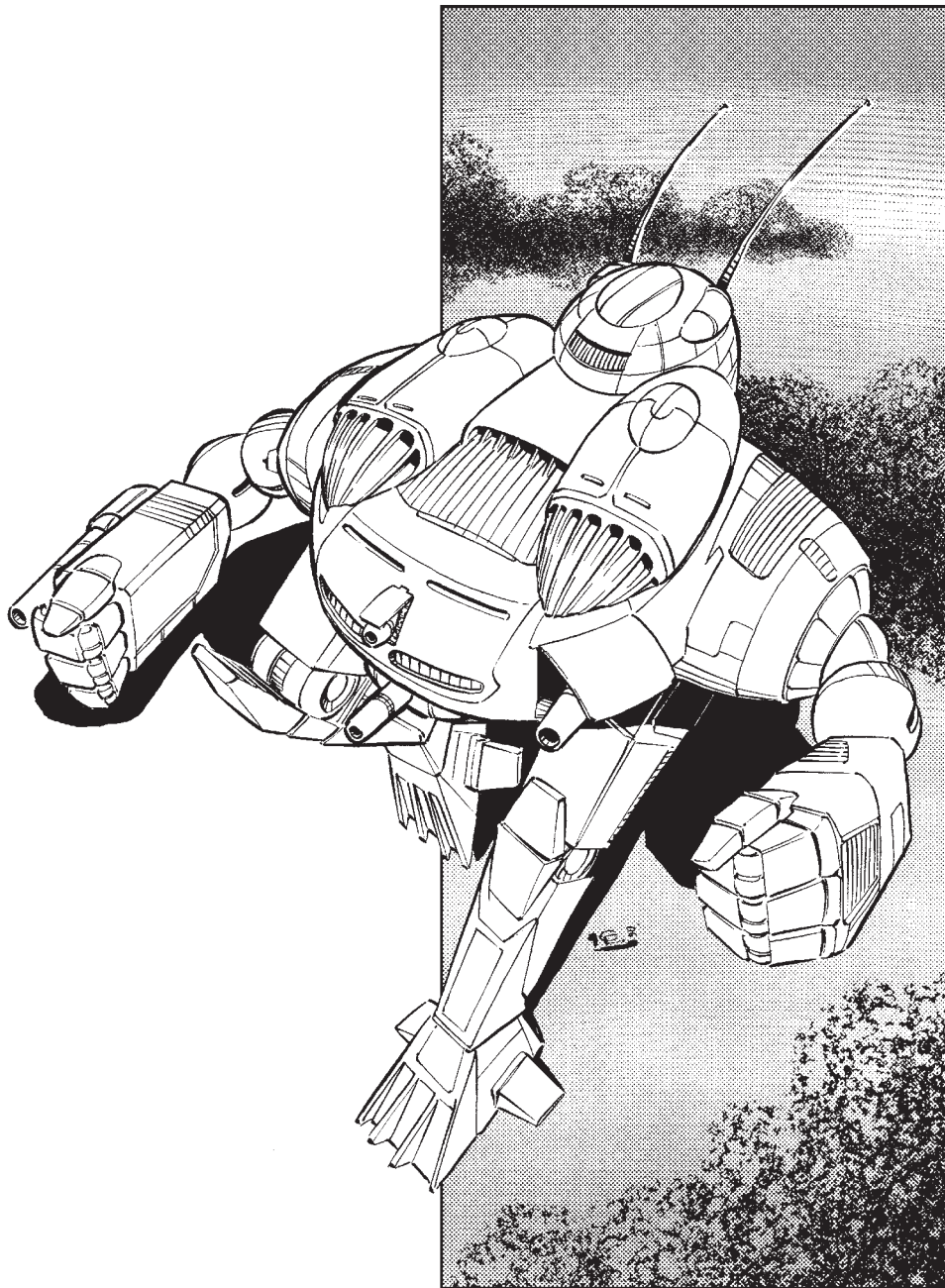

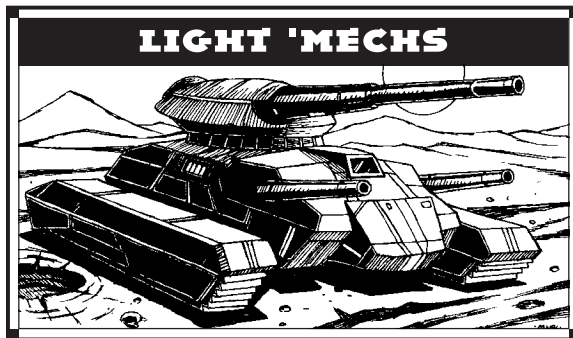

**Mass:** 20 tons  
**Chassis:** Chariot Type II Endo Steel  
**Power Plant:** GM 120  
**Cruising Speed:** 64 kph  
**Maximum Speed:** 97 kph  
**Jump Jets:** None  
**Jump Capacity:** None  
**Armor:** Armorscale with CASE  
**Armament:**  
1 Zeus LRM 5  
2 Hellion Spitfire Medium Lasers  
**Manufacturer:** Ford Military Limited  
**Primary Factory:** Terra  
**Communications System:** Opus I Ultrabeam  
**Targeting and Tracking System:** Orion 80

## Overview

Unveiled in 2490, the original THE-F *Thorn* was soon facing stiff competition from Bergan Industries faster LCT-1V *Locust*. Not to be outdone, Ford Military Limited updated their design with the latest technology, adding endo-steel internal structure and CASE. Since the THE-N *Thorn* was one of the first BattleMechs to use these new construction materials, its arrival of the THE-N *Thorn* in 2549 was accompanied by tremendous hype. As Ford had hoped, the HAF placed large orders for the *Thorn*, and the 'Mech continued to play a prominent role in the ranks of the SLDF.

## Capabilities

Well armed and armored, the *Thorn* could match many 'Mechs in its weight class in a toe-to-toe slugfest. The Hellion Spitfire medium lasers are efficient

and powerful, although the placement of one directly under the cockpit can make battle uncomfortable for the MechWarrior. The Zeus missile system provides accurate long-range firepower, but it is easily damaged in hand-to-hand combat. In such circumstances the missile-feed system can fail, causing missiles to become lodged in the upper arm. Subsequent damage can detonate the ammunition, blowing the arm off.

Ease of maintenance has earned the design high marks from technicians. Service crews can climb into the 'Mech's arms and legs alongside the myomer bundles and work on repairs from the inside.

## Deployment

Lacking jump jets, the *Thorn* is ill-suited to scout duty. Instead the SLDF usually employed the 'Mech as a scout hunter or assigned it to serve alongside 'Mechs like the *Hoplite* to support armor or infantry.

The *Thorn* fared badly during the Succession Wars, and as the ability to repair the sophisticated endo-steel chassis was lost, the upgraded version had all but vanished from the battlefield. The Successor States continued sporadic production of the older THE-F, but pressing need for light scout units often took precedence.

When ComStar seized control of Terra at the start of the Succession Wars it inherited a cache of Star League equipment. Used later to arm the Com Guards, this goldmine of lostech included the THE-N *Thorn*. Many of these retrofitted 'Mechs ended up in the ranks of the Ghost regiments. Now in control of Terra, the Word of Blake has been manufacturing new *Thorns* as part of their drive to build up the Word of Blake Protectorate Militia.

With their SLDF origins, the Clans also possess the *Thorn* in relatively large numbers. Half forgotten in their Brian Caches, these 'Mechs are occasionally reactivated to serve in solahma units.

## Variants

The old THE-F was used as the blueprint for the THE-S refit that ComStar provided to the Draconis Combine during the run up to the War of '39. Lacking CASE and endo-steel internal structure, the THE-S also carries half a ton less armor.

With the Clans slicing into the Inner Sphere at the beginning of the 3050s, Precentor Martial Anastasias Focht ordered a crash rearmament program to prepare the Com Guards for the possibility that they would one day have to face the technologically advanced invaders. Produced as a factory refit, the THE-N1 employs an XL power plant to free up space for new suite of weapons. A Kinslaughter H-class extended-range PPC replaces the LRM system, and one medium laser is removed while the other head-mounted laser is replaced with an Intek small laser. Double heat sinks are used to deal with the heat generated by the particle weapon.

The THE-N2 has just entered service with the Word of Blake. Like the THE-N1, this version uses an XL power plant. Instead of a PPC, it is armed with a new multi-missile launcher system. With a CASE-protected magazine and a two-ton capacity, the flexibility of the MML 7 can be exploited well. Like the N1, the only other weapon carried is a small laser—and Diverse Optics extended-range model in this case.

## Notable MechWarriors

**Adept Kevin Ziwiki:** Joining ComStar after the Com Guard's epic battle against the Clans on Tukayyid, Ziwiki was selected for MechWarrior training. Demonstrating a flair for light 'Mech operations, he was assigned to the Thirty-first Division and performed with distinction against the Smoke Jaguars.

With the dissolution of the Star League, this once-idealistic young man has had to watch as the Com Guards disintegrated around him. For Ziwiki the final straw was the revelation that Primus Shari-lar Mori was actually a Combine agent. Taking his 'Mech with him, he broke from ComStar, and now he acts as an independent mercenary, scratching out a marginal existence.

# THE-N THORN

Type: **Thorn**

Technology Base: Inner Sphere

Tonnage: 20

Battle Value: 546

## Equipment

		Mass
Internal Structure:	Endo Steel	1
Engine:	120	4
Walking MP:	6	
Running MP:	9	
Jumping MP:	0	
Heat Sinks:	10	0
Gyro:		2
Cockpit:		3
Armor Factor:	69	4.5

	Internal Structure	Armor Value
Head	3	9
Center Torso	6	8
Center Torso (rear)		4
R/L Torso	5	6
R/L Torso (rear)		4
R/L Arm	3	6
R/L Leg	4	8

## Weapons and Ammo

	Location	Critical	Tonnage
LRM 5	RA	1	2
Ammo (LRM) 24	RT	1	1
CASE	RT	1	.5
Medium Laser	H	1	1
Medium Laser	LA	1	1

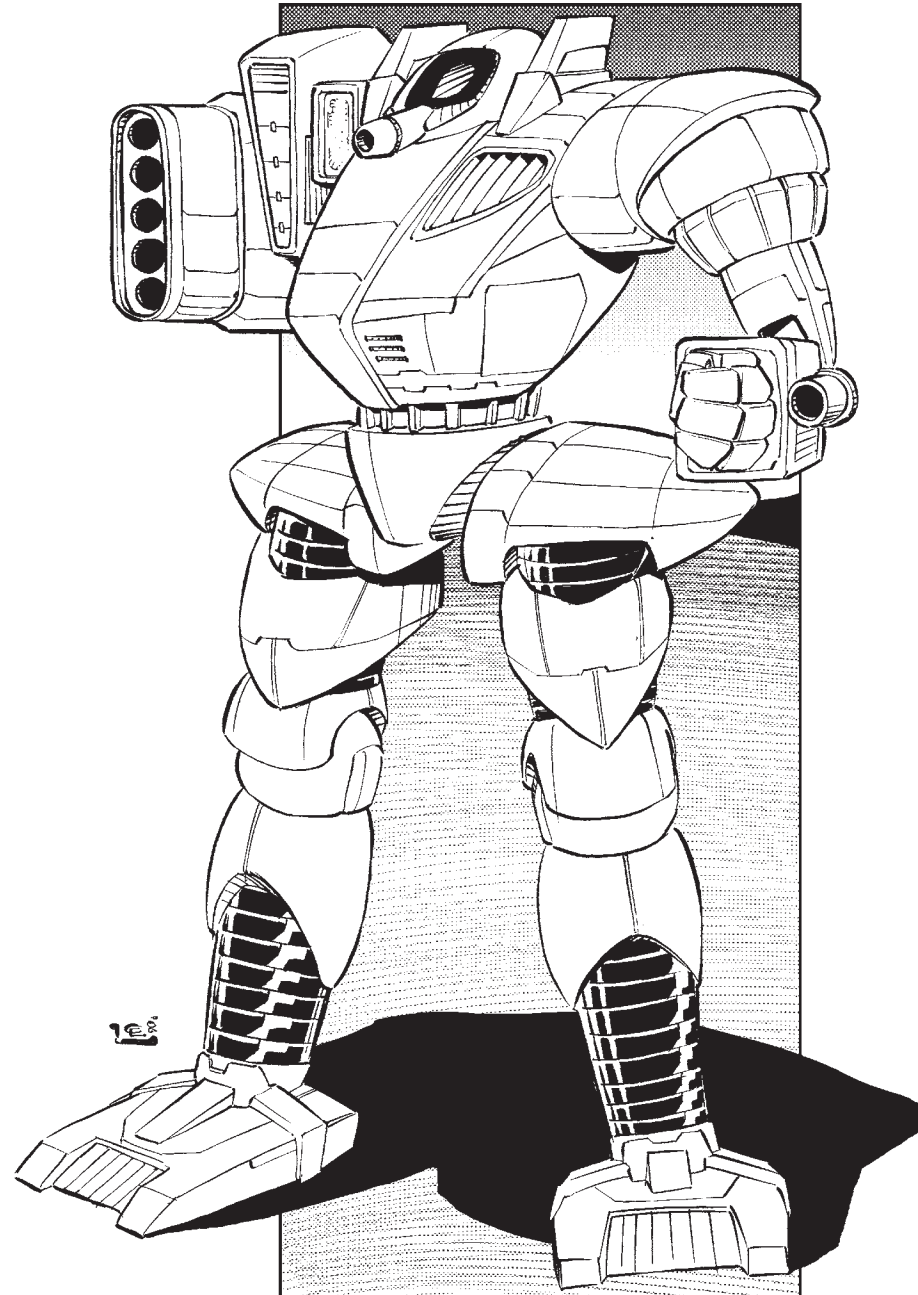

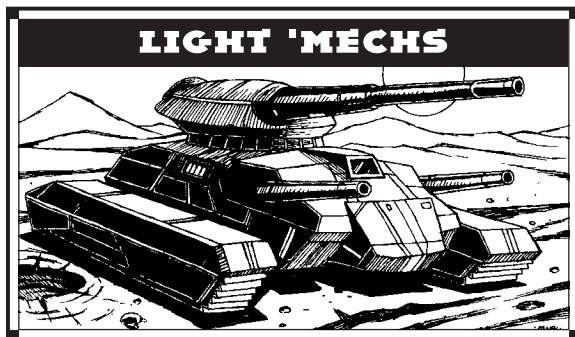

**Mass:** 25 tons

**Chassis:** Kell/D Endo Steel

**Power Plant:** Nissan 200

**Cruising Speed:** 86 kph

**Maximum Speed:** 129 kph

**Jump Jets:** None

**Jump Capacity:** None

**Armor:** Mitchell GA3 Ferro-Fibrous

**Armament:**

3 Sorenstein Medium Lasers

1 Starflash Plus Small Laser

**Manufacturer:** Diplan 'Mechyards of Ozawa

**Primary Factory:** Ozawa (destroyed 2837)

**Communications System:** ON-5

**Targeting and Tracking System:** ON-6 with  
Beagle Active Probe

## Overview

The *Mongoose* was introduced in 2660 as a deep recon 'Mech. However, it soon became a favorite of commanders due to its Beagle Active Probe. Not only do the Beagle's sensors penetrate most interference, but its data storage system retains detailed information on all targets, including analyses of combat tactics employed. This enables quick recognition of any enemy 'Mechs or MechWarriors encountered before. It also allows commanders to evaluate an opponent's capabilities and to test countermeasures in simulation.

Unfortunately, the probe was one of the casualties of the Succession Wars, and no active *Mongoose* is believed to have carried one after the onset of the Third Succession War. Recovery of lostech has made the

Beagle available, however, and currently a *Mongoose* without a probe is almost unheard of.

## Capabilities

Because the *Mongoose's* intended missions would require stealth as well as speed, Diplan went against conventional thinking and did not include jump jets in their design. Their theory—obvious in retrospect—was that you can't hide a BattleMech in the air. Diplan employed a Nissan 200 reactor—large for this weight class—to make the *Mongoose* one of the fastest BattleMechs on the ground.

Because Diplan designers realized a scout 'Mech would usually have to fight alone, the *Mongoose* carries a heavy load of armor, capable of withstanding a PPC blast at close range, and it is armed with four lasers—three mediums and a small. It's a foolhardy MechWarrior that pits a light 'Mech against a *Mongoose* in single combat, and pilots of many medium BattleMechs think twice before tackling the feisty scout one on one.

The *Mongoose* employs primary cooling collars mounted just above the elbows to efficiently dissipate heat from the two arm-mounted weapons. However, the cooling jacket for the laser in the center torso rests directly atop the engine housing and is subject to rapid deterioration. Replacement is recommended after every 100 firings. Jacket failure does not inhibit weapon use, but it makes the cockpit uncomfortable and can interfere with the active probe.

Particularly noteworthy are the internal compensators utilized by the medium laser mounted in the center torso and the small laser mounted just below the 'Mech's cockpit. These compensators allow the two centerline lasers to be fired with uncanny accuracy even when the *Mongoose* is at a full run over broken terrain.

## Deployment

The *Mongoose* is a rare BattleMech, and one highly valued by commanders throughout the Inner Sphere. Examples have been observed in all of the major armed forces, several Periphery realms and in mercenary commands ranging from the most prestigious to the most questionable.

## Variants

Two variants of the *Mongoose* date from the decades when replacements for the Beagle Active Probe were unavailable. One mounts a short-range missile rack in place of the probe. The second adds a set of flamers to each arm and removes the small laser.

## Notable MechWarriors

**Adrianna Chowla:** When elements of the Second Battalion of the First Marik Militia were surrounded by the Sixth Defenders of Andurien in the city of Baroda, Staff Sergeant Adrianna Chowla found herself the sole survivor of her recon lance and behind enemy lines. Anticipating the First Marik would mount a rescue without her running back to sound the alarm, Chowla chose not to withdraw. Her unorthodox decision proved wise when the First Defenders of Andurien arrived to augment the Sixth. Remaining dangerously close to Andurien forces, she conducted a thorough evaluation not only of the two units' assets, but of the First Defenders' preparations to meet the Marik Militia's thrust. Several times in the opening days of what proved to be the pivotal battle of the Andurien campaign, Chowla made her way clear of the Defenders' positions to broadcast her information to the First Marik. The Defenders were not oblivious to Chowla's presence—the "Ghost 'Mech," as they called her, was sighted and fired on several times. Nor did Chowla evade every pursuer. The battle ROM recording of her *Mongoose's* improbable victory over a *Vindicator-1R* is still part of the light 'Mech dueling module at the Allison MechWarrior Institute. This fire-fight damaged the cooling jacket on the torso-mounted laser. Realizing the data she collected was more important than her own safety, Chowla deliberately disabled the medium laser to keep its waste heat from fogging the Beagle Active Probe's sensor array. Colonel Shanna del Ray cited Sergeant Chowla's reconnaissance as the vital key to the First Marik Militia's victory over the larger Andurien force.

# MON-66 MONGOOSE

Type: **Mongoose**

Technology Base: Inner Sphere

Tonnage: 25

Battle Value: 763

## Equipment

		Mass
Internal Structure:	Endo Steel	1.5
Engine:	200	8.5
Walking MP:	8	
Running MP:	12	
Jumping MP:	0	
Heat Sinks:	10	0
Gyro:		2
Cockpit:		3
Armor Factor:	89	5

	Internal Structure	Armor Value
Head	3	9
Center Torso	8	12
Center Torso (rear)		4
R/L Torso	6	10
R/L Torso (rear)		2
R/L Arm	4	8
R/L Leg	6	12

## Weapons

Weapons and Ammo	Location	Critical	Tonnage
Medium Laser	RA	1	1
Medium Laser	LA	1	1
Medium Laser	CT	1	1
Small Laser	H	1	.5
Beagle Active Probe	LT	2	1.5

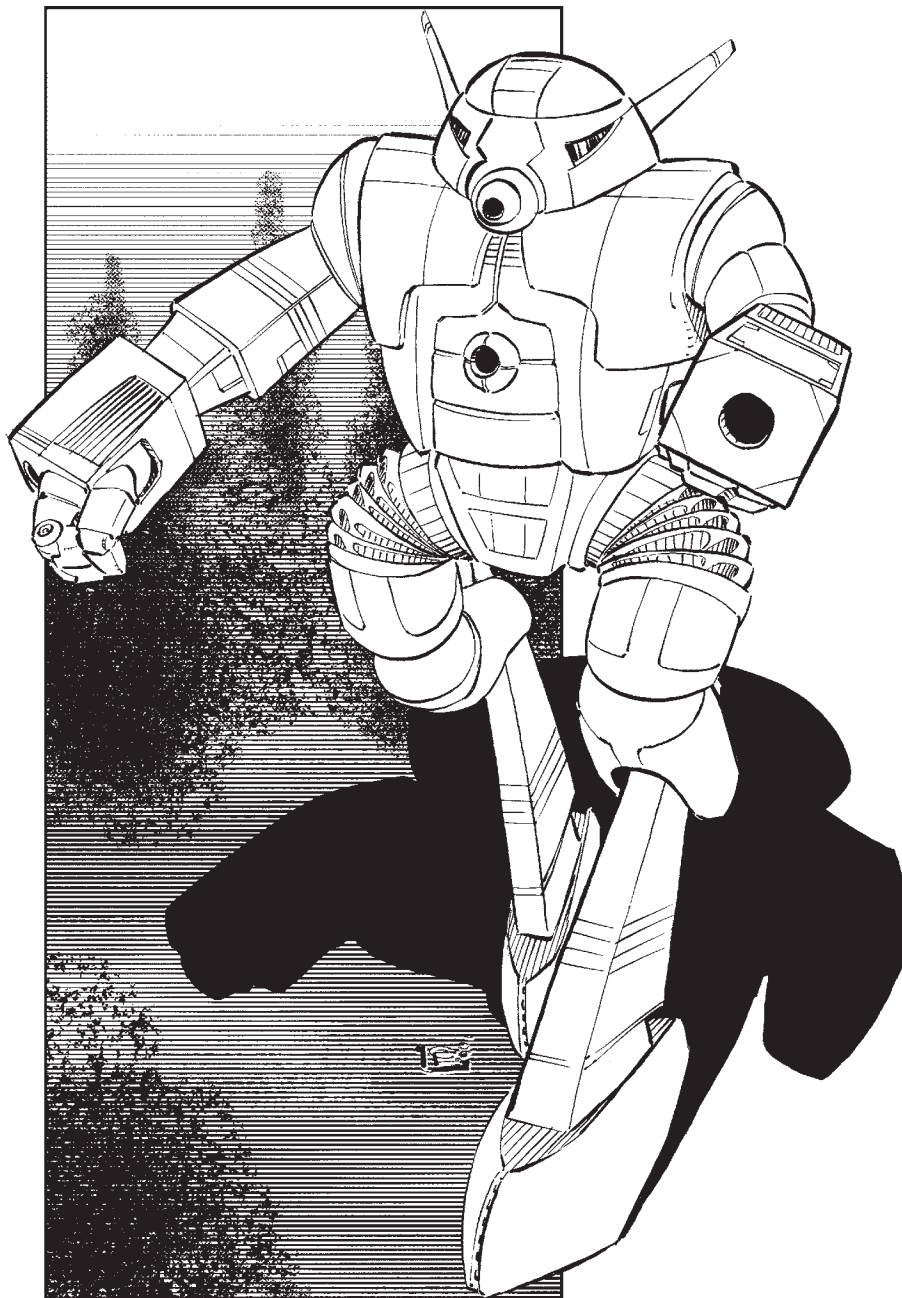

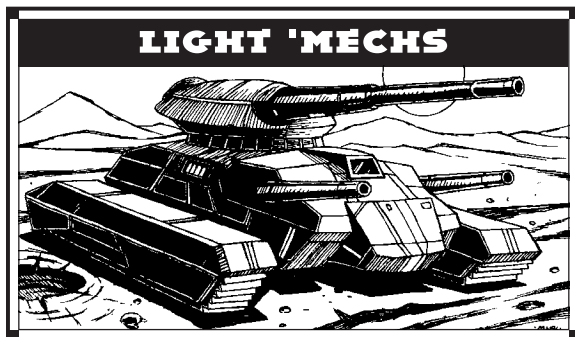

**Mass:** 30 tons

**Chassis:** Irian Chassis Class 10

**Power Plant:** GM 270

**Cruising Speed:** 97 kph

**Maximum Speed:** 151 kph, 194 kph w/MASC

**Jump Jets:** None

**Jump Capacity:** None

**Armor:** Jolassa-328 Ferro Fibrous

**Armament:**

2 Hellion-V Medium Lasers

**Manufacturer:** Irian BattleMechs Unlimited

**Primary Factory:** Irian

**Communications System:** Irian Telestar

**Targeting and Tracking System:** Alexis Photon Target Acquisition System with Beagle Active Probe

## Overview

The *Hermes* was first fielded by the Star League Defense Force in the 27th century, where it served as a reconnaissance 'Mech until General Kerensky's Exodus. The design slipped out of production before the Fall of the Star League, languishing in Irian BattleMechs Unlimited's computer banks for centuries until the level of technology had increased to the point where it could be built once again.

As the company still possessed the complete technical plans for the 'Mech, Irian chose the *Hermes* as its first technology demonstrator in 3043. It took their engineers an additional four years to work out production issues with the new construction materials they were using, however. By that time, they had further modified the *Hermes*, making it a far superior scout 'Mech.

## Capabilities

Speed has always been the *Hermes*' greatest asset, but even during the Star League era it was not enough to make up for its paltry two and a half tons of ferro-fibrous armor—less than half of the theoretical maximum its chassis can mount. Irian's designers considered correcting that while preparing the design for production, but in the end they concentrated on enhancing the 'Mech's strengths.

This new *Hermes* makes use of MASC, giving its MechWarriors a temporary thirty percent speed boost that they can use to get out of trouble. It also now mounts a Beagle Active Probe tied directly to its outstanding Alexis Photon targeting and tracking system, and the combination makes the *Hermes* a truly outstanding recon unit. That it only carries two medium lasers is meant as much to stave off pursuit as to discourage MechWarriors from engaging in unsupported combat.

## Deployment

Irian's new *Hermes* was distributed throughout the FWLM, filling critical holes in scout lance formations left by the rapidly dwindling number of capable recon platforms, such as the *Ostscout*. Production tapered off after a few years as Irian shifted assembly to construction of other upgraded designs, though the *Hermes* has remained in constant production on at least one line since its reintroduction.

After the Clan Invasion, the Free Worlds League government allowed Irian to sell its wares to the Draconis Combine and the Federated Commonwealth, though "bureaucratic snafus" and "contract issues" prevented a single *Hermes* from ever making its way to either of those nations for a full decade. That ensured the League had exclusive use of the 'Mech during Operation Guererro, when several *Hermes* were used on half a dozen worlds to scout out enemy positions before the bulk of the invasion forces arrived.

## Variants

In 3049, Irian began limited production on two variant models, one that exchanged the Beagle active probe for a Guardian ECM suite—the 3S1—and the second that retained the ECM and replaces one of the

two medium lasers with a TAG unit—the 3S2. It was nearly a decade before the next major variants of the *Hermes* appeared. Based on the first variant, the 4S incorporates an XL engine and swaps the two medium lasers for three pulse versions and three much-needed tons of armor. The next two are variations on the same theme. The 4K is produced for export to the Combine, mounting a C<sup>3</sup> module and an array of six medium and one small ER lasers; the similar 4M carries instead a C<sup>3</sup>i system, dropping a medium and small laser to make room for it.

There are rumors of a Blakist-fielded version, making use of stealth armor. If it exists, the Word of Blake is closely guarding it, employing it to scout out potential targets for annihilation.

## Notable MechWarriors

**Acolyte V Harmis Ichimoto:** Acolyte Ichimoto joined at the height of the FedCom Civil War. Assigned to the ill-fated Sixty-sixth Division in mid-3066, Ichimoto spent the nearly year-long campaign for the world detached as part of a special reconnaissance force that kept tabs on Peter Steiner-Davion's advance across Tharkad. He was captured in the final weeks of the battle, but released shortly after the end of the war. Nine months later, he was on Tharkad's front lines again, this time battling the Word of Blake alongside the 66th's few surviving demi-companies.

**Lieutenant (senior grade) Beata Gulipous:** Thrown into Marshal Jeremy Brett's unsanctioned rescue of Kristen's Krushers in 3063, Lieutenant Gulipous was part of the five two-'Mech recon elements that scouted out the Second Donegal Guards' positions on Arcadia. She found the break in the Donegal Guards' line that allowed the Sixth Marik Militia to break through and rescue the Krushers.

# HER-3S HERMES

Type: **Hermes**

Technology Base: Inner Sphere

Tonnage: 30

Battle Value: 606

## Equipment

		Mass
Internal Structure:	Endo Steel	1.5
Engine:	270	14.5
Walking MP:	9	
Running MP:	14 (18)	
Jumping MP:	0	
Heat Sinks:	10	0
Gyro:		3
Cockpit:		3
Armor Factor:	44	2.5

	Internal Structure	Armor Value
Head	3	4
Center Torso	10	6
Center Torso (rear)		2
R/L Torso	7	6
R/L Torso (rear)		2
R/L Arm	5	4
R/L Leg	7	4

## Weapons

And Ammo	Location	Critical	Tonnage
Medium Laser	RA	1	1
Medium Laser	LA	1	1
Beagle Active Probe	RT	2	1.5
MASC	LT	2	2

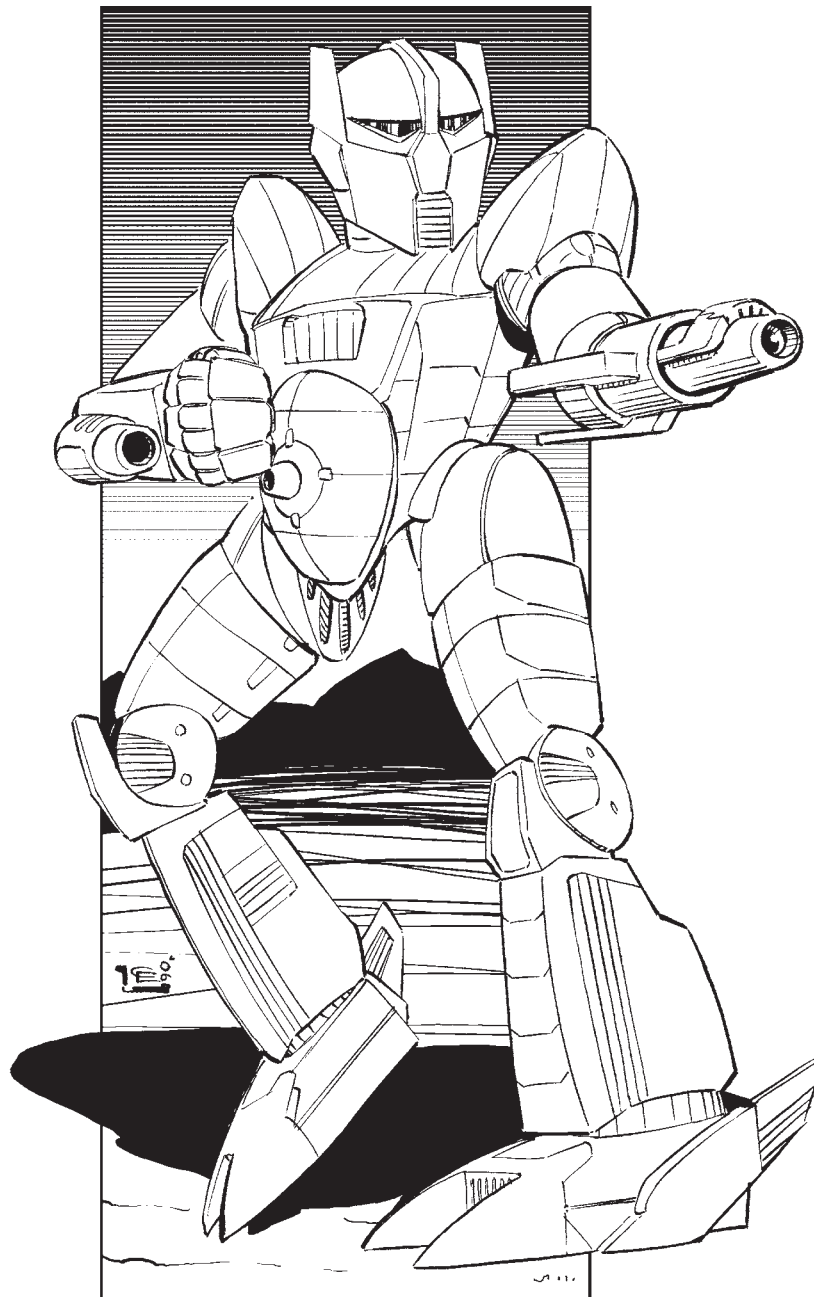

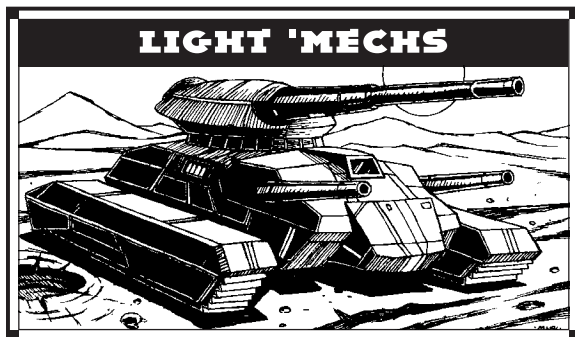

**Mass:** 30 tons

**Chassis:** Benztrov 40

**Power Plant:** GM 270

**Cruising Speed:** 97 kph

**Maximum Speed:** 151 kph

**Jump Jets:** None

**Jump Capacity:** None

**Armor:** Lexington Limited High Grade Ferro-Fibrous

**Armament:**

1 Newhart Extended-Range Large Laser

**Manufacturer:** Coventry Metal Works

**Primary Factory:** Coventry

**Communications System:** Field Ranger Sightseer

**Targeting and Tracking System:** Ranger LAF Model 2

## Overview

Considered the most common reconnaissance platforms in the Star League Defense Force, the HSR-200-D series could achieve top speeds cresting 150 kph. Because of this, *Hussars* were notoriously difficult to target and engage in straight-up battles. Though more modern designs have become equally capable scouts, the *Hussar* remains the textbook example of a light recon BattleMech.

Because the original SLDF used a large number of the *Hussar* in its light 'Mech formations, very few of the design existed among the Great Houses. Thus, when General Kerensky's Exodus removed the bulk of the SLDF army from the Inner Sphere, scant few of the design remained behind. Subsequently, the *Hussar* became a lost design until unveiled by the Com Guards in 3051. When ComStar opened its archives after the Schism in 3052, Coventry Metal Works quietly

bought the rights to the *Hussar* design from Bonn Mekarmorwerks, who were developing the 400-D series for the Com Guards. The Lyran arms company produced several new variants for the AFFC/LAAF between 3055 and 3068. Shipments ceased when the Word of Blake assaulted Coventry during the opening salvos of the Jihad.

## Capabilities

Woefully under armored when compared to other recon designs, the *Hussar* is not meant for one-on-one fighting. Though the original design mounts an extended-range large laser, allowing it to snipe from outside most light 'Mechs' weapon ranges, the MechWarrior must remember his primary advantage is speed. Unfortunately, because many inexperienced Lyran pilots enjoy stand-up fights (due to training in heavier designs), the pilot mortality rate in a *Hussar* is excessively high.

Equipped with superior communications and surveillance gear (ComStar allowed CMW to copy the original Field Ranger Sightseer schematics in 3055), *Hussars* were invaluable to many LAAF commanders during the FedCom Civil War. Towards the end of the conflict, it became standard procedure to drop at least a lance of *Hussars* in the enemy's rear area with orders to scout and cause havoc along the main supply lines. Not a new tactic, it seems that several hard-line Lyran commanders are copying Kerensky's older SLDF tactical operation maneuvers when it comes to deploying *Hussars*.

## Deployment

Predominately found among Lyran frontline regiments, *Hussars* form the backbone of scout and reconnaissance units. These units seem to work well in conjunction with the *Osiris* and *Stillette* BattleMechs, though they rarely see much combat due to their delicate nature.

## Variants

By far the most common variant seen on today's battlefield, the HSR-200-D is equipped with a single ER large laser but only carries one and a half tons of armor across its nimble frame. The far more rare 300-D was a stripped-down design provided to the Draconis Com-

bine by ComStar during the 3030s as part of their secret re-arming deal with then-*Kanrei* Theodore Kurita.

ComStar attempted to improve the original design by installing a GM-240 XL engine, allowing enough torso room to mount a heavier LB 10-X autocannon for more close-in combat. The extra space also allowed ComStar engineers to double the design's armor. CMW manufactured both the 200-D and 400-D series on Coventry through the civil war.

Bonn Mekarmorwerks produced the 600-D variant sporting C<sup>3</sup>i technology and an ER PPC in 3060, which has only been seen among Word of Blake militia forces.

A newer variant was unveiled in mid-3067, mounting a light autocannon. Christened the 900-D series, it was never produced beyond the prototype stage before the Word of Blake seized the CMW complex. Recent Loki reports indicate that both this variant and a newer one have been seen coming from CMW's assembly point. Both variants mount heavy ferro-fibrous armor, with the Blakist version sporting what appears to be a snub-nose PPC and paired ER medium lasers.

## Notable MechWarriors

**Major Joseph Norton:** Commander of a small unit composed of ten *Hussars* attached to the Fifty-first Hussar Regiment of the SLDF's XXX Corps in the twenty-seventh century—also known as "The Fingers of Death"—he has been credited with proving the *Hussar* design a "positive combat asset." Skilled in maneuvering well behind enemy lines, he would orchestrate strikes on several key support elements, destroying communication arrays, ammunition stores, and even killing commanders who believed they were safe in the rear-most areas.

After his retirement in 2642, he published a small book on his vision of scout and reconnaissance warfare (*The Strategy of Support*); the book went unnoticed for centuries until the Alarion Historic Foundation discovered an electronic copy in 3059. Even though it is now a required text at the Nagelring, sales of the book inside the Alliance remain less than those in the FRR.



# HSR-200-D HUSSAR

Type: **Hussar**

Technology Base: Inner Sphere

Tonnage: 30

Battle Value: 636

## Equipment

		<b>Mass</b>
Internal Structure:		3
Engine:	270	14.5
Walking MP:	9	
Running MP:	14	
Jumping MP:	0	
Heat Sinks:	10 [20]	0
Gyro:		3
Cockpit:		3
Armor Factor:	26	1.5

	<i>Internal Structure</i>	<i>Armor Value</i>
Head	3	3
Center Torso	10	3
Center Torso (rear)		2
R/L Torso	7	3
R/L Torso (rear)		2
R/L Arm	5	2
R/L Leg	7	2

## Weapons

### and Ammo

	<b>Location</b>	<b>Critical</b>	<b>Tonnage</b>
ER Large Laser	CT	2	5

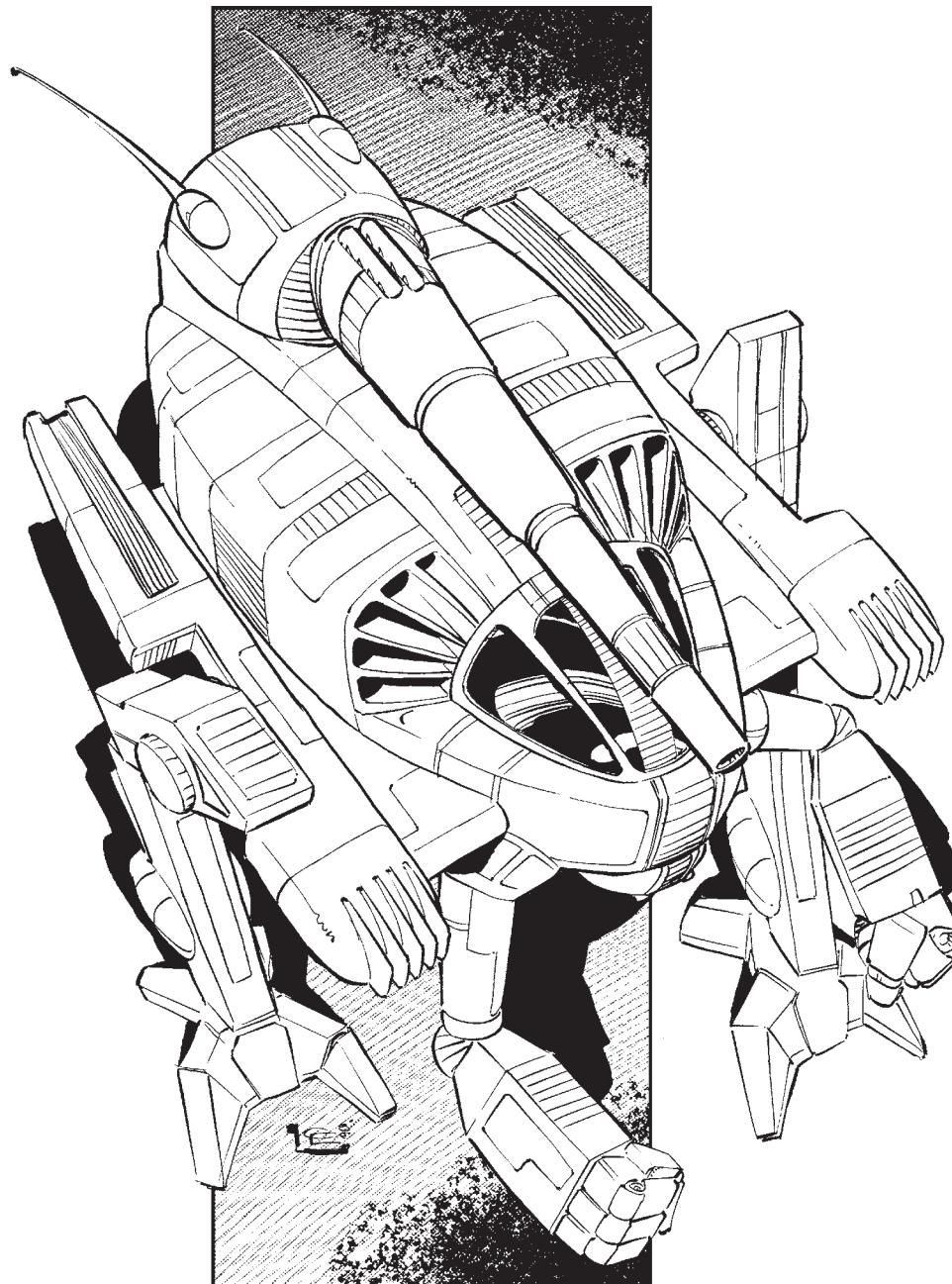

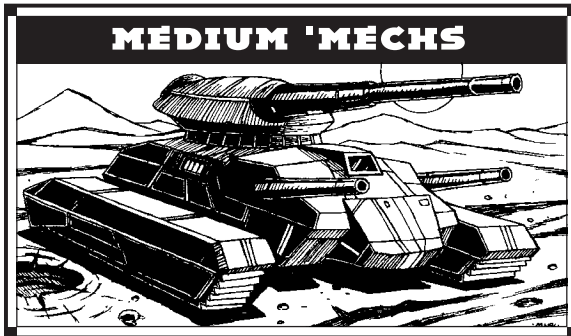

**Mass:** 40 tons

**Chassis:** Defiant V

**Power Plant:** Pitban 240

**Cruising Speed:** 64 kph

**Maximum Speed:** 97 kph

**Jump Jets:** None

**Jump Capacity:** None

**Armor:** Valiant Lamellor

**Armament:**

1 KWI AC/5 Ultra Autocannon

1 Defiance B-1A Small Laser

1 Defiance Streak-2 SRM Launcher

**Manufacturer:** Defiance Industries

**Primary Factory:** Hesperus II

**Communications System:** StarLink/Benicia  
Model AS829G

**Targeting and Tracking System:** Targa-7,  
Vid-Com-17

## Overview

Defiance Industries—at the time a largely Terran-owned corporation operating on Lyran soil—first began to produce the *Sentinel* BattleMech for the Steiner family in 2651 under an exclusive contract. Though Terran Hegemony politicians initially took umbrage with the Steiners buying 'Mechs directly from Hegemony facilities, Lyran diplomats asserted that their deal with Defiance was perfectly legitimate and mutually beneficial to both Star League realms at the economic level.

When a League Council amendment the following year permitted the expansion of House armies and opened up the sale of *Sentinels* to the SLDF itself, however, the League military invested heavily in upgraded

versions of the Steiners' "exclusive design." That these upgraded SLDF *Sentinels* were slow to reach the LCAF buyers (due to contractual stipulations stemming from their original deal with Defiance) was not lost on the Steiner family.

## Capabilities

On the light end of the medium-weight class, the Star League's STN-3L boasted armor and speed roughly identical to that of the Steiners' STN-1S model. With a top speed near 100 kilometers per hour and enough protection to weather the type of firepower carried by most infantry and APC units, the Sentinel was well suited to infantry fire support. In addition, it carried an upgraded Kawabata Weapons Industries "Ultra" Autocannon that nearly doubled the rate and volume of fire the Steiner variant's Defiance Killer Model F (now out of production), along with an enhanced Streak SRM launch system, in place of the less accurate Coventry Quad-Rack. Only the use of the Defiance A-1 small laser matched the payload of the original 1S, but due to lens cracking issues during extended operations, both the SLDF and the Steiner variants phased out the A-1 lasers in favor of the more reliable B-1A series by 2678.

## Deployment

Although the Lyrans would spend the better part of two years working to gain access to the upgraded weaponry kits needed to bring their *Sentinels* to the STN-3L standard, Defiance continued to offer the 'Mech primarily to the Hegemony, all but stifling their original customer as part of an economic lesson to the Lyran government. The LCAF would have the last laugh, however, after the fall of the Star League, when Defiance and all its factory lines became part of the Federation of Skye and not only the *Sentinel*, but all Defiance lines would become part of the Steiner military. The ravages of the early Succession Wars and changing LCAF procurement priorities ("big 'Mechs") dwindled *Sentinel* numbers to nearly nothing until the technological recovery of the 3030s made it possible for Defiance to reintroduce the Star League design in the mid-3050s.

## Variants

Even before its tech recovery, Defiance fielded a downgraded 3K model *Sentinel* in limited numbers. However, these low-tech variants—which carried a standard SRM-2 and autocannon with a two-ton magazine—could not match the ComStar-provided *Sentinels* that the DCMS deployed in the War of 3039. Even though their STN-3Ms used a standard Canopian-produced Marklin SRM-2 in place of the 3L's Streak system, their combination of a medium laser and original KWI Ultra kept them well ahead of their downgraded Steiner counterparts.

More recently introduced variants emerged in the 3060s, with the FedSuns' radical STN-4D model using endo-steel, ferro-fibrous armor, and double heat sinks to revamp its armor levels while replacing its arsenal with a Rotary AC/5 and an ER medium laser. Meanwhile, the Combine STN-C variant simply took the 3M model and traded in its medium laser for a C<sup>3</sup> slave unit.

The newest STN variant, however, only recently emerged from the Blakist-controlled Defiance factory lines. Sporting a light fusion engine and double heat sinks, the STN-5WB packs remarkable firepower with a pair of light AC/5s on its left arm, backed up a trio of ER medium lasers spread across the torso, and even saves enough mass for an overall armor upgrade.

## Notable MechWarriors

**Penelope Farheim:** Piloting a captured BattleMech, Farheim was a test pilot for Defiance Industries when Hesperus II fell to the Word of Blake. She found herself suddenly called upon as a scout for the Hesperan resistance, a ragtag collection of surviving elements of the factory's security corps and scattered LAAF units. Claiming her STN-5WB at the cost of a battered *Stiletto* proved to be the high point of her career to date, but already a lack of adequate munitions and spare parts is threatening to sideline both Farheim and her prize.

# STN-3L SENTINEL

Type: **Sentinel**

Technology Base: Inner Sphere

Tonnage: 40

Battle Value: 717

## Equipment

		Mass
Internal Structure:		4
Engine:	240	11.5
Walking MP:	6	
Running MP:	9	
Jumping MP:	0	
Heat Sinks:	10	0
Gyro:		3
Cockpit:		3
Armor Factor:	88	5.5

	Internal Structure	Armor Value
Head	3	9
Center Torso	12	10
Center Torso (rear)		7
R/L Torso	10	8
R/L Torso (rear)		5
R/L Arm	6	8
R/L Leg	10	10

## Weapons and Ammo

	Location	Critical	Tonnage
Ultra AC/5	LA	5	9
Ammo (Ultra) 20	LT	1	1
Streak SRM 2	RT	1	1.5
Ammo (Streak) 50	RT	1	1
Small Laser	RT	1	.5

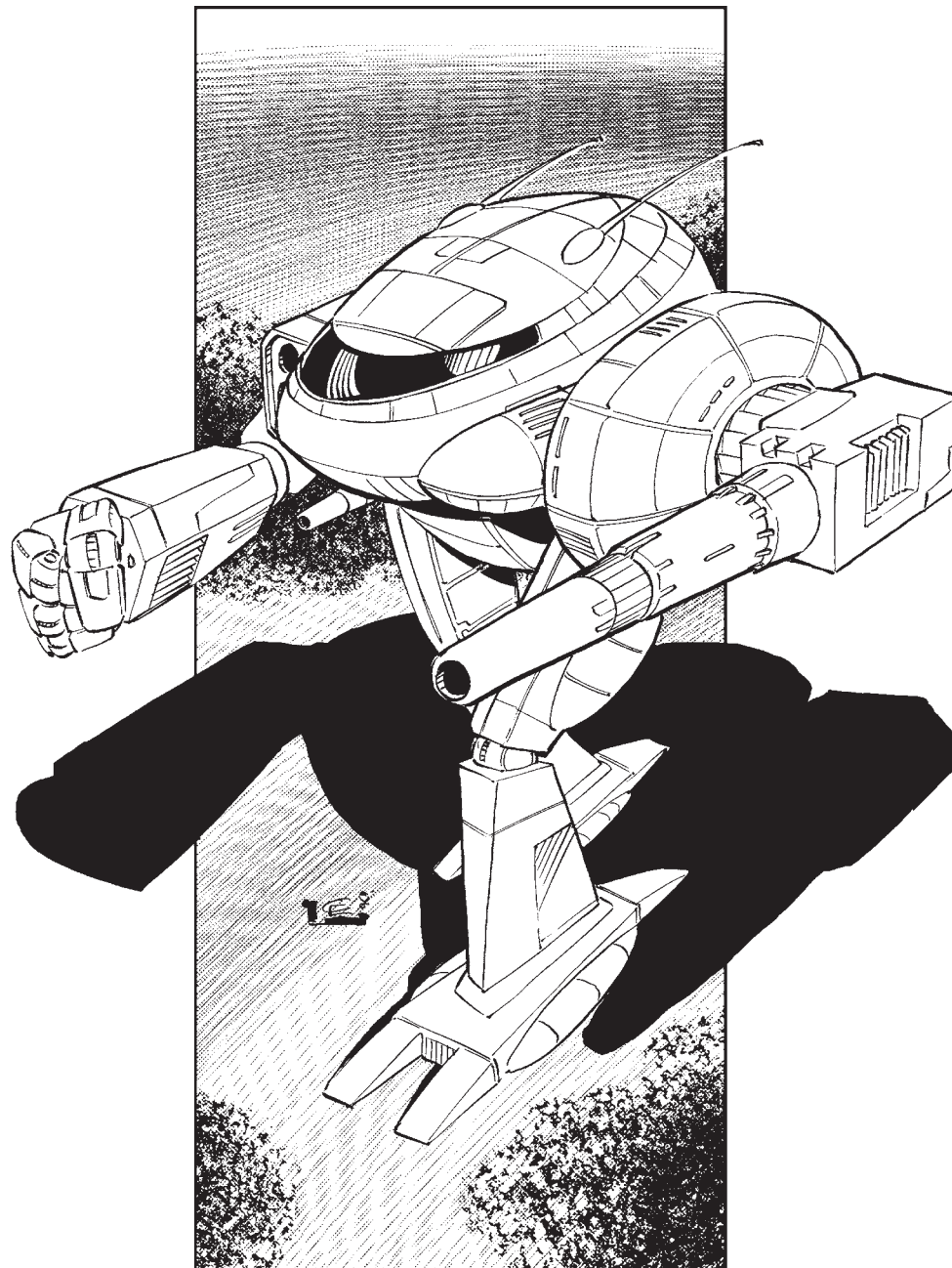

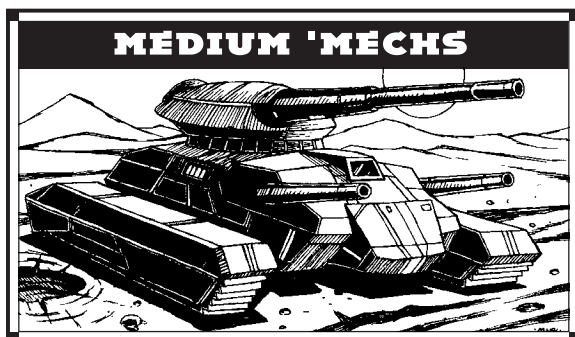

**Mass:** 45 tons

**Chassis:** Ost Endo Steel

**Power Plant:** GM 180

**Cruising Speed:** 43 kph

**Maximum Speed:** 64 kph

**Jump Jets:** Northrup 150

**Jump Capacity:** 120 meters

**Armor:** Kilosh 100 with CASE

**Armament:**

1 Jackson Dart LRM-10 Missile rack

1 Nightwind Large Laser

2 Starflash Small Lasers

1 Totschlagen SRM-6 Missile Rack

**Manufacturer:** Maltex Corporation

**Primary Factory:** Errai

**Communications System:** Ostman AMB

**Targeting and Tracking System:** Scrambler-7 Series

## Overview

Conceived as the ultimate urban war machine, the *Wyvern* was commissioned in late 2660. Despite its slow speed, evaluators were unanimous in their assessment that Maltex Corp exceeded all expectations with their innovative design. However, because its mission profile included “crowd control,” many MechWarriors felt there was a stigma to being assigned to this medium 'Mech. No one wanted to pilot a BattleMech meant to intimidate unarmed civilians.

Kilo for kilo, the *Wyvern* has no equal in urban combat. Indeed, in any movement-hindering environment—rocky badlands or city streets—the *Wyvern* can often defeat enemies well above its weight class. Though vulnerable to faster machines in open country,

the *Wyvern* remains a favorite of those who fight in broken terrain.

## Capabilities

Too often opponents focus on the *Wyvern*'s slow ground speed and overlook its Northrup jump jets. A 120-meter jump capacity allows the *Wyvern* to maneuver over and around obstacles other BattleMechs can't.

The right arm Northwind large laser is larger and heavier than most weapons of equal power and is arguably the most robust and reliable design available. A measure of the Northwind's over-engineering is that the brace of Starflash small lasers mounted on the same arm draw their energy directly from the Northwind's primary feed, yet all three weapons can fire at full power without overtaxing the system.

Also highly reliable is the *Wyvern*'s primary short-range weapon, the Totschlagen SRM-6 launcher. Though not as well known as the Holly SRM-6, the Totschlagen is a sturdy, battle-proven design. Of particular note is its compact ammo feed system mounted directly atop the CASE. The Totschlagen loader is fast and precise and can shave critical seconds off the reload time in combat. The loader's vertical assembly makes clearing jams possible through a maneuver known as the “schlagen hop”—the MechWarrior jumps the *Wyvern* up and down in place.

The one glaring weakness in the design is that space considerations forced designers to mount the Jackson-Dart LRM-10 in front of the fusion engine. Loading missiles must pass dangerously close to the core. In protracted combat situations, high temperatures force the missile feed system into thermal shutdown. MechWarriors who override the safety lock-outs risk having a salvo of missiles explode inside the loading tubes. To maintain their long-range punch, MechWarriors must carefully manage their heat.

## Deployment

There is not a Successor State military that does not field at least one *Wyvern*. Though slow moving by the standards of many, this hard-hitting urban scrapper has proven its usefulness and reliability again and again in obstructed or difficult terrain of every sort.

## Variants

Prior to the battle of Tukayyid, ComStar upgraded its *Wyverns* to the WVE-9N variant. This replaced the large laser with a pulse version and exchanged the SRM-6 for an SRM Streak-2. The heatsinks were upgraded to double-strength versions and the small lasers replaced with medium pulse lasers. Back in production in 3064, Maltex has since produced an upgraded version of the *Wyvern* for the Com Guard. The WVE-10N replaces the 9N's large pulse laser with an ER PPC, drops a medium pulse laser and the Streak SRM, and adds a Guardian ECM suite and C<sup>3</sup>i node.

## Notable MechWarriors

**Ward Dilmore:** In 3051 Grand Knight Galahad Frews led the Brotherhood of Randis in a raid against Antallos. Antallos was the hub of criminal activity along the rimward Periphery, a neutral world where pirates, hired guns, smugglers and self-styled bandit kings met to trade, form alliances, hire, and be hired. Frews had discovered the location of a long-forgotten Star League cache on Antallos and hoped to recover it for the Brotherhood. The cache was located in a region of the Shatter Waste badlands controlled by Fuchida's Fusiliers—a newly rogue mercenary force whose heavy and assault 'Mechs alone outnumbered the Brotherhood's total roster.

The Brotherhood's successful raid and stand against the Fusiliers became the stuff of legend and established the Knights as the premier MechWarriors in the spinward Periphery. When a lance of Fusilier assault 'Mechs tried to use a network of narrow arroyos to flank the Brotherhood's position, they found themselves stopped by what they estimated were a demi-company of *Wyverns*. Attacking individually, the 'Mechs jumped up and down escarpments the assaults could not traverse, scoring hits with lasers and missiles before disappearing. Though none were destroyed, the Fusilier 'Mechs could not advance against the harassing fire. Years later they learned Knight Ward Dilmore piloted the one and only *Wyvern* fielded by the Brotherhood of Randis.

Type: **Wyvern**

Technology Base: Inner Sphere

Tonnage: 45

Battle Value: 1,089

### Equipment

		Mass
Internal Structure:	Endo Steel	2.5
Engine:	180	7
Walking MP:	4	
Running MP:	6	
Jumping MP:	4	
Heat Sinks:	12	2
Gyro:		2
Cockpit:		3
Armor Factor:	152	9.5

	Internal Structure	Armor Value
Head	3	9
Center Torso	14	20
Center Torso (rear)		7
R/L Torso	11	16
R/L Torso (rear)		6
R/L Arm	7	14
R/L Leg	11	22

### Weapons and Ammo

	Location	Critical	Tonnage
LRM 10	CT	2	5
Ammo (LRM) 12	LT	1	1
CASE	LT	1	.5
Large Laser	RA	2	5
Small Laser	RA	1	.5
Small Laser	RA	1	.5
SRM 6	RT	2	3
Ammo (SRM) 15	RT	1	1
CASE	RT	1	.5
Jump Jet	LT	1	.5
Jump Jet	RT	1	.5
Jump Jet	LL	1	.5
Jump Jet	RL	1	.5

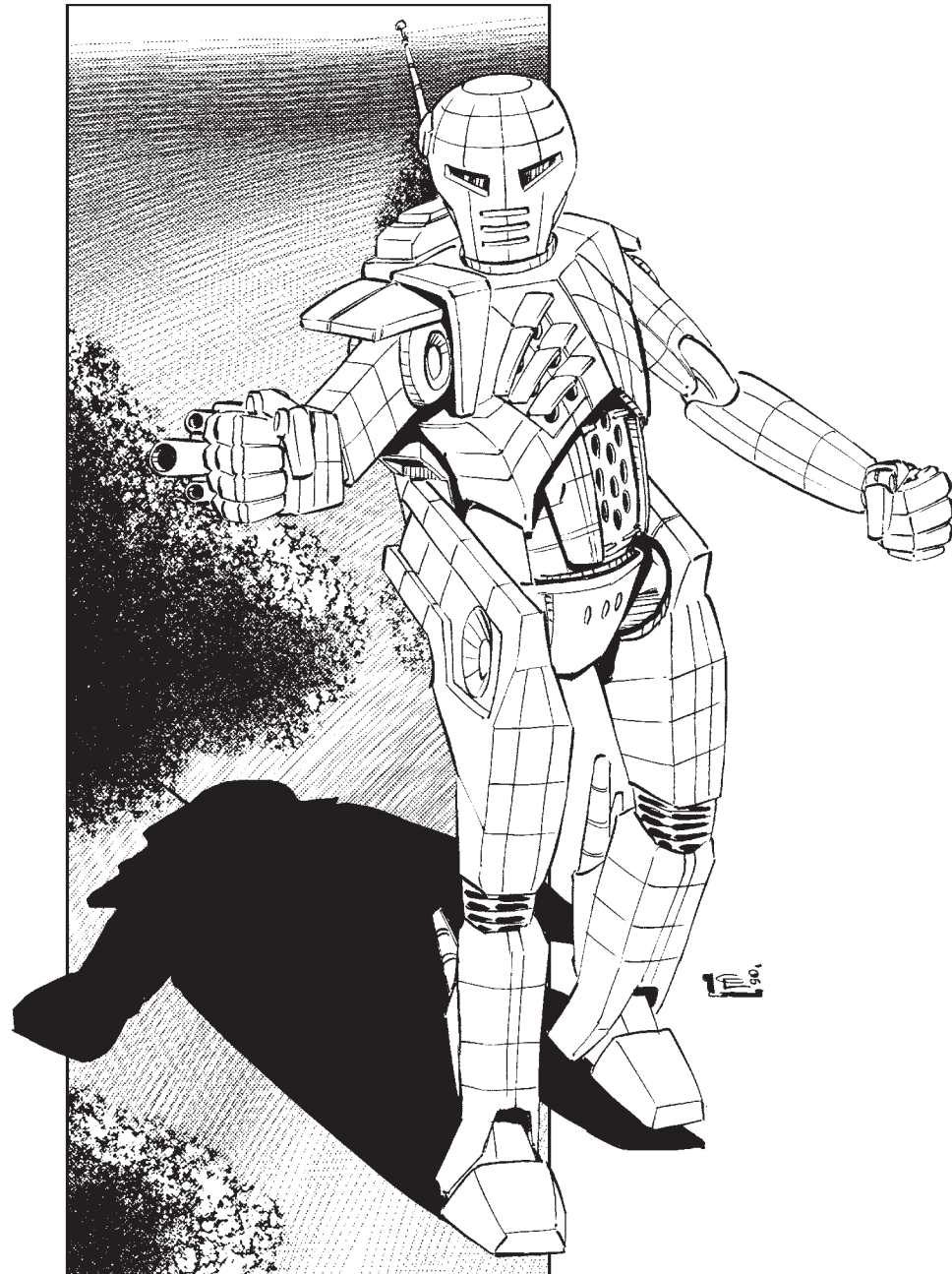

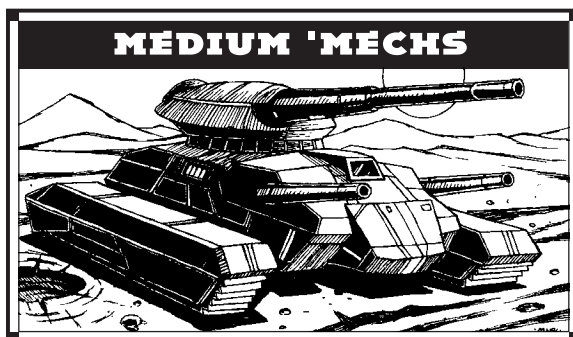

**Mass:** 50 tons

**Chassis:** Hollis Mark 1A

**Power Plant:** Magna 250

**Cruising Speed:** 54 kph

**Maximum Speed:** 86 kph

**Jump Jets:** None

**Jump Capacity:** None

**Armor:** Paulina Ferro-Fibrous

**Armament:**

2 RAMTech 1200 Large Lasers

1 Ceres Arms Medium Laser

1 ExoStar Small Laser

**Manufacturer:** Cosara Weaponries

**Primary Factory:** Northwind

**Communications System:** Dalban Series K/  
Garret T11-b

**Targeting and Tracking System:** 650 RND/  
Garret D2j

## Overview

When built for the Star League in 2719, the approach taken by Cosara Weaponries was to create a BattleMech that was easily maintained and well suited to high endurance raiding far from supply lines. With only its sophisticated targeting and communications systems considered cutting-edge (the ferro-fibrous armor it carried was considered proven technology in its day), the *Crab* was seen by many as a reliable standby and the eventual standard for SLDF medium 'Mechs. The League's collapse orphaned the design, however, and the loss of ferro-fibrous production eventually led to centuries where the surviving units were downgrad-

ed to carry standard armor, but the *Crab's* elegant simplicity practically assured that enough would survive to the present era.

## Capabilities

The *Crab's* good land speed and all-laser weapons load enabled it to excel as a raider far from supply lines. To facilitate this, its original communications and targeting systems were designed to interface with local satellite networks and other communications innovations of its day to provide its pilot with unparalleled recon data capabilities. Indeed, the combination of the Dalban Series K and the 650 RND systems allowed the *Crab's* computers to forecast enemy troop movements, but the sophistication of these systems and the ravages of the Succession Wars eventually saw their decline by the end of the Succession Wars, when most of the remaining *Crabs*—except those maintained by ComStar—had to make do with off-the-shelf equivalents.

## Deployment

Most of the *Crabs* active today are found in the arsenals of the Com Guards, the Word of Blake, the Draconis Combine, and certain second-line Clan forces. Many of these are from the original production run for the first Star League—a testament to the design's survivability—though Cosara resumed *Crab* production on Northwind during the 3050s, and rumors abound that ComStar has sold the design specs to the Rasalhague government to produce the CRB-30 model.

## Variants

As ferro-fibrous technology grew scarce in the early Succession Wars, the downgraded CRB-20 emerged with standard armor plate. As the bulk of the *Crab's* other systems consisted of widely available components, these variants were far easier to maintain than most Star League relics, and there were still an estimated hundred or so left in circulation by the time the Helm core made possible a refit back to the original model 27 designs.

The rise of C<sup>3</sup> technologies in the 3050s and 3060s spawned a pair of newer *Crab* variants. The Draconis

Combine's CRB-C variant emerged first in the mid-50s with a C<sup>3</sup> Slave unit installed in place of the centerline medium laser. The ComStar/Word of Blake CRB-30 package was more extensive, with an extra-light engine installed to make room for a C<sup>3</sup>i unit, a Guardian ECM suite, and a complete weapons upgrade utilizing ER PPCs and extended-range small and medium lasers. Fourteen double-strength heat sinks help control the 'Mech's considerable heat curve.

A new variant, dubbed the CRB-45, reportedly debuted in Word of Blake formations operating on Dieron. These handless variants boast a trio of Light PPCs, backed by a centerline-mounted ER large laser. Improved heavy ferro-fibrous armor enables these machines to carry similar armor levels to the CRB-30 despite having a larger XL engine for a twenty percent speed increase. These machines also use the C<sup>3</sup>i system and have enough heat sinks to remain cool even when cutting loose with every weapon. Considered too radical to be a mere field refit, the origins of these new *Crabs* remain unclear at this time, but some analysts suggest that the Word might have upgraded the captured Cosara Weaponries factories on Northwind.

## Notable MechWarriors

**Adept Rho/Rho Judith “Rapier” Faber:** Trained as an operative for Blake's Wrath, ComStar's elite special forces command, Adept Faber—codenamed Rapier—was among several operatives who deliberately allowed themselves to be captured during the Battle of Tukayyid as part of a deep cover assignment to learn the location of the Clan homeworlds. Faber—who sacrificed her CRB-27 *Crab* against the Smoke Jaguars at the Racice River Delta—eventually befriended and turned a Jaguar named Trent, which helped her learn the location of Huntress itself, leading directly to the end of the Clan Wars. Since then, Faber returned to duty with the Wrath, rewarded for her efforts with a prize Marauder IIC. Faber was reportedly killed in 3067 while engaging Blakist forces in the Chaos March, shortly before the start of the Jihad, but neither her body nor her 'Mech were ever recovered.

# CRB-27 CRAB

Type: **Crab**

Technology Base: Inner Sphere

Tonnage: 50

Battle Value: 1,198

## Equipment

		Mass
Internal Structure:		5
Engine:	250	12.5
Walking MP:	5	
Running MP:	8	
Jumping MP:	0	
Heat Sinks:	16	6
Gyro:		3
Cockpit:		3
Armor Factor:	161	9

	Internal Structure	Armor Value
Head	3	9
Center Torso	16	20
Center Torso (rear)		8
R/L Torso	12	16
R/L Torso (rear)		6
R/L Arm	8	16
R/L Leg	12	24

## Weapons and Ammo

	Location	Critical	Tonnage
Large Laser	LA	2	5
Large Laser	RA	2	5
Medium Laser	CT	1	1
Small Laser	H	1	.5

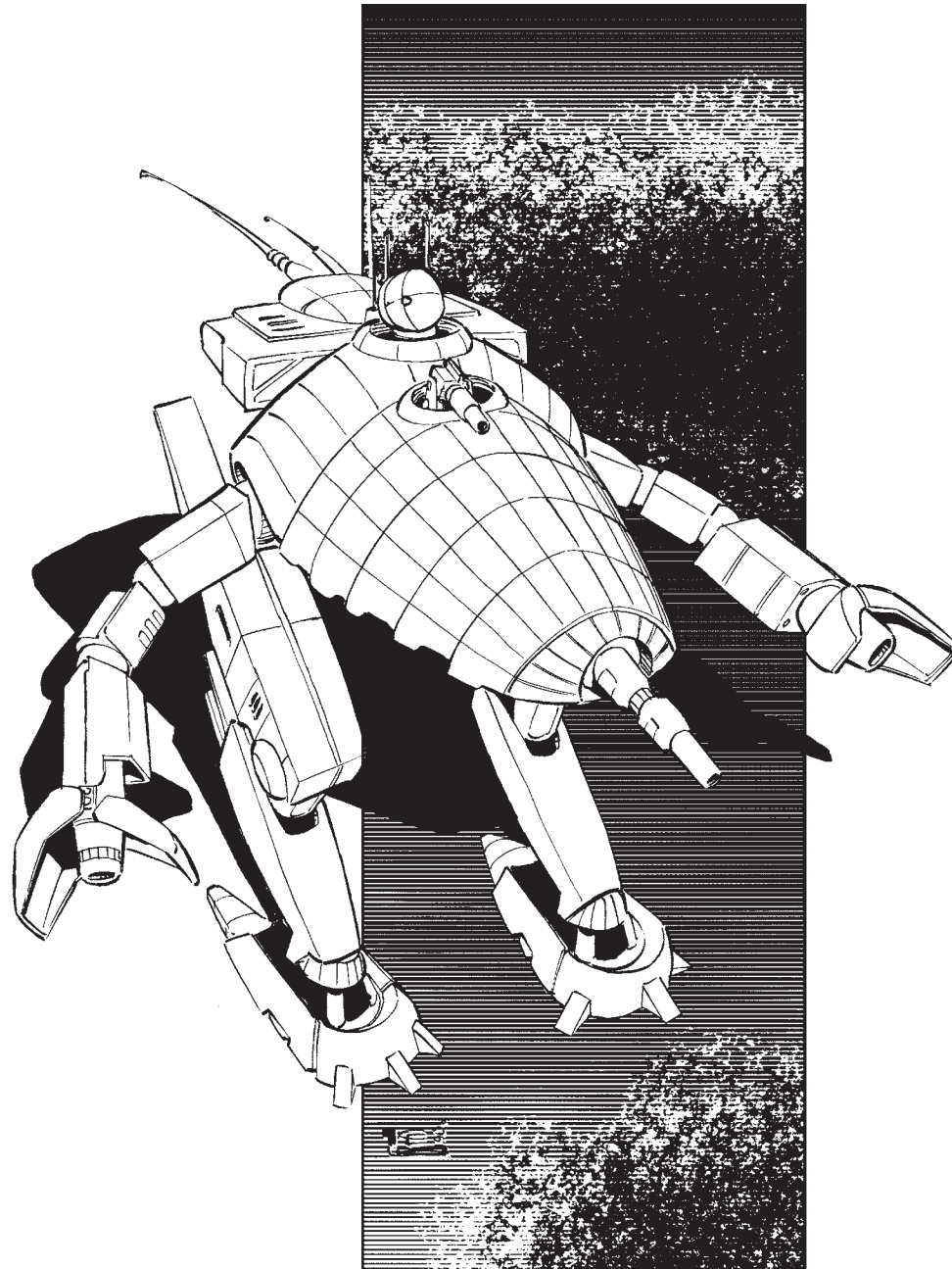

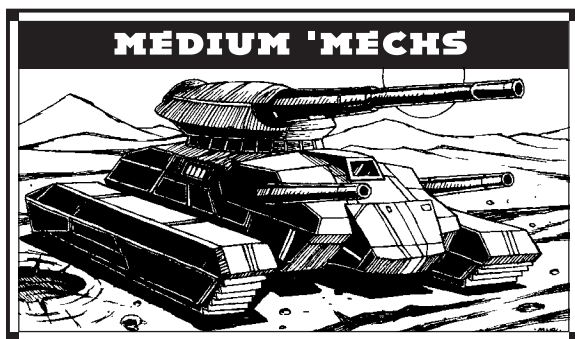

**Mass:** 55 tons

**Chassis:** Technicon-1

**Power Plant:** Core Tek 275

**Cruising Speed:** 54 kph

**Maximum Speed:** 86 kph

**Jump Jets:** None

**Jump Capacity:** None

**Armor:** Leopard V Ferro-Fibrous

**Armament:**

1 Magna Mk. III Large Laser

1 Holly LRM-5 Missile Rack

2 Hovertec SRM-6 Missile Racks

2 Magna Mk. II Medium Lasers

**Manufacturer:** General Mechanics

**Primary Factory:** Mars

**Communications System:** OmniComm 3

**Targeting and Tracking System:** Starbeam 3000

## Overview

When ComStar took command of Terra, it inherited not only a significant amount of military materiel, it also took charge of the system's many prodigious armaments factories. Though ComStar ultimately mothballed those factories, it nonetheless sat upon the largest military stockpile in the Inner Sphere. The *Kintaro*, a medium BattleMech in those warehouses, was one of the designs ComStar supplied the Draconis Combine during the 3030s. Though stripped of its advanced technology, it nonetheless proved a valuable addition to the Combine's rapidly expanding military, as well as to the Com Guards and, later, the Word of Blake.

## Capabilities

The KTO-19 *Kintaro* was originally designed around the Narc missile beacon, mounting complementary short and long-range missile launchers. When ComStar gave the 'Mechs to the Combine, ComStar technicians stripped the Narc launcher out, replacing it with a standard large laser from their warehouses. Supported by a pair of arm-mounted medium lasers and the SRMs, the KTO-20 *Kintaro* has a powerful short-range punch, although it is designed to wear down or finish off a target rather than deliver crippling blows. Something of an afterthought, the single LRM-5 launcher allows the 'Mech to harass opponents from range.

Its real strength comes from its mobility and hearty armor protection. A CoreTek 275 fusion engine gives the *Kintaro* a maximum speed of just under 90 kph, making the 'Mech a capable cavalry brawler. Ten full tons of ferro-fibrous armor—the bit of lostech, along with double heat sinks, that ComStar chose not to strip from the 'Mech—give it superior protection. Considering the 'Mech's typical combat profile of “get in and get out,” most *Kintaro* pilots believe it is sufficient.

## Deployment

Both ComStar and the Word of Blake militia widely deploy the *Kintaro*, having placed it in every division. Apparently, the Word of Blake restarted production of the 'Mech on Mars several years ago and has created a number of Level II formations solely of *Kintaro* variants, giving them ideal spotters for both their fire-support formations as well as C<sup>3</sup>i-equipped battle groups. Based on Jihad battlefield reports, it is clear that the Word of Blake also supplied many of their mercenary units with the *Kintaro* as well.

The great majority of the Draconis Combine's *Kintaros* reside within the Ghost Regiments, those units that were secretly raised during the 3030s using ComStar-provided materiel and manned with *yakuza*-trained MechWarriors. Many also operate within the Sword of Light regiments.

## Variants

ComStar and the Word of Blake both field the KTO-21 *Kintaro* variant that drops the LRM rack, upgrades

the lasers to ER versions and mounts both iNarc and C<sup>3</sup>i systems. This was the first 'Mech that carried both of these high-tech advancements into battle, proving their success during the assault on the Clans and the FedCom Civil War.

The Combine fields its own *Kintaro* variants, the first of which removes one of the medium lasers to make room for a C<sup>3</sup> slave. The second drops the large laser and LRM rack to mount jump jets, upgrades the SRM launchers to Streak versions with CASE-protected ammunition stores, adds a third medium laser—all likewise upgraded to ER versions—and includes an increasingly standard C<sup>3</sup> module.

## Notable MechWarriors

**Chu-sa Rachel Sakurai:** Assigned as the Combine's military attaché to ComStar on Orestes, *Chu-sa Sakurai* found herself embroiled in a rabid battle between ComStar and the Word of Blake when the Jihad finally struck the world. Rather than allow herself to be caught up in the fury, she focused her energies on protecting the citizens of the world, working with local police and Orestes militia to keep the streets safe from the roving war bands. Twice her *Kintaro* has suffered crippling strikes while she was protecting a civilian shelter, and both times she was saved at the last minute by the timely arrival of militia reinforcements.

**Adept IV Thim Nho:** The lynchpin in the Blakist Eighth Division's Dragon's Teeth battalion-sized hunter-killer strike team, Adept Nho and her comrades infiltrate enemy lines to sow their insidious seeds upon their unsuspecting enemies. “Tagging” enemy 'Mechs with a variety of iNarc electronics pods, they lay the groundwork for the rest of their Level III, or even the entire division, to come in and lay waste to a group as large as a force of assault 'Mechs. Since the beginning of the Jihad, she and the other members of her Level III have claimed hundreds of kill assists, marking her as a target for many bounty hunters looking to claim the sizeable price on her head.



# KTO-20 KINTARO

MEDIUM 'MECHS

201

Type: **Kintaro**

Technology Base: Inner Sphere

Tonnage: 55

Battle Value: 1,357

## Equipment

		Mass
Internal Structure:		5.5
Engine:	275	15.5
Walking MP:	5	
Running MP:	8	
Jumping MP:	0	
Heat Sinks:	10 [20]	0
Gyro:		3
Cockpit:		3
Armor Factor:	179	10

	Internal Structure	Armor Value
Head	3	9
Center Torso	18	26
Center Torso (rear)		10
R/L Torso	13	18
R/L Torso (rear)		8
R/L Arm	9	18
R/L Leg	13	23

## Weapons

And Ammo	Location	Critical	Tonnage
2 Medium Lasers	RA	2	2
SRM 6	LA	2	3
LRM 5	RT	1	2
SRM 6	RT	2	3
Ammo (SRM) 15	RT	1	1
Ammo (LRM) 24	LT	1	1
Ammo (SRM) 15	LT	1	1
Large Laser	CT	2	5

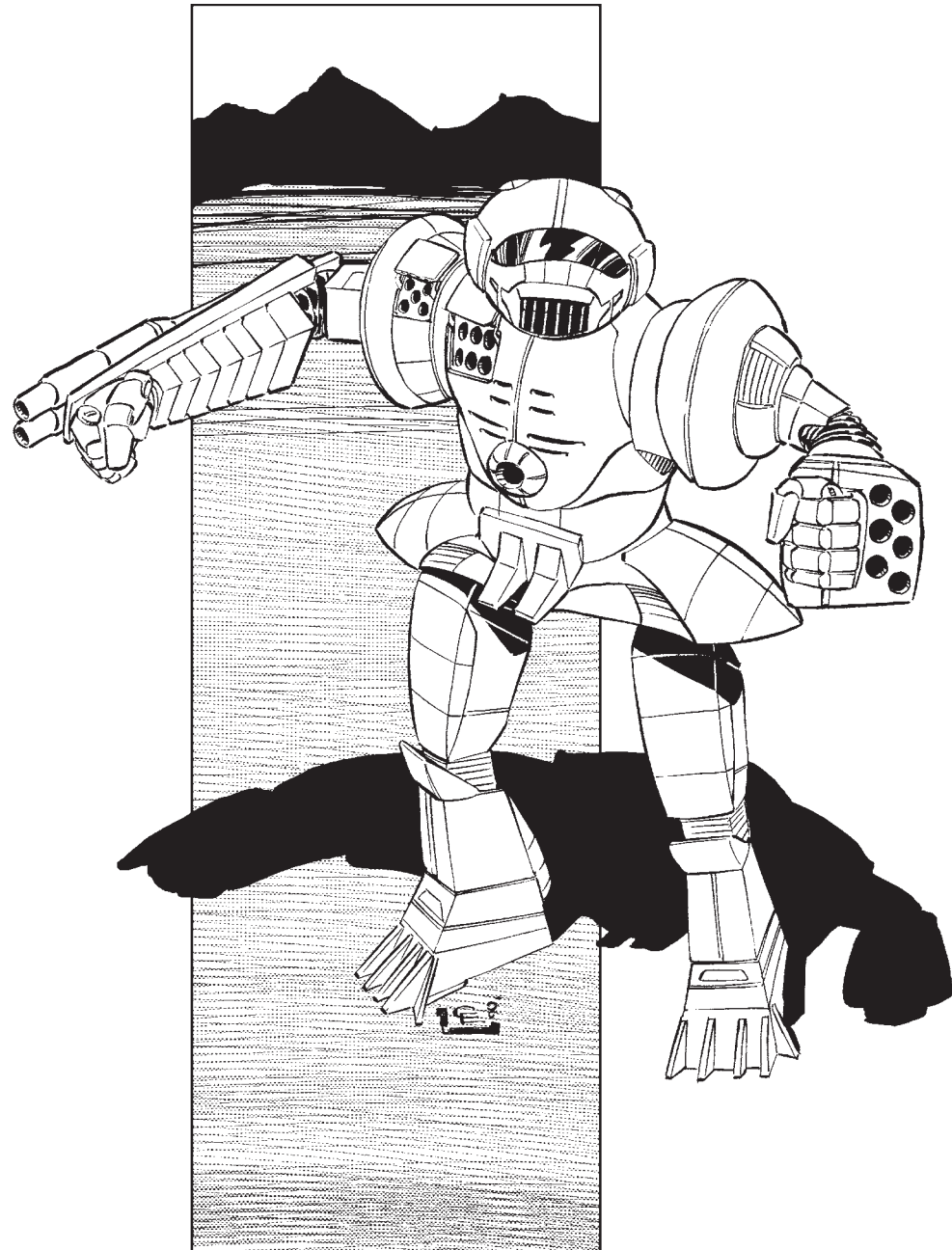

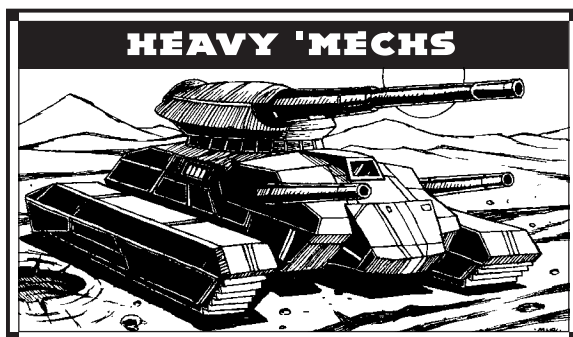

**Mass:** 60 tons  
**Chassis:** Bergan XI  
**Power Plant:** Vlar 300  
**Cruising Speed:** 54 kph  
**Maximum Speed:** 86 kph  
**Jump Jets:** None  
**Jump Capacity:** None  
**Armor:** StarSlab/2 Ferro-Fibrous  
**Armament:**  
1 Lubalin LB 10-X Autocannon  
1 Harpoon-6 SRM Launcher  
2 Magna MkII Medium Lasers  
2 Martell Small Lasers  
**Manufacturer:** Bergan Industries  
**Primary Factory:** New Earth  
**Communications System:** Garrett T-11 C  
**Targeting and Tracking System:** Mercury-IV  
with Artemis IV FCS

## Overview

Introduced in 2602, the CHP-1N *Champion* was designed to be a fast and maneuverable heavy BattleMech, able to fit into a variety of combat roles. Principally intended as a heavy recon or light strike platform, the design proved popular during the golden years of the Star League where it was employed in a variety of brush wars. Not all regarded the *Champion* as a success, however; its light armor and armament drew criticisms from those who felt its task would be better accomplished by a lighter design such as the *Griffin*.

## Capabilities

Though many other BattleMechs in the *Champion's* weight class are more heavily armed and ar-

mored, few can match its speed and maneuverability and, thus, its higher survival rate. However, to achieve this speed advantage, the 'Mech uses a massive Vlar 300 fusion engine that takes up almost a third of the design's mass. When combined with the ammunition-dependent weapon systems—a Lubalin Ballistics 10-X autocannon and a Harpoon-6 short-range missile launcher—and the mediocre secondary laser weapons (which cause severe heat-management issues), it is a wonder the design achieved the popularity it did. However, with large-scale battles a thing of the past in the 27th century, replaced by duels and conflicts in which maneuver and tactical positioning played a key role, the abilities of the *Champion* came to the fore. The initial order was soon repeated and several licensed versions appeared with house militaries, most notably the AFFS where the design proved itself invaluable during Zane Davion's rule.

The Amaris Coup and the Succession Wars destroyed large numbers of the *Champion* though a number survived, most notably within the Com Guard. The returning Clans brought several examples in their second line forces too, though these have largely disappeared from sight.

## Deployment

Although mainly appearing as a legacy design within ComStar's forces, production of the *Champion* resumed in limited quantities at the old Bergan Industries facilities on New Earth in the late 3050s. The fate of this factory in the current conflict is unknown.

## Variants

The new-build *Champions* are functionally identical to their Star League equivalents, though a number of models utilized a field modification popular in the Star League that replaced their traditional heat sinks with double-strength units.

The Clan models diverge a little from the SLDF design, mounting advanced heat sinks as standard and employing an XL-series engine to allow the installation of additional armor and weaponry, including upgrading all the lasers to pulse variants.

ComStar's *Champion* variant drops the SRM launcher in favor of iNarc (also adding a C3i system)

and replaces all the lasers with ER Mediums. Additionally, this CHP-3P employs an Ultra AC-10 instead of the LB-X, making room for these systems—and adding extra heat sinks, upgraded to the double-efficiency variety—by swapping the Vlar powerplant for an XL model.

## Notable MechWarriors

**Demi-Precentor Vanye Highfield:** A veteran of both Tukayyid and Operation Bulldog, Vanye Highfield became one of the best-known Com Guard officers on Luthien where he was stationed until the Blakist troubles began. Known at the Kurita court for his wit and charm as much as his skills in a 'Mech, he became a close associate of Hohiro Kurita with whom he often carried out 'Mech exercises, Highfield's *Champion* and his Com Guard associates against the Prince's personal lance. The honors were tied overall and Kurita is known to have praised Highfield's force highly, particularly the hit-and-fade tactics at which the *Champion* excelled.

Highfield was recalled to Tukayyid at the outbreak of hostilities and took part in Case White, where he is believed to have perished.

**Force Commander Pasi Irin:** A handful of *Champions* arrived in the Free Worlds with the Word of Blake after the failure of Operation Scorpion in 3052, though the variants handed over to the FWLM were largely compromised and missing the elements of advanced technology employed by the design in much the same manner as the equipment provided by ComStar to the DCMS before the War of 3039 was neutered. A few designs slipped through untouched, however, and one was the example assigned to Pasi Irin of the First Free Worlds Legionnaires. Somewhat underwhelmed by the "advanced" design, tech-savvy Irin carried out a number of field modifications on the *Champion*, designed to improve its heat-management and endurance. Replacing the SRM launcher and its advanced FCS system with a pair of Streak SRM-2 launchers freed up space within the chassis that was used for additional armor.

# CHP-1N CHAMPION

Type: **Champion**

Technology Base: Inner Sphere

Tonnage: 60 tons

Battle Value: 1,233

## Equipment

		<b>Mass</b>
Internal Structure:		6
Engine:	300	19
Walking MP:	5	
Running MP:	8	
Jumping MP:	0	
Heat Sinks:	10	0
Gyro:		3
Cockpit:		3
Armor Factor:	143	8

	<i>Internal Structure</i>	<i>Armor Value</i>
Head	3	9
Center Torso	20	24
Center Torso (rear)		8
R/L Torso	14	18
R/L Torso (rear)		6
R/L Arm	10	12
R/L Leg	14	15

## Weapons and Ammo

	<b>Location</b>	<b>Critical</b>	<b>Tonnage</b>
SRM 6	LT	2	3
Artemis IV FCS	LT	1	1
Ammo (SRM) 15	LT	1	1
2 Medium lasers	LT	2	2
2 Small Lasers	CT	2	1
LB 10-X AC	RT	6	11
Ammo (LB-X) 20	RT	2	2

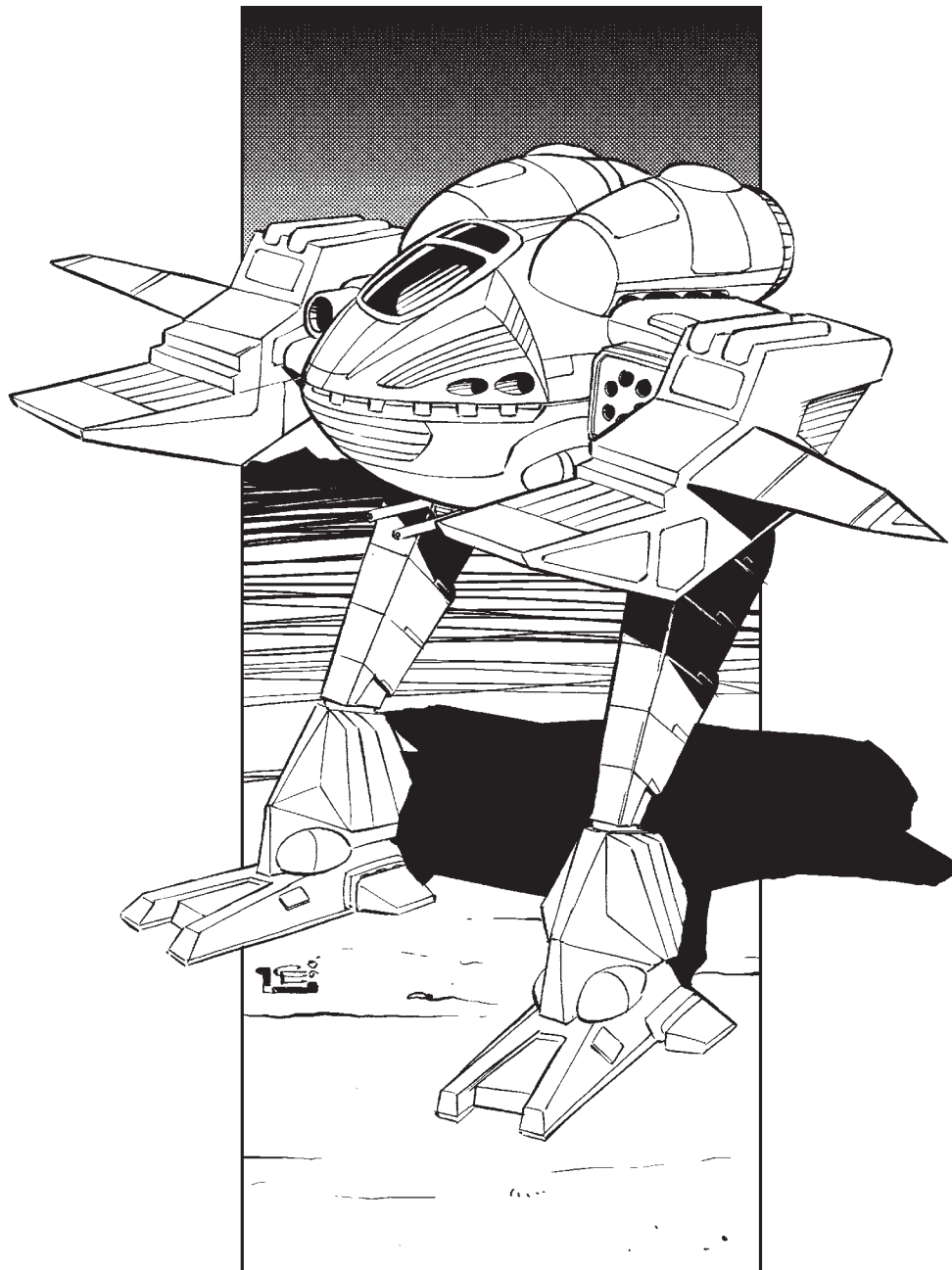

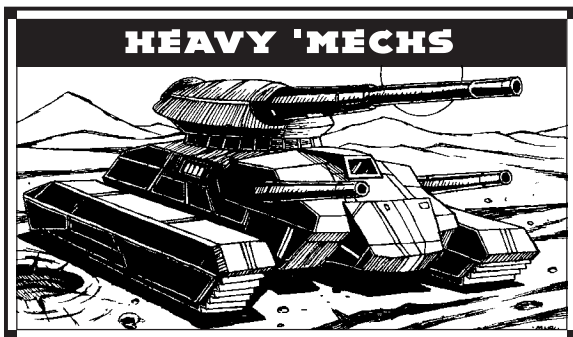

**Mass:** 60 tons

**Chassis:** MangoTech 500SJ

**Power Plant:** Hermes 360 XL

**Cruising Speed:** 64 kph

**Maximum Speed:** 97 kph

**Jump Jets:** None

**Jump Capacity:** None

**Armor:** PanzerSlab Type 5

**Armament:**

1 Kinslaughter PPC

2 Krupp Model 32 Large lasers

1 Krupp Model 2 Medium Laser

**Manufacturer:** Krupp Stellar Technologies Inc.

**Primary Factory:** Mars

**Communications System:** Krupp-COMM 500

**Targeting and Tracking System:** KBC Starsight Model 3

## Overview

Released in 2581 for mobile units sent on extended missions, the *Lancelot* was a superior design at the time. Using some of the most advanced technology at the time, the sixty-ton BattleMech still maintains a reputation as a swift fighter competing with many more contemporary designs. Its respect was such that then-Precentor Martial Anastasias Focht, shortly after Tukayyid, commissioned and rebuilt the Krupp Stellar factory on Mars to resume *Lancelot* production.

## Capabilities

Built around a Hermes extra-light fusion engine, the *Lancelot* can maintain speeds of almost one hun-

dred kilometers per hour. Further, not a single weapon on the BattleMech requires ammunition. A pair of arm-mounted large lasers, a medium laser, and a supporting particle projection cannon provide excellent damage output for its size.

The *Lancelot's* Star League-era battle computer, the KBC Starsight Model 3, can track and prioritize hundreds of targets and projectiles at the same time, making it an excellent anti-aircraft BattleMech. In fact, records indicate that the *Lancelot* was replacing the *Rifleman* as the Star League's standard anti-aircraft BattleMech, but the Amaris Coup put an end to that trend while in mid-transition.

## Deployment

On Al Na'ir, a level II consisting of a trio of *Lancelots* was credited with disposing of a lance of *Atlases* that had so far successfully defended the system's major production facility. Using their comrades to relay targeting data to them, the long-range brawlers pounded away at the *Atlases* in the vacuum environment until they penetrated the side torsos, disabling the heavier 'Mechs' extra-light engines. By the end of the fight, only the *Lancelots* left the field under their own power.

On Liao, many *Lancelots* were assigned to keep the skies safe from attacking Hell's Black Aces aerospace fighters during the Blakists' initial push. Although their state-of-the-art battle computer and improved C<sup>3</sup>i made them feared by the Aerojocks, even these machines were unable to turn the tide of battle when the Word of Blake attempted to establish a beachhead for the first time outside Liao's capital city, which was foiled by several suicide runs by Black Ace fighters.

## Variants

A popular design among those who fought alongside it, the *Lancelot* has several different configurations in circulation. Designed to fight against conventional support, the 05 variant replaces heat sinks and the medium laser with low-tech machine guns. The 04 variant produced on Mars for the Com Guards shortly before the Blakist takeover was built around an endo-steel chassis and carried extended-range lasers and an improved C<sup>3</sup> network. The Blakists took this variant

a step further with their 06 model spotted within the last year. Salvaged under fire during a skirmish with the Heart of Blake mercenary unit, this former Blakist unit volunteered the wreckage to the AMC in a gesture of goodwill. Technical experts noted the integration of an extra-light gyro and an advanced targeting system with a compact cockpit. The only odd item of note is that the particle projection cannon is an older, standard model, and not the ER version most expect.

A rarity outside the fractured ComStar and the Draconis Combine, few *Lancelots* survived the Succession Wars. Those that did have been heavily modified through damage; without the proper spare parts, most of these machines had the extra heat sinks and the large lasers removed to mount their more rugged ballistic counterparts, the class-5 autocannons. Not many of the 03 variant are available, but the Word of Blake has reportedly begun to modify their crippled 06 *Lancelots* in a similar way, though they exchange their damaged large lasers with a pair of LB 5-Xs. To make room for the modification, the now-unnecessary advanced targeting system is removed, and the armor is replaced with a newly acquired light ferro-fibrous composite.

Lastly, Luthien Armor Works managed to obtain copies of the *Lancelot's* blueprints after the Second Succession War. Unable to reproduce the 'Mech's advanced engine, heat sinks, and electronics, the downgraded 02 variant still packs a considerable punch, though it was a poor heir of its more capable ancestor.

## Notable MechWarriors

**MechWarrior Neil Anthony:** Anthony received one of the first *Lancelots*, which he used in the Reunification War to single-handedly defeat some 57 Taurian BattleMechs. This was regrettable for the rest of his regiment, since Anthony was an egomaniac braggart whose favorite topics were the many men he'd seduced and the schoolyard foes he'd beaten before he ever took to a real battlefield. Becoming an Inner Sphere media darling and getting his piloting methods into textbooks made him even more insufferable to his fellow soldiers.

# LNC25-01 LANCELOT

Type: **Lancelot**

Technology Base: Inner Sphere

Tonnage: 60

Battle Value: 1,422

## Equipment

		Mass
Internal Structure:		6
Engine:	360 XL	16.5
Walking MP:	6	
Running MP:	9	
Jumping MP:	0	
Heat Sinks:	13 [26]	3
Gyro:		4
Cockpit:		3
Armor Factor:	152	9.5

	Internal Structure	Armor Value
Head	3	7
Center Torso	20	21
Center Torso (rear)		16
R/L Torso	14	16
R/L Torso (rear)		10
R/L Arm	10	14
R/L Leg	14	14

## Weapons and Ammo

	Location	Critical	Tonnage
PPC	RT	3	7
Large Laser	RA	2	5
Large Laser	LA	2	5
Medium Laser	CT	1	1

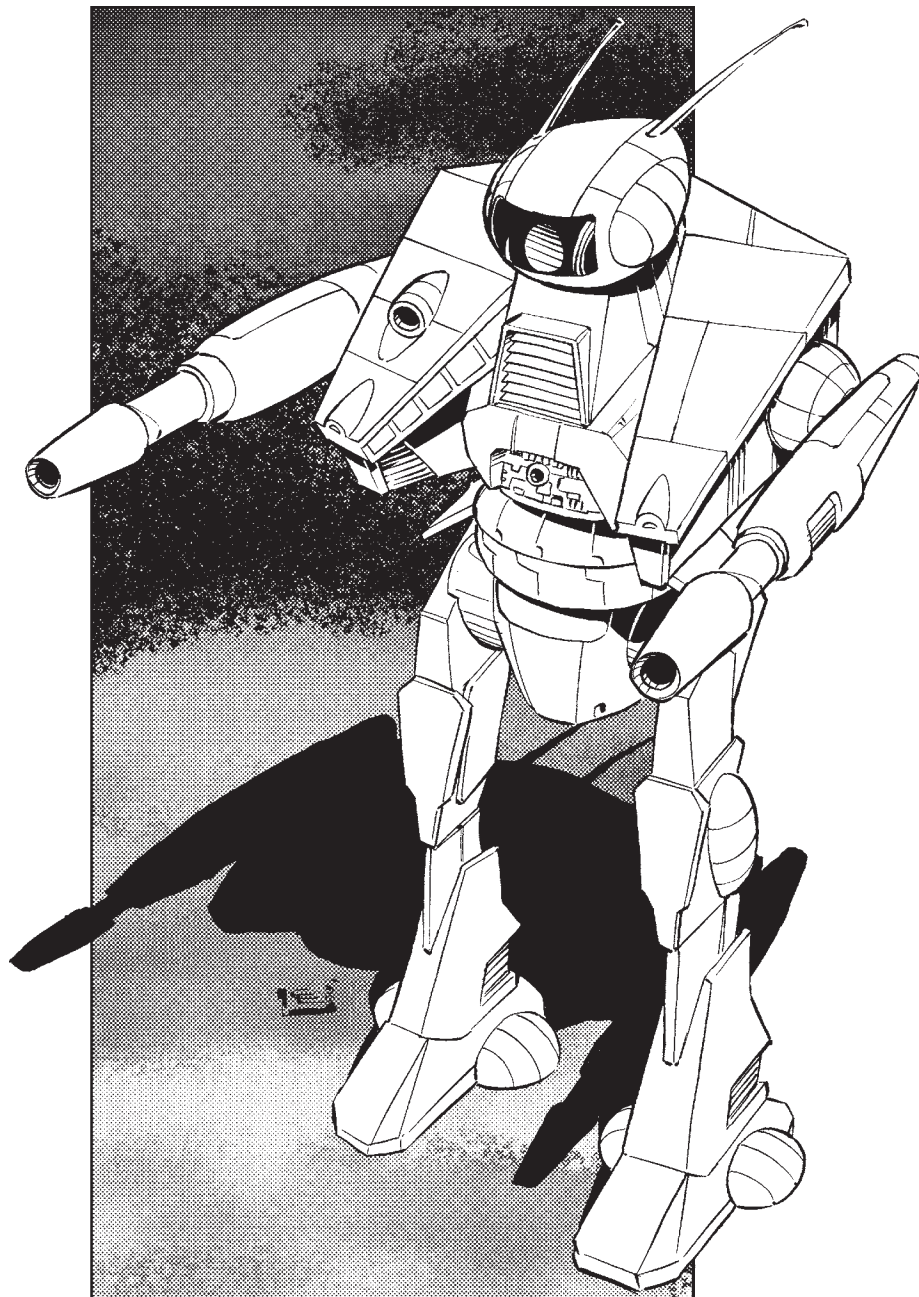

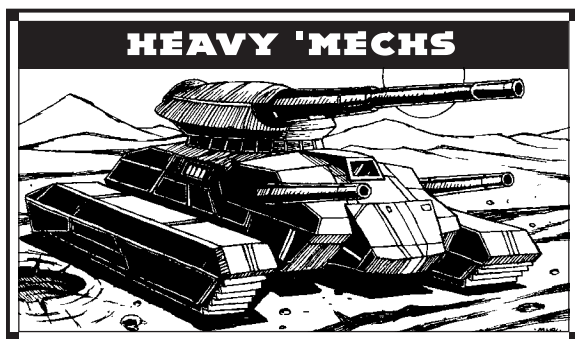

**Mass:** 65 tons

**Chassis:** KetoBond

**Power Plant:** VOX 325 XL

**Cruising Speed:** 54 kph

**Maximum Speed:** 86 kph

**Jump Jets:** None

**Jump Capacity:** None

**Armor:** Choutaka Armorscale, Ltd., with CASE

**Armament:**

2 Delphinus-20 LRM Launchers

1 Arrowlite-4 SRM Launcher

1 Buzzsaw Anti-Missile System

**Manufacturer:** Wakazashi Enterprises

**Primary Factory:** Al Na'ir (destroyed  
First Succession War)

**Communications System:** Neil 9000

**Targeting and Tracking System:** DLK Type Phased  
Array Sensors

## Overview

A Star League design specialized in artillery support, the *Bombardier* faded from the Inner Sphere during the Succession Wars. With its primary factories destroyed and the engineering plans lost, Wakazashi left the design to die off, refusing to even produce common-knowledge spare parts for the 'Mech. With its primary manufacturer shifting its focus to aerospace design and production, the *Bombardier* suffered from poor maintenance and low opinion, dooming it to extinction—one more BattleMech design on the scrap heap of history.

Enter Clan Snow Raven and the Outworlds Alliance.

Though little is known about the deals struck with the Alliance, it is becoming apparent that the appear-

ance of a massive factory complex, Clan enclave, and even a DropShip repair facility on Mitchella is directly tied to the sudden bonding of a Home Clan with the mediocre Periphery power. When the Alliance debuted what appeared to be new *Bombardiers*—in the hands of their Grenadiers, no less—during a massive raid against Enif, Combine agents along the border sat up and took notice. The once-timid and heavily aerospace-dependant Alliance was somehow mass-producing effective fire-support 'Mechs.

## Capabilities

The *Bombardier* is efficient in its assigned fire-support role. Its large power-plant allows the 'Mech to advance more quickly than most fire-support 'Mechs, allowing field commanders the luxury of quickly re-positioning such assets as needed. Though the ammo is only considered adequate at best, the machine is well armored, allowing it to survive to the next ammo depot.

## Deployment

Still in some prevalence across the Inner Sphere, the BMB-10Ds (low-tech versions of the 12Ds) and -12Ds generally see service as a walking pile of spare parts; all the more surprising to see apparent new BMB-12Ds in Alliance forces. The Delphinus LRM-20s are more often found as replacement launchers in other, more effective support 'Mechs such as *Archers*, *Apollos*, and *Catapults*. If either model is found in working condition, it is usually a sign that the unit fielding it is on its last legs.

ComStar still fields a limited quantity of BMB-14Cs, though with the latest blows to the organization by the Blakist fanatics it is unknown just how many of these still survive.

A new, highly powerful variant has recently been spotted among Alliance forces as well, leading many to believe that the original “new” BMB-12Ds were simply test-bed models for the more advanced “BMB-05A.”

## Variants

Featuring an endo-steel chassis—suggesting that ComStar may have had a facility to produce these 'Mechs at some point—and removing the anti-missile system, the -14C adds a C<sup>3</sup>i computer and Artemis fire control for the LRMs while upgrading the small laser to an ER model.

The new BMB-05A *Bombardier* contains an Arrow IV artillery launcher, capable of delivering devastating strikes well out of reach of most conventional units. For heavier punch, a series of newly-designed Doombud rocket pods allows a *Bombardier* pilot the flexibility to deliver an on-site blow that could deliver a destructive force—but only once. The small laser seems almost an afterthought, more placed for the pilot's reassurance than any real strategic thinking. Cheap to build—the most expensive component is the Shigunga Arrow IV system (imported, oddly enough, from the Combine through a FedSuns mercantile intermediary)—the -05A is finding wide acceptance with many of the Alliance's militias.

Curiously, the Draconis Combine has also begun fielding new *Bombardier* variants. Equipped with a preponderance of new multi-missile launchers, these 'Mechs are apparently older -10D and -12D designs that were mothballed for parts by Wakazashi, as almost every encounter shows an older frame with the obviously new MML system reworked into the missile mounts. (The company is rumored to be under investigation by the ISF for the apparent mismanagement that “lost” over a battalion of these 'Mechs more than a century ago.) Instead of the standard AMS or machine gun, a newer MG array with a triad of guns is re-seated on the right forearm. Electronic analysis indicates that these slapdash support units are also being used in company-sized C<sup>3</sup> networks. So far, these variants have only showed up in the sporadic border fighting with the Suns.

## Notable MechWarriors

**Chu-i David Hannsen:** Riding one of the rare fully functional BMD-12Ds in existence with the DCMS, *Chu-i* Hannsen distinguished himself during the Combine-Dominion War. A lone *Bombardier* in a company full of *O-Bakemonos* and *Archers*, Hannsen managed to coordinate their mass fire with scant intel onto several Bear positions during his tour with the Benjamin Regulars. His ability to drop such calculated fire helped turn the tide in several engagements. Though he claims more luck than skill, the fact remains that Hannsen is one of the best field support officers of the DCMS, garnering him a promotion to the First Genyosha.

# BMB-12D BOMBARDIER

Type: **Bombardier**

Technology Base: Inner Sphere

Tonnage: 65

Battle Value: 1,480

## Equipment

		Mass
Internal Structure:		6.5
Engine:	325 XL	12
Walking MP:	5	
Running MP:	8	
Jumping MP:	0	
Heat Sinks:	10	0
Gyro:		4
Cockpit:		3
Armor Factor:	200	12.5
	<i>Internal Structure</i>	<i>Armor Value</i>
Head	3	9
Center Torso	21	24
Center Torso (rear)		15
R/L Torso	15	20
R/L Torso (rear)		10
R/L Arm	10	20
R/L Leg	15	26

## Weapons

Weapons and Ammo	Location	Critical	Tonnage
LRM 20	LT	5	10
LRM 20	RT	5	10
Ammo (LRM) 12	RT	2	2
SRM 4	RA	1	2
Ammo (SRM) 25	RA	1	1
Anti-Missile System	CT	1	.5
Ammo (AMS) 12	CT	1	1
CASE	RT	1	.5

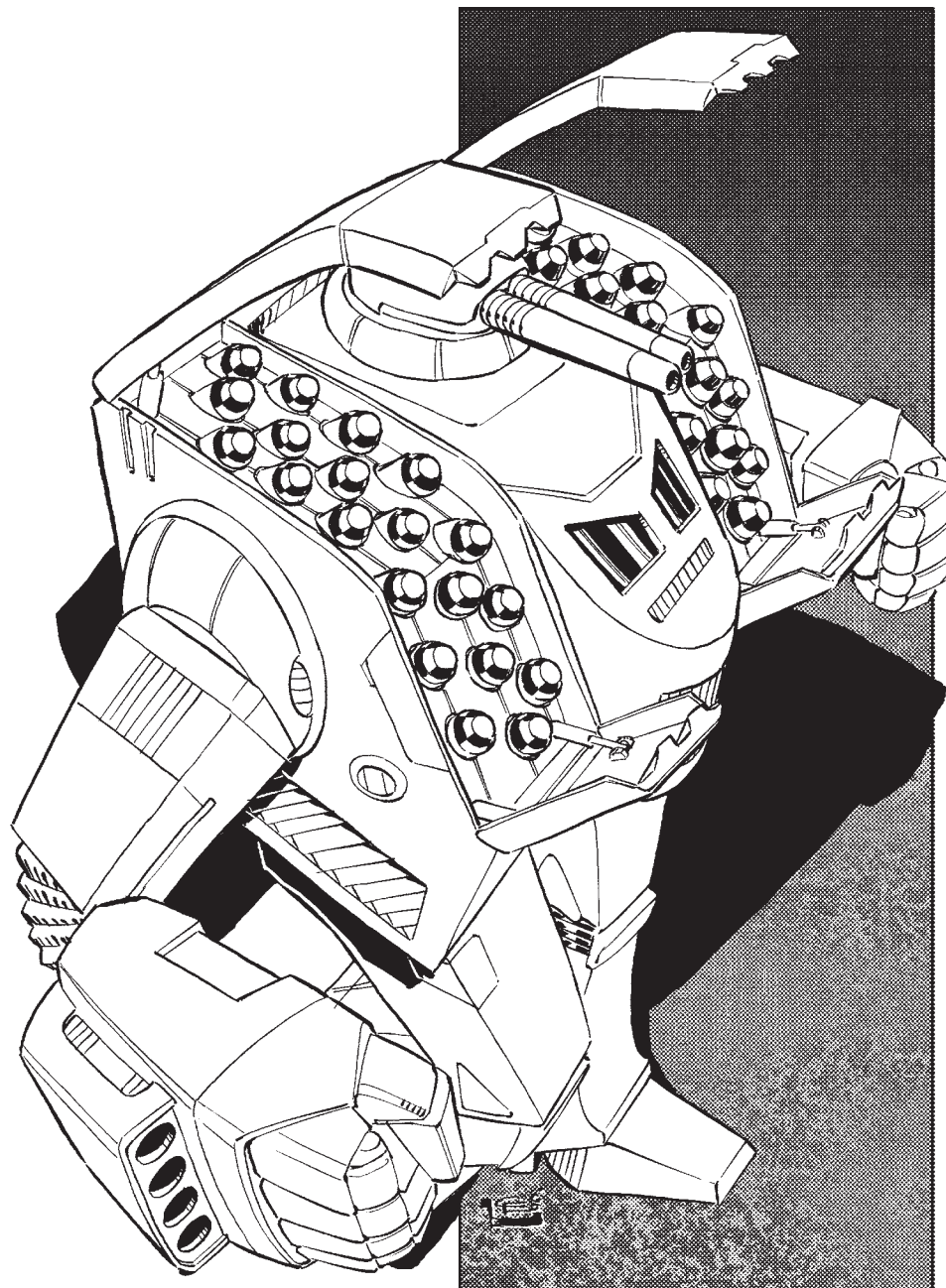

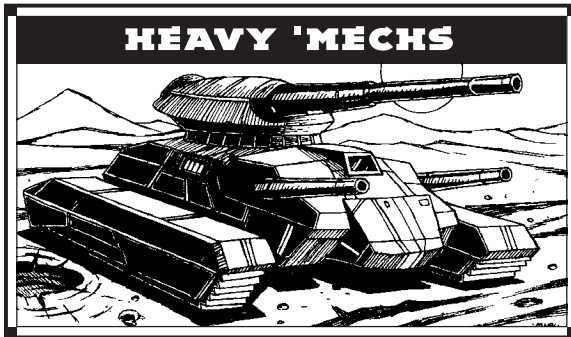

**Mass:** 65 tons

**Chassis:** SL Special

**Power Plant:** Magna 390 XL

**Cruising Speed:** 64 kph

**Maximum Speed:** 97 kph

**Jump Jets:** Chevron II

**Jump Capacity:** 180 meters

**Armor:** Fibrolyte Armorscale

**Armament:**

4 Averell Highpoint Medium Lasers

1 Deadeye-10 LRM Launcher

1 Buzzsaw Anti-Missile System

1 Dinotech Mark III Small Laser

**Manufacturer:** General Systems

**Primary Factory:** Caph (destroyed 2793)

**Communications System:** AR-12 Sheathed

Directional Beacon

**Targeting and Tracking System:** DLK Type Phased

Array Sensors

## Overview

The *Exterminator* was designed from the ground up as a hunter-killer unit. The original General Systems design—which went into active duty in 2630—did not have an impressive weapon's load-out, and its armor was only adequate for a 'Mech of its weight-class. What truly set the *Exterminator* apart was its cutting edge stealth systems. Until the Com Guard revealed itself in the 3030s, no *Exterminators* were known to have survived the First Succession War: Successor State armies trained specialized 'Mech lances to track down and annihilate these battlefield phantoms.

## Capabilities

The *Exterminator* mounts an LRM-10, four medium lasers, a small laser, and an anti-missile system. Its true strength lay in its various stealth technologies. Even today, with so much recovered lostech, the *Exterminator* is a marvel of technology, mounting a null signature system, phased array sensor system, sheathed directional communication beacon and Chameleon Light Polarization Shield. The protected communications systems, the heat-baffling capabilities of the null signature system and light-bending attributes of the polarization shield turned the *Exterminator* into a ghost on the battlefield.

## Deployment

The centuries since the final *Exterminators* were destroyed have hopelessly muddied the waters surrounding the details of this 'Mech. While ComStar and the Word of Blake field small numbers, few of the hyper-advanced technologies remain. Considering these represented the pinnacle of electronic-warfare development at the height of the Star League, such degradation is not unexpected.

While the Clans possess examples of the design, they have shown no inclination of using it—and by accounts stopped the research of stealth technologies during the Golden Century, believing that the use of such advances was dishonorable. The Inner Sphere was able to maintain several examples of the technology on the *Specter*-class BattleMech, though production was out of the question.

However, these technologies may not stay lost forever. In 3059, Dr. Gerhardt Marks, NAIS Research Coordinator, presented his dissertation to the Interstellar Symposium on Military Technology and alluded to research on the null signature system; work on the Chameleon Light Polarization Shield must surely follow.

## Variants

ComStar debuted the EXT-5E *Exterminator* in 3060, a rather extensive refit of this ancient design. Stripping it down to the bone, the 5E was rebuilt utilizing endo-steel. The jump jets were dumped in favor of MASC, while the AMS and LRM-10 were exchanged for improved Narc and C<sup>3</sup> systems. The addition of several tons of extra armor helped shore up one of the major flaws of the original design.

The EXT-5F appears to be a direct field refit of the 5E. Trading out the four extended-range medium la-

sers and iNarc for twin Light PPCs, an extended-range small laser and a multi-missile launcher-7 rack with two tons of ammunition, the 5E makes extensive use of the latest weaponry available.

Kallon Industries of Thermopolis recovered partial blueprints for the *Exterminator* in 3007 and attempted to use it to replace their aging *Wolverine*. Kallon replicated the overall design, though not the advanced technologies. Employing a 325 Vox standard fusion engine and single-strength heatsinks, the EXT-4A was mostly able to keep the original load-out except the AMS, which a machine gun replaced. The variant failed to live up to Kallon's expectations, as many MechWarriors found the *Wolverine* more effective. Construction was halted after two production runs.

## Notable MechWarriors

**Anderly Kerensky:** Despite his death centuries ago, Anderly Kerensky is arguably the most famous *Exterminator* pilot of all time. Though little is known about the younger brother of Nicholas Kerensky, his blood connection both to General Aleksandr Kerensky, last commander of the SLDF, and Nicholas Kerensky, founder of the Clans, has ensured a cult following for this seldom-understood man. A recently uncovered apocryphal writing from early in the Clan's Golden Century called Anderly "Nicholas' Conscience;" the author is unknown, and the veracity of the document is unverifiable at this time. In the end, all that is really known and remembered among the Clans is that Anderly died at the end of Operation Klondike as the nascent Clans conquered the civil war-ridden Pentagon Worlds. While Spheroid-cult members will tell you the Clans had him murdered, we may never know. But his name, and the 'Mech he piloted, will likely echo for ages to come.

**Precentor XI Dave Baughman:** Commander of the Twenty-eighth Division, Precentor Baughman—supported by the Forty-fifth Shadow Division—led an assault against Wolf's Dragoons Delta Regiment on Buckminster in 3070. However, the Dragoons savaged the Word of Blake forces, killing Precentor Tunrida, commander of the Shadow Division. Blaming Precentor Tunrida for the debacle, Precentor Baughman took command of the entire assault force and executed a brilliant fighting withdrawal off world.



# EXT-4D EXTERMINATOR

Type: **Exterminator**

Technology Base: Inner Sphere

Tonnage: 65

Battle Value: 1,385

## Equipment

		<b>Mass</b>
Internal Structure:		6.5
Engine:	390 XL	23
Walking MP:	6	
Running MP:	9	
Jumping MP:	6	
Heat Sinks:	10 [20]	0
Gyro:		4
Cockpit:		3
Armor Factor:	168	10.5

	<i>Internal Structure</i>	<i>Armor Value</i>
Head	3	9
Center Torso	21	21
Center Torso (rear)		8
R/L Torso	15	20
R/L Torso (rear)		8
R/L Arm	10	18
R/L Leg	15	19

## Weapons and Ammo

	<b>Location</b>	<b>Critical</b>	<b>Tonnage</b>
LRM 10	LT	2	5
Ammo (LRM) 12	CT	1	1
2 Medium Lasers	RA	2	2
2 Medium Lasers	LA	2	2
Small Laser	H	1	.5
Anti-Missile System	RT	1	.5
Ammo (AMS) 12	RT	1	.5
Jump Jets	RT	3	3
Jump Jets	LT	3	3

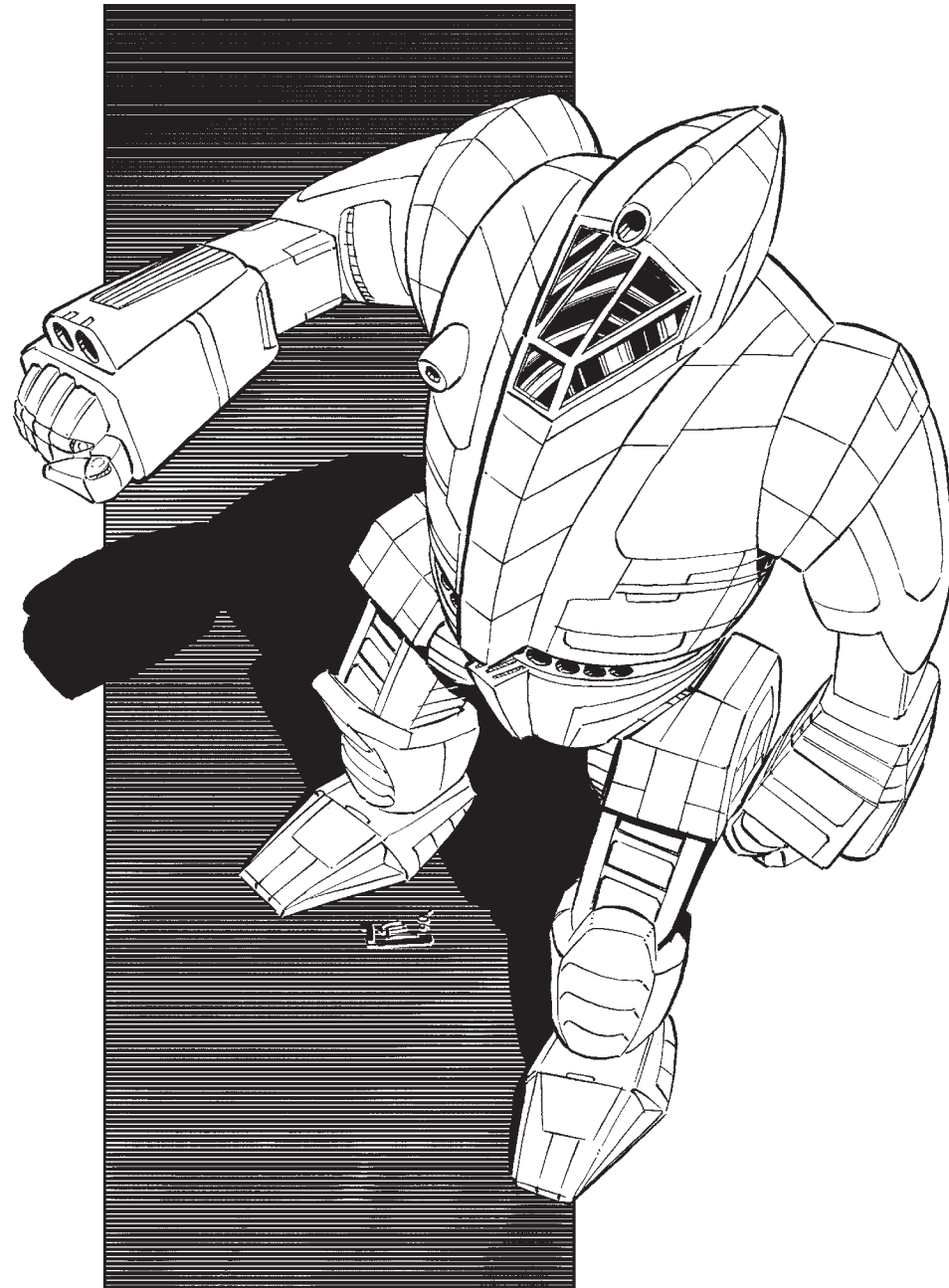

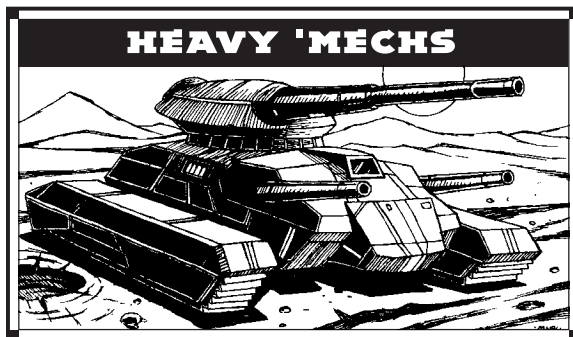

**Mass:** 70 tons

**Chassis:** Crucis-I Endo Steel

**Power Plant:** VOX 280

**Cruising Speed:** 43 kph

**Maximum Speed:** 64 kph

**Jump Jets:** Anderson 398

**Jump Capacity:** 120 meters

**Armor:** Ulston Prime with CASE

**Armament:**

1 Sunglow Large Laser

4 ExoStar II Medium Lasers

1 Coventry-6 SRM Launcher

**Manufacturer:** Newhart Industries

**Primary Factory:** New Earth (destroyed 2776)

**Communications System:** StarLink 955G

**Targeting and Tracking System:** Pulsar Tri-X

## Overview

First built in 2499, the *Guillotine* became a favored attack unit for Terran Hegemony forces, setting a standard against which later machines would strive to compete. Known for their excellent mobility, armor, and a dependable mix of weapons, *Guillotines* often anchored other fast attack units such as the *Griffin* and the *Thunderbolt*, providing heavy support fire for entire companies. With the rise of the Star League, the *Guillotine* would become a mainstay of almost every SLDF regiment, though heavier and more sophisticated designs eventually relegated the machine to the role of a heavy raider.

## Capabilities

Despite using a weightier standard engine, the *Guillotine* attains a good land speed for a seventy-ton BattleMech and boasts the added benefit of jump jets to overcome more restrictive terrain. Its reliance on common energy weapons assures that its firepower is both consistent in long actions and easy to maintain in the aftermath. Though some glitches persisted throughout this 'Mech's Star League career—particularly with the Sunglow large laser power feeds and an erratic glitch in the Coventry-6 SRM system that served as a backup weapon—the *Guillotine* proved to be a survivor of the highest order, which is how so many of them lived on past the fall of the League.

## Deployment

With the departure of Kerensky's forces and the collapse of the League, many of the SLDF *Guillotines* were scattered among the Great Houses. ComStar acquired the largest stockpile after they raided New Earth in 2788, and seized—among other supplies—close to a battalion of *Guillotines* from a former Newhart Industries warehouse. The remaining *Guillotines* eventually began to decline as the Succession Wars dragged on, creating the 4L downgrade that persisted through the later conflicts until the recovery of the Gray Death memory core enabled producers in the Inner Sphere to resurrect this venerable machine. Indeed, Irian Technologies' 5M model—produced from a refurbished plant that once manufactured the original model under a Newhart license—would come to surpass its Star League ancestor.

## Variants

As technology declined in the early Succession Wars, the *Guillotines* left in the Successor State armies found themselves downgraded to ease their maintenance needs. A standard internal structure replaced the out-of-production materials of the Crucis I endo steel, while CASE and some heat sinks were lost to offset the weight increase. While these changes made the 4L model run hotter, they affected the BattleMech's performance only slightly, and many survived to the present day.

House Marik's 5M model, which emerged in the late 3040s, not only restored the capabilities of the original 3N, but improved upon them by trading the quirky Sunglow large laser with an improved Sunbeam ER model. An even more radical design appeared on the eve of the FedCom Civil War when the Federated Suns debuted its 8D variant, with its targeting computer-assisted suite of ER lasers, backed by a Streak-6 launcher and cooled by double heat sinks.

Two new variants have appeared in the wake of the Jihad, both apparently produced by Irian Technologies for the Word of Blake. The first, the GLT-6WB, uses a small cockpit, compact gyro, ferro-fibrous armor and double heat sinks to enhance its performance and free up tonnage for a quartet of ER medium lasers and a left arm heavy PPC, while the centerline SRM-6 has been replaced with a larger LRM-15 rack. The 6WB2 model is even more radical, combining a compact gyro, extralight engine, double heat sinks and improved jump jets to make room for twin Light PPCs, a light Gauss rifle, an Artemis-enhanced LRM-5, and twin ER medium lasers. Both of these Blakist variants also feature an improved C<sup>3</sup> system for maximum effectiveness, but the WB2's 180-meter jump distance often comes as the rudest surprise of the two.

## Notable MechWarriors

**Precentor Sariel:** An "Omega" Manei Domini and apparent commander of the Word of Blake's elite Fortieth Shadow Division, Sariel—a twisted mass of flesh and cybernetic implants—personally led the conquest of Hesperus II in 3070 from the cockpit of a prototype 6WB model. Still reportedly on-world while his Division (nicknamed "Sariel's Conquerors") plunders the factory output for replacement machines, Sariel has made sport of hunting down rebel forces in the hinterlands of barren Hesperus II, particularly along the northern edges of the planet's equatorial jungles.

# GLT-3N GUILLOTINE

Type: **Guillotine**

Technology Base: Inner Sphere

Tonnage: 70

Battle Value: 1,418

## Equipment

		Mass
Internal Structure:	Endo Steel	3.5
Engine:	280	16
Walking MP:	4	
Running MP:	6	
Jumping MP:	4	
Heat Sinks:	25	15
Gyro:		3
Cockpit:		3
Armor Factor:	192	12

	Internal Structure	Armor Value
Head	3	9
Center Torso	22	27
Center Torso (rear)		12
R/L Torso	15	22
R/L Torso (rear)		8
R/L Arm	11	20
R/L Leg	15	22

## Weapons and Ammo

	Location	Critical	Tonnage
Large Laser	LA	2	5
Medium Laser	LT	1	1
SRM 6	CT	2	3
Ammo (SRM) 15	RT	1	1
CASE	RT	1	.5
Medium Laser	RT	1	1
2 Medium Lasers	RA	2	2
Jump Jet	LT	1	1
Jump Jet	LL	1	1
Jump Jet	RT	1	1
Jump Jet	RL	1	1

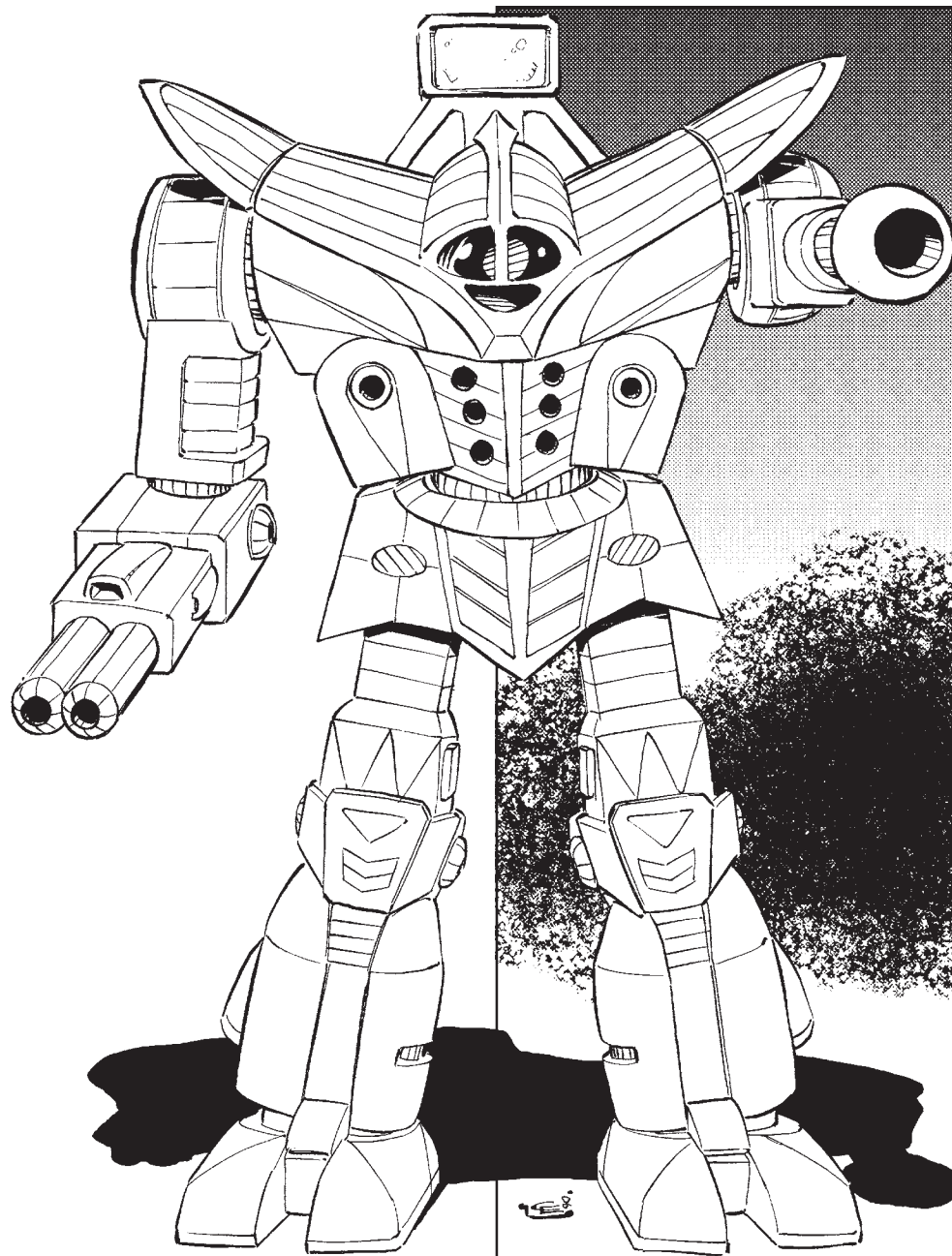

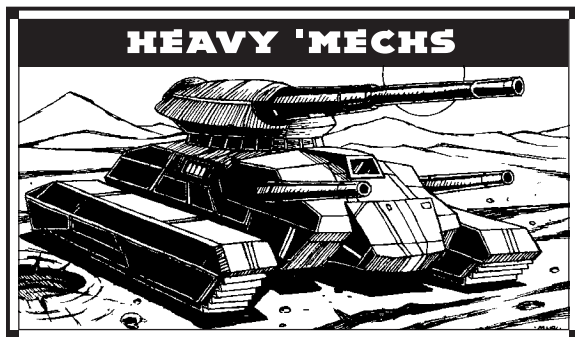

**Mass:** 75 tons  
**Chassis:** Technicon 1L Endo Steel  
**Power Plant:** Vlar 300  
**Cruising Speed:** 43 kph  
**Maximum Speed:** 64 kph  
**Jump Jets:** None  
**Jump Capacity:** None  
**Armor:** Valiant Lamellor  
**Armament:**  
1 Magna Hellstar II PPC  
2 Tronel III Large Lasers  
4 Tronel II Medium Lasers  
1 Tronel I Small Laser  
**Manufacturer:** Kong Interstellar Corporation  
**Primary Factory:** Connaught  
**Communications System:** TransComm Alpha  
**Targeting and Tracking System:** TransComm Beta  
with Beagle Active Probe

## Overview

Introduced during the Reunification War, the *Black Knight* has been incredibly successful. In it, Kong Interstellar Corporation came close to the 'Mech designer's Holy Grail of creating the ultimate heavy BattleMech.

After the fall of the Star League, KIC continued production until their manufacturing plants were heavily damaged during the First Succession War. Reduced to manufacturing spares and performing maintenance, KIC's fortunes have finally recovered, with the company rebuilding their BattleMech production plant in 3065.

## Capabilities

Mounting heavy armor protection on an endo-steel chassis, the *Black Knight's* external styling resembles

a giant suit of medieval armor. An impressive array of energy weapons make the 'Mech a threat few can ignore. However, the high number of energy weapons makes heat buildup a significant problem, even with twenty heat sinks. A Beagle Active Probe allows the *Black Knight* to defeat all but the best ECM. In addition, the system is tied into the weapons system, allowing the Beagle's scanner to analyze nearby objects by riding a low-power laser pulse generated by the Magna small laser.

Over the centuries the *Black Knight* has established a reputation as an extremely tough opponent. Survivors of encounters with the design tell tales of having to literally dismember their foe to halt its inexorable advance.

## Deployment

Ready in time for the campaign against the Taurian Concordat, the *Black Knight* saw battle for the first time in 2578 on Ridgebrook. The Third Heavy Assault Regiment (The Pythons) used their new heavy 'Mechs to storm the Fifteenth Fortress Battalion's headquarters. During the fighting, company commanders found that the sophisticated electronics made the *Black Knight* an excellent command 'Mech. Following its successful debut, the SLDF's First Corps deployed the design extensively.

Like the SLDF, ComStar found the *Black Knight* to be an ideal command vehicle in Level II and Level III formations during the fighting on Tukayyid.

The *Black Knight* can also be found in the ranks of the Clan's solahma units.

## Variants

Reserved for SLDF Royal BattleMech regiments, the BL-6b-KNT was introduced in 2751. Fitted with sixteen double efficiently heat sinks, weaponry was upgraded with a Kinslaughter ER PPC and two Raker-X large pulse lasers.

ComStar modified a number of *Black Knights* in preparation for fighting the Clans. The BL-8-KNT mounts an XL engine and fifteen double heat sinks. A Magna Sunspot ER PPC gives this "Clanbuster" extended reach, and the medium lasers have been swapped out for more accurate Aberdovey pulse lasers. The small laser and Beagle system were replaced with a center-torso mounted Aberdovey large pulse laser and

additional armor. With the intent of capitalizing on the Clan's disdain for physical attacks, a five ton hatchet was added to the left arm.

Robinson Standard BattleWorks secured a license from the KIC to produce the *Black Knight* in 3063. Using high quality lasers imported from Lushann Industries in the Outworlds Alliance, RSB developed the BL-12-KNT variant. Replacing the PPC and the medium lasers with extended-range weapons, this variant adds a sophisticated targeting computer in place of the small laser and Beagle. Even with sixteen double heat sinks, MechWarriors must watch their heat levels.

## Notable MechWarriors

**Captain Wilbur Frews:** Champion of the 124th Royal Heavy Assault Regiment from 2711 to 2718, Captain Frews was probably the Gunslinger Program's strangest graduate. Convinced it would give him an edge, Frews immersed himself in the mythos of the Wild West's gunslingers. He even stopped wearing his uniform, instead dressing like gunmen of the ancient American West. Though never defeated in seven years of dueling, Frews' mental stability deteriorated until his commanding officers finally sent him back to Terra for rest and recovery.

**Leftenant David McKinnon:** Cousin of Ross McKinnon, commander of the legendary McKinnon's Raiders (also known as the Fox's Teeth), David McKinnon is considered to be something of a loose cannon. Though a skilled warrior and cunning strategist, McKinnon has a tendency to act without waiting for orders. That he is invariably right only serves to irritate McKinnon's superiors all the more, and has kept him a mere Leftenant in the Twentieth Avalon Hussars.

Stranded with his lance on Beid in 3070, McKinnon repelled Word of Blake raiders with an ad-hoc force of local militia and walking wounded evacuated from the Capellan front. With the AFFS High Command paralyzed by the Blakist's tactics, McKinnon has characteristically taken it upon himself to defend Beid and the surrounding worlds. Now piloting a captured BL-12-KNT, McKinnon and his growing force of irregulars are striking back at the Word of Blake.

# BL-6-KNT BLACK KNIGHT

Type: **Black Knight**

Technology Base: Inner Sphere

Tonnage: 75

Battle Value: 1,550

## Equipment

		Mass
Internal Structure:	Endo Steel	4
Engine:	300	19
Walking MP:	4	
Running MP:	6	
Jumping MP:	0	
Heat Sinks:	20	10
Gyro:		3
Cockpit:		3
Armor Factor:	208	13

	Internal Structure	Armor Value
Head	3	9
Center Torso	23	29
Center Torso (rear)		10
R/L Torso	16	24
R/L Torso (rear)		8
R/L Arm	12	24
R/L Leg	16	24

## Weapons and Ammo

	Location	Critical	Tonnage
PPC	RA	3	7
Large Laser	RT	2	5
Large Laser	LT	2	5
Medium Laser	RT	1	1
Medium Laser	LT	1	1
Medium Laser	RA	1	1
Medium Laser	LA	1	1
Small Laser	H	1	1
Beagle Active Probe	CT	2	1.5

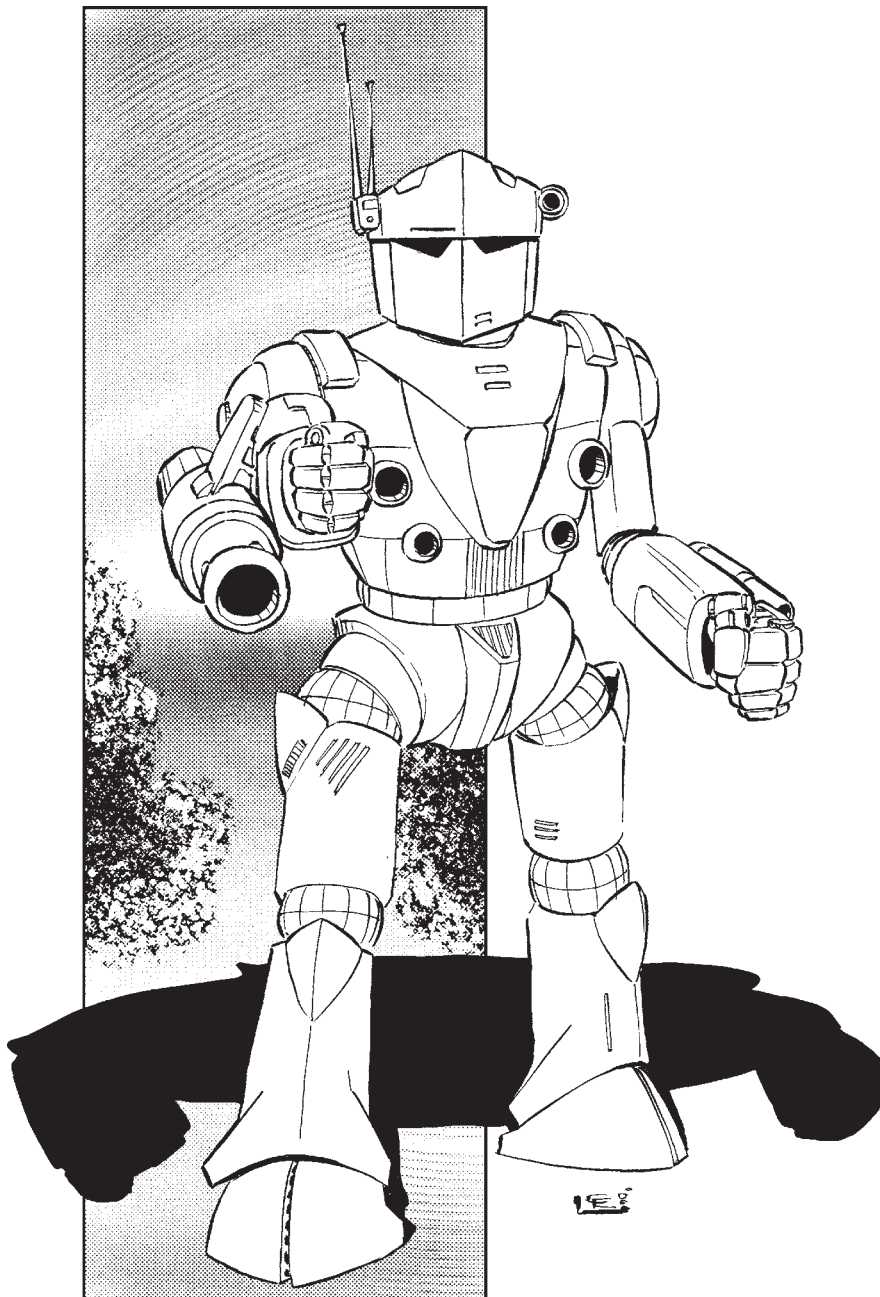

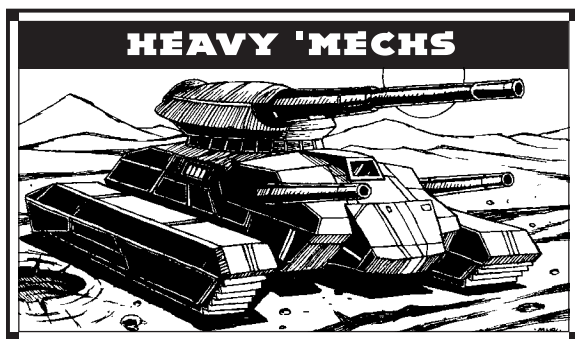

**Mass:** 75 tons

**Chassis:** FLS/HV-1

**Power Plant:** GM 375 XL

**Cruising Speed:** 54 kph

**Maximum Speed:** 86 kph

**Jump Jets:** None

**Jump Capacity:** None

**Armor:** Kemplar 5000

**Armament:**

3 Selitex Radionic (Defiance Thunderbolt A5M)  
Large Lasers

5 Ichiba 3000 (Defiance B3M) Medium Lasers

1 Buzzsaw Anti-Missile System

1 Zippo Mark X (Coventry Volcano)

Anti-Personnel Flamer

**Manufacturer:** Renault-Prime (Defiance Industries)

**Primary Factory:** Wasat (Hesperus II)

**Communications System:** Duotek 195

(Faust/Calliope FM-4)

**Targeting and Tracking System:** Faust/Shinji AT/TS  
(TharHes Ares-7)

## Overview

A heavy and dedicated laser boat built for combat far from friendly supply lines, the FLS-8K *Flashman* entered production in 2701 and quickly became a mainstay of the Terran Hegemony's armed forces and, later, the SLDF. The unquestionable effectiveness of this design made it a favored target in the post-Star League era, culminating in the utter destruction of the Renault-Prime factory complexes that produced it in 2796, but not before Defiance Industries of Hesperus II managed

to obtain the design specs and license to produce its own variant. This fortuitous event saved the *Flashman* from utter extinction, permitting its return (albeit in a downgraded variant) for much of the Succession Wars. The recovery of the Gray Death memory core brought this machine back in its full glory, with Defiance once more churning out Star League-quality FLS-8Ks by the mid-3050s.

## Capabilities

Originally powered by an extra-light engine, the *Flashman* was fast for its size back in its heyday. While it lacked jump jets, this 'Mech's land speed and double-strength heat sinks enabled it to keep up with most contemporary medium and heavy designs, even while pouring a wall of laser-fire into the enemy. Backing up its formidable array of large and medium lasers with a head-mounted flamer for anti-personnel work (and as a psychological weapon), the *Flashman* also boasted an anti-missile system to weather incoming enemy fire.

## Deployment

Because of Defiance Industries' foresight in acquiring the *Flashman* specs before their original lines were destroyed, the Lyran Commonwealth became the second-largest user of this BattleMech through the Succession Wars (after ComStar). Nevertheless, with the downgraded efficiency of their FLS-7K model, these machines failed to stand out over time and were ultimately relegated to a second-line role as a result. The technology renaissance of the 3030s and 3040s allowed Defiance to work toward the reborn 8K model, but it was not until the 3050s that these 'Mechs truly returned to their former glory.

## Variants

Defiance Industries' downgraded 7K model is no longer in production, having been replaced by the reintroduction of the 8K design (which differs from its Terran Hegemony version only in the name brands of the weapons and components). The 7K variant—which features a slower standard engine, standard heat sinks, and deleted both a large laser and the anti-missile system to retain the rest of its capabilities—may still be

encountered from time to time, however. Defiance also produced a limited-production variant for ComStar in early 3060s. The 9C upgrades the large lasers to extended-range models, replaces the forward mounted medium lasers with pulse models, and adds a C<sup>3</sup>i computer. To free up the room for these modifications, it utilizes an endo-steel chassis and removes the flamer and AMS.

In addition, there are three much newer *Flashman* variants in production today. The Draconis Combine's FLS-C, for instance, takes the downgraded ComStar-provided models and installs a C<sup>3</sup> system to enhance its battlefield accuracy. The two newer designs, the 9B and 9M, both entered production only recently from the Blakist-controlled Defiance Industries factory lines. Both of these variants feature light engines, light ferro-fibrous armor, and double heat sinks. The 9B model used by the Word employs two ER large lasers, backed up by a mix of ER and pulse medium lasers enhanced by a C<sup>3</sup>i system—gaining space for this configuration through the use of a compact gyro and cockpit. The 9M, apparently intended for the Marik Commonwealth forces loyal to the Word, uses a standard gyro and cockpit and trades its firepower for twin heavy PPCs and a combination of standard and pulse lasers.

## Notable MechWarriors

**Lt. Colonel Damon “the Indestructible” Kirkpatrick:**

The commander of the Kirkpatrick's Invaders mercenary battalion, Damon Kirkpatrick earned the moniker of “Indestructible” for his dubious habit of losing 'Mech after 'Mech in heroic battle while suffering nary a scratch himself. During the Kaumberg Conflict of 3063, Kirkpatrick's ride—an 8K model *Flashman*—continued this fine tradition when its fusion reactor suffered catastrophic damage during a desperate battle inside the capital city of Stuttgart. To Kirkpatrick's credit, his *Flashman*, “Demonfire,” accounted for six LeSat BattleMech kills in that action, including a pristine *Caesar* caught in Kirkpatrick's final blaze of glory. As usual, Kirkpatrick himself escaped his emergency ejection with little more than a black eye and a skinned elbow.

# FLS-8K FLASHMAN

Type: **Flashman**

Technology Base: Inner Sphere

Tonnage: 75

Battle Value: 1,779

## Equipment

		Mass
Internal Structure:		7.5
Engine:	375 XL	19.5
Walking MP:	5	
Running MP:	8	
Jumping MP:	0	
Heat Sinks:	15 [30]	5
Gyro:		4
Cockpit:		3
Armor Factor:	216	13.5

	Internal Structure	Armor Value
Head	3	9
Center Torso	23	25
Center Torso (rear)		16
R/L Torso	16	22
R/L Torso (rear)		10
R/L Arm	12	24
R/L Leg	16	27

## Weapons

and Ammo	Location	Critical	Tonnage
Large Laser	LA	2	5
Medium Laser	LA	1	1
Medium Laser	LT	1	1
Medium Laser	LT (R)	1	1
Large Laser	CT	2	5
Flamer	H	1	1
Large Laser	RA	2	5
Medium Laser	RA	1	1
Medium Laser	RT	1	1
Anti-Missile System	RT	1	.5
Ammo (AMS) 12	RT	1	1

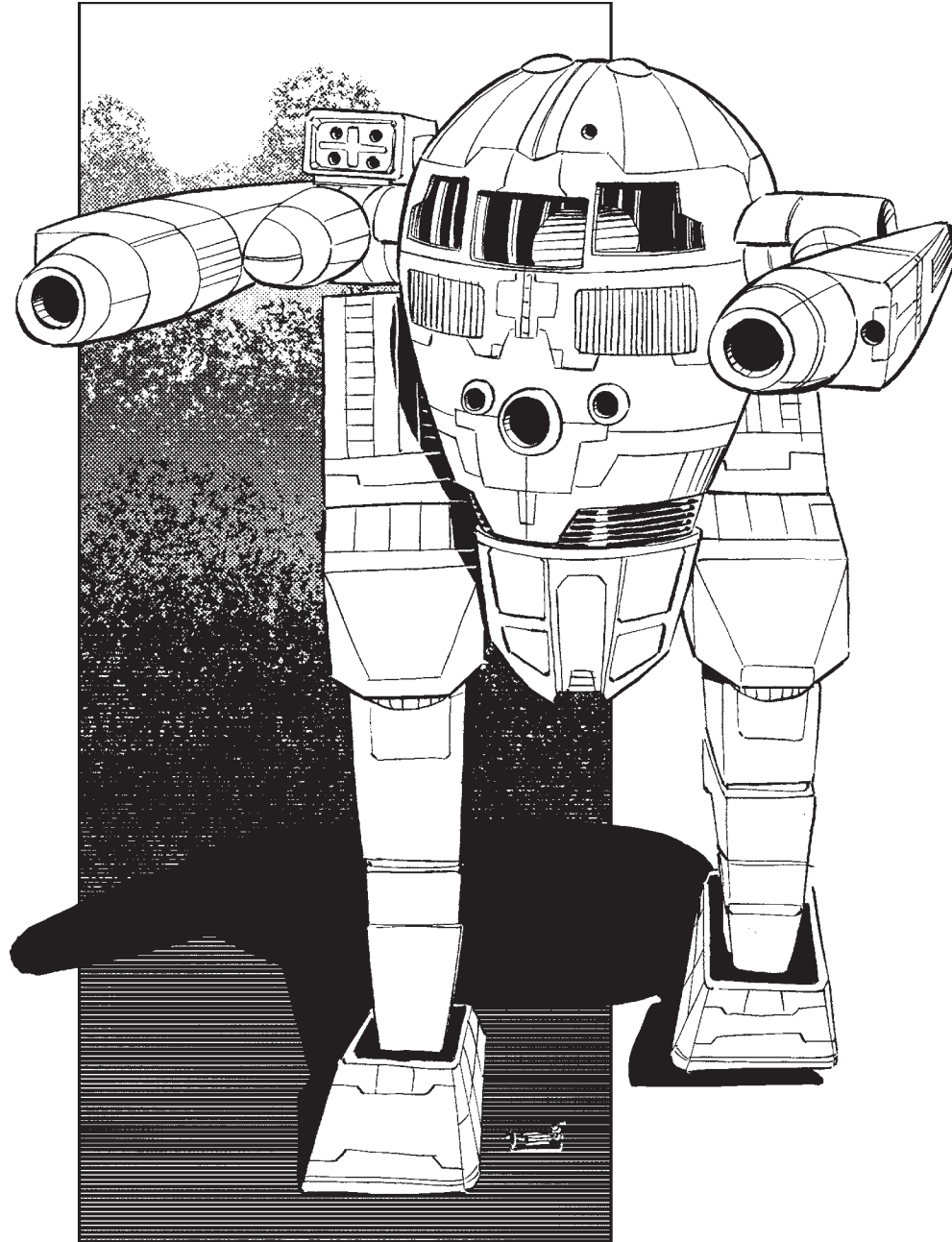

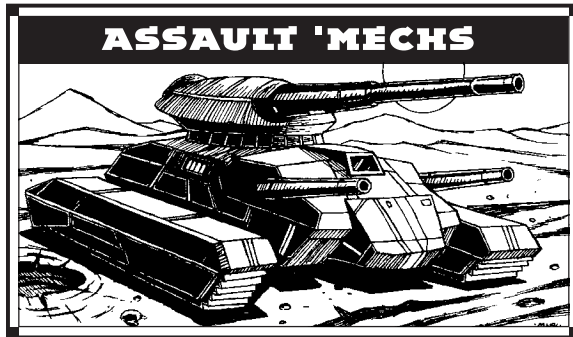

**Mass:** 80 tons

**Chassis:** Earthwerks VOL Endo Steel

**Power Plant:** Pitban 320

**Cruising Speed:** 43 kph

**Maximum Speed:** 64 kph

**Jump Jets:** None

**Jump Capacity:** None

**Armor:** Mitchell Argon with CASE

**Armament:**

2 Tiegart PPCs

2 Bical SRM-6 Missile Racks

**Manufacturer:** Maltex Corporation,  
Earthwerks Incorporated

**Primary Factory:** Errai, Keystone

**Communications System:** Colmax 90

**Targeting and Tracking System:** TharHes Ares-5

## Overview

In 2572, the Star League Defense Forces were still but a dream, but the newly formed Star League knew that it would have to prepare for war. At the same time, First Lord Ian Cameron wanted his armed forces to be the most advanced and best-equipped in existence. With that in mind that the Star League contracted the Maltex Corporation, which was already working on designing a competitor to the popular and long-serving *Warhammer*. The resulting *Thug* proved not only a worthy successor, but it remains one of the hardest BattleMechs ever produced.

Despite the destruction of Maltex's production facilities in 2835—reducing Maltex to nothing more than a licensing-house—the design survived. Though the

degradation of technology forced a re-working of the 'Mech, Earthwerks-licensed *Thugs* continued to be a feared sight on the battlefields of the Succession Wars, albeit in limited numbers.

## Capabilities

At eighty tons, the *Thug* highlights the best qualities of the venerable *Warhammer* while effectively eliminating its drawbacks. Ten tons heavier than its predecessor and utilizing endo-steel, the *Thug* has plenty of spare mass to mount the maximum armor protection possible and a powerful arsenal of weapons. Maltex's engineers retained the tried-and-true arm-mounted PPCs made classic by the *Warhammer*, though they added hand actuators that MechWarriors had long clamored for. Those engineers further eliminated the *Warhammer's* tertiary weaponry in order to mount a second SRM-6 launcher and CASE-protected ammunition bins.

Detractors (and competitors) throughout the years have pointed to the *Thug's* apparent weaknesses, such as a weak damage potential when compared to modern designs, or the fact that it is “over-heat sinked” as proof positive it is an ineffective BattleMech. On the other hand, not a single *Thug* pilot—or opponent—has ever criticized these flaws. It is no mistake that the *Thug* has been known for the last 500 years as the definitive “zombie 'Mech”.

## Deployment

Owing to its hearty constitution, a relatively small number of *Thugs* have suffered complete destruction throughout the years, though at the same time its endo-steel construction long prevented repair of most of the Star League-era samples that were in service to the Successor States. Both ComStar and the Word of Blake field large numbers of *Thugs*, which form the backbone of their heavy and assault 'Mech formations. The design appears in moderate numbers with the Free Worlds League as well, as a result of their ties with the WoB and Earthwerks' continued production of the 'Mech.

After the formation of the new Star League, ComStar provided the capital for Maltex to partially reconstruct its facilities, allowing production of the

*Thug* once again. The production runs have been split between the Com Guards, the reforming SLDF, DCMS, and AFFS.

## Variants

The *Thug-12E* is both a field upgrade and a new model currently built by Maltex and Earthwerks, primarily serving ComStar but also used in smaller numbers by the Word of Blake. It upgrades the standard PPCs to ER models, stripping out a heat sink and one ton of CASE-protected SRM ammo to make room for a C<sup>3</sup>i system. Maltex also builds the 12K, which swaps the C<sup>3</sup>i out for a standard Combine C<sup>3</sup> module and a Guardian ECM suite.

In the last few years, Maltex took the concept of the *Thug* to the extreme, stripping out the missile racks and ER PPCs and utilizing an extra-light engine to make room for three newly developed heavy PPCs and a pair of pulse lasers, all tied through a C<sup>3</sup>i computer.

Earthwerks' downgraded THG-10E model employed a standard chassis and single heat sinks, and replaced the SRM-6s with a pair of SRM-4s and a single ton of ammunition. The design also reduced the armor protection slightly and did not include CASE.

## Notable MechWarriors

**MechWarrior Shaun:** Shaun was a Dispossessed MechWarrior stuck on Galatea, watching the Jihad-induced hysteria from the sidelines until fate delivered him an opportunity he could not pass up—a *Thug* sprawled out on the ground, its pilot killed by a freak cockpit breach. Hatching a plot with three other former MechWarriors he had been squatting with, he carried their “dead” bodies, dressed in tattered Blakist uniforms, into the Word of Blake camp. There, they stole three more 'Mechs and ravaged the camp before escaping. “The Dead” remain a presence on the world, heroes (and targets) to the thousands of Dispossessed still fighting to make names for themselves, one way or another.



# THG-11E THUG

Type: **Thug**

Technology Base: Inner Sphere

Tonnage: 80

Battle Value: 1,640

## Equipment

		Mass
Internal Structure:	Endo Steel	4
Engine:	320	22.5
Walking MP:	4	
Running MP:	6	
Jumping MP:	0	
Heat Sinks:	18 [36]	8
Gyro:		4
Cockpit:		3
Armor Factor:	247	15.5

	Internal Structure	Armor Value
Head	3	9
Center Torso	25	34
Center Torso (rear)		16
R/L Torso	17	25
R/L Torso (rear)		9
R/L Arm	13	26
R/L Leg	17	34

## Weapons and Ammo

	Location	Critical	Tonnage
PPC	RA	3	7
PPC	LA	3	7
SRM 6	RT	2	3
Ammo (SRM) 15	RT	1	1
CASE	RT	1	.5
SRM 6	LT	2	3
Ammo (SRM) 15	LT	1	1
CASE	LT	1	.5

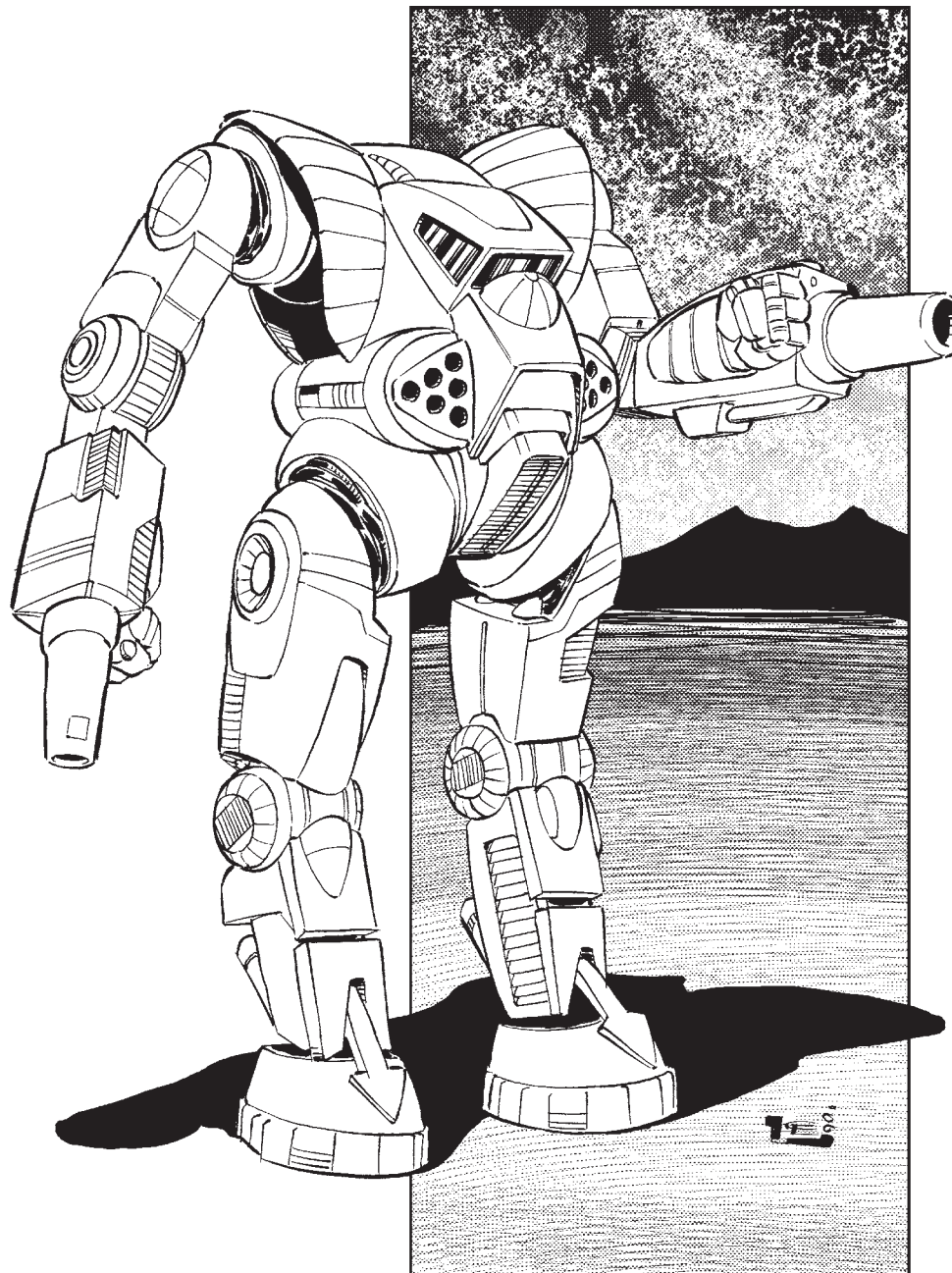

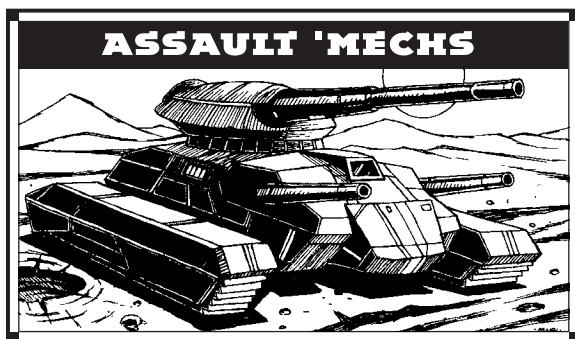

**Mass:** 85 tons

**Chassis:** Geometric 530 Hard Core

**Power Plant:** Strand 255D

**Cruising Speed:** 32 kph

**Maximum Speed:** 54 kph

**Jump Jets:** Geotec 300

**Jump Capacity:** 90 meters

**Armor:** CarboStrand 30 Weight AS

**Armament:**

2 Blankenburg 25 Extended-Range Large Lasers

2 Holly-6 SRM Launchers

1 Blankenburg LB 10-X Autocannon

2 Dodd Small Lasers

**Manufacturer:** Blankenburg Technologies

**Primary Factory:** Terra

**Communications System:** GRPNTR Groundpainter 5

**Targeting and Tracking System:** Scope 30 RNDST

## Overview

Originally entering limited production in 2735, the *Crockett* was designed as an SLDF trainer assault BattleMech. The *Crockett* far surpassed its designers' intent however, and proved to be a highly successful assault 'Mech in its own right. In fact, the design was so effective on the frontlines that most were stripped from their training programs. The *Crockett* all but disappeared during the conflagrations of the Succession Wars, except for those hoarded by ComStar.

During the 3030s the design had a rebirth of sorts, as numerous stripped-down versions of the 'Mechs were given to the DCMS as part of Primus Myndo Waterly's deal with then-*Kanrei* Theodore Kurita. To

deflect away any speculation of the 'Mechs origins, the "new" design was renamed the *Katana*.

## Capabilities

Although designed as a training platform, Blankenburg took seriously the Quartermaster Command's request that the new trainer should itself be battleworthy. Its wide mix of weapons and the extra mobility of jump jets all add to the machine's training potential, while simplified controls make the *Crockett* ideal for green MechWarriors.

Two Blankenburg 25 extended-range large lasers provide the *Crockett's* punch at distance, and are backed by a Blankenburg LB 10-X autocannon. Short-range firepower is supplied by a pair of ever-reliable Holly SRM-6 launchers, and two Dodd small lasers round out the design.

The *Crockett's* signature maneuver in combat is to whittle down an opponent's armor at distance using its long-range weaponry. As the range closes, the *Crockett* uses its jump jets to prevent it from being accurately targeted and then jumps behind its enemy. This forces the target to either turn and face the *Crockett*, thus exposing its rear to the *Crockett's* lancemates, or let the *Crockett* have free rein to target their opponent's weaker back armor.

## Deployment

Once widely deployed across the Inner Sphere, the *Crockett* is primarily fielded by ComStar and the Word of Blake and is occasionally seen in Clan second-line forces. The design saw heavy action on Tukayyid and during Operation Odyssey.

By far the largest contingent of ComStar troops on Terra to survive the initial Word assaults was the Sandhurst training regiment. Despite their commander's assassination and the bombing of their barracks, the survivors made an orderly withdrawal from the college. Knowing the London DropPort was in enemy hands, the cadets withdrew west towards Wales hoping to find transport at a seaport or to use one of the trans-Atlantic tunnels to escape to Ireland or North America. Harried all the way by Word forces, ComStar *Crocketts* made life difficult for the WoB troops, luring them into ambush after ambush. The remnants of the Sandhurst regiment

were eventually crushed, though a number of cadets are believed to have survived the battle.

## Variants

As part of ComStar's massive rearmament drive in the 3050s, former Precentor Martial Anastasius Focht ordered the re-opening of Blankenburg's 'Mech division and new 5003-1 *Crocketts* began striding off the production lines in early 3054.

Following the loss of Terra, ComStar looked to expand the Free Rasalhague Republic's BattleMech facilities to produce 'Mechs for the Com Guards. With ComStar funding the expansion, Grumium Creations began to produce the 5003-3 variant in 3062, and the 5004-1 a year later. Change this last sentence to: Minor upgrades, the 5003-3 exchanges armor for CASE in the right torso, while the 5004-1 changes the small lasers for ER models, drops the SRM-6s to 4s and removes a ton of LB 10-X ammunition to add a C<sup>3</sup>i suite.

Sketchy details suggest the Word has also fielded an advanced *Crockett* of their own, provisionally dubbed the 5005-1. Known to be employing a small cockpit and a C<sup>3</sup>i suite, this variant is believed to be utilizing a light engine and improved jump jets—something that will come as rude shock to many.

## Notable MechWarriors

**Fer de Lance:** One of the greatest MechWarriors that never existed, *Fer de Lance* was the star of a Sphere-wide smash holovid show from J.F. Madan Productions of El Giza. Debuting over two hundred and fifty years prior to the Immortal Warrior, the mysterious female warrior piloting a boldly painted golden *Crockett* was known as a champion of the downtrodden and defender of the weak.

**Cadet Epsilon II Duncan Fergusson:** A member of Acid Rain II-Alpha—part of the Sandhurst training regiment—Cadet Fergusson piloted one of the *Crocketts* that gave the Word's forces a run for their money during his regiment's retreat. Blown out of his 'Mech in the final battle outside Lampeter, Fergusson is believed to have been killed, though his body was never found.

# CRK-5003-1 CROCKETT

Type: **Crockett**

Technology Base: Inner Sphere

Tonnage: 85

Battle Value: 1,923

## Equipment

		<b>Mass</b>
Internal Structure:		8.5
Engine:	255	13
Walking MP:	3	
Running MP:	5	
Jumping MP:	3	
Heat Sinks:	15 [30]	5
Gyro:		3
Cockpit:		3
Armor Factor:	263	16.5

	<i>Internal Structure</i>	<i>Armor Value</i>
Head	3	9
Center Torso	27	35
Center Torso (rear)		19
R/L Torso	18	25
R/L Torso (rear)		11
R/L Arm	14	28
R/L Leg	18	36

## Weapons and Ammo

	<b>Location</b>	<b>Critical</b>	<b>Tonnage</b>
ER Large Laser	RA	2	5
ER Large Laser	LA	2	5
SRM 6	RT	2	3
SRM 6	LT	2	3
Ammo (SRM) 30	RT	2	2
LB 10-X AC	LT	6	11
Ammo (LB-X) 20	RT	2	2
Ammo (LB-X) 10	LT	1	1
Small Laser	RA	1	.5
Small Laser	LA	1	.5
Jump Jet	RL	1	1
Jump Jet	LL	1	1
Jump Jet	CT	1	1

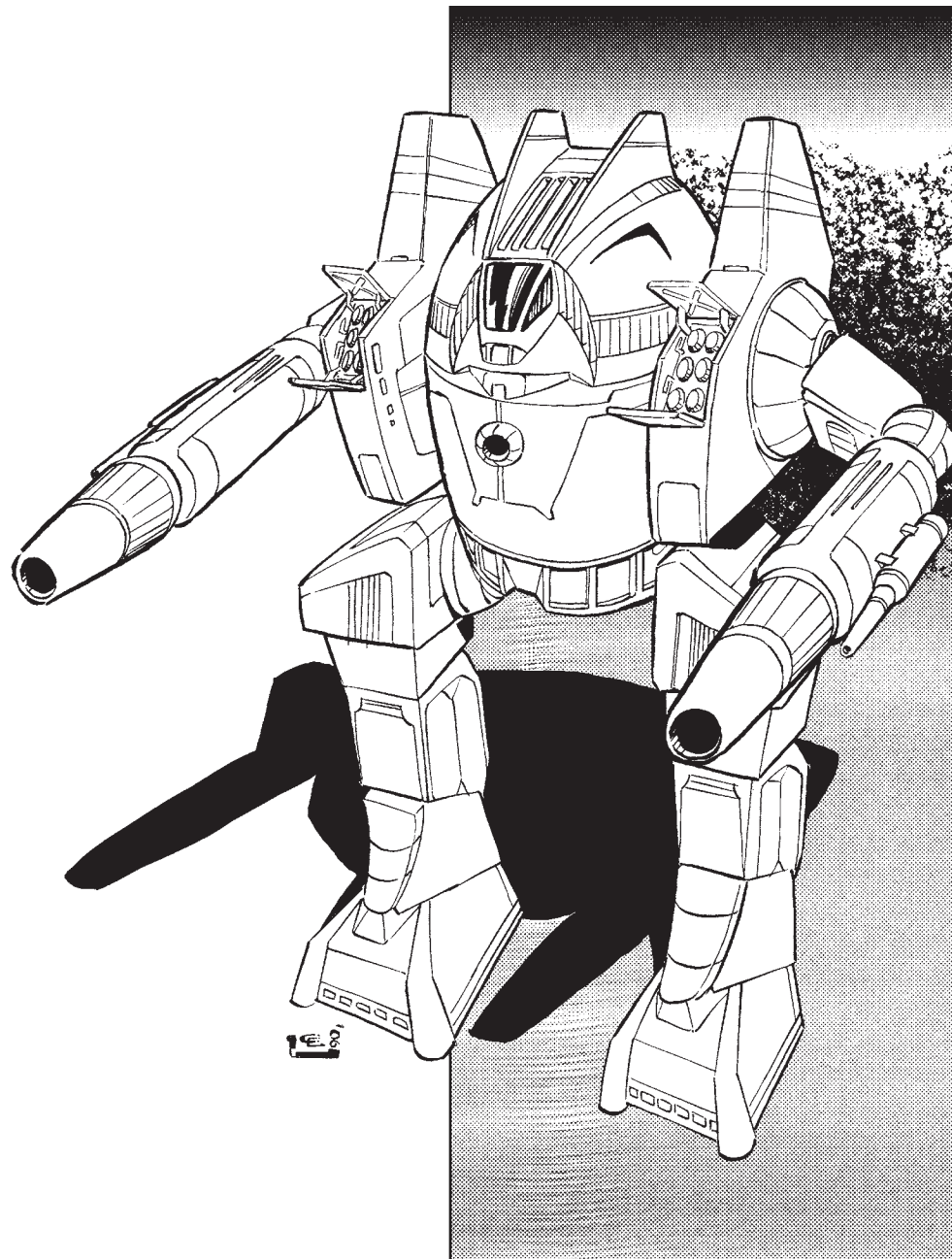

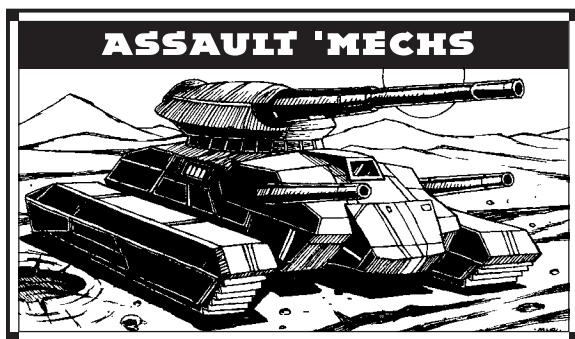

**Mass:** 90 tons

**Chassis:** Star League XT

**Power Plant:** GM 270

**Cruising Speed:** 32 kph

**Maximum Speed:** 54 kph

**Jump Jets:** HildCo Model 10

**Jump Capacity:** 90 meters

**Armor:** Grumman-3 Ferro Fibrous with CASE

**Armament:**

1 M-7 Gauss Rifle

1 Holly LRM-20 Missile Rack

1 Holly SRM-6 Missile Rack

2 Harmon Starclass Medium Lasers

**Manufacturer:** StarCorps Industries

**Primary Factory:** Son Hoa

**Communications System:** Hector VII

**Targeting and Tracking System:** Starlight LX-1

## Overview

Having served the SLDF with distinction for almost two centuries, the *Highlander* earned its place in the history books with an absolutely stellar combat record. Yet it is not its withering firepower or superior armor protection that gives this 'Mech its battlefield reputation. Instead, it is best known, and widely feared, because of the infamous "*Highlander* burial."

## Capabilities

The *Highlander* entered service with the SLDF in the late 26th century, and within decades it had made its way into nearly every Regular Army BattleMech regiment. The reason was very simple: it was an

incredibly capable 'Mech. Originally meant to be the focus of a city or stronghold's defense, the *Highlander*'s mobility and wide-ranging weapons proved that it could command just about any battlefield, no matter the circumstance.

With a Gauss rifle and Holly LRM-20 launcher as its primary weapons, the *Highlander* can engage targets at extreme ranges with withering fire. And if its opponents manage to close in past its LRM's minimum range, it can deliver the coup de grace with its SRM rack and medium lasers. Fifteen-and-a-half tons of ferro-fibrous armor and CASE-protected torsos make it an all-but-unstoppable force—the perfect assault 'Mech. And then there is perhaps its greatest asset—its integral HildCo jump jets. The "death from above" tactic had long been considered a desperate move, but with the advent of the *Highlander* and its specially reinforced legs, it became a virtual art form. MechWarriors used the threat of a "*Highlander* burial"—which could literally drive a light 'Mech into the ground—to scare away all but the boldest of enemies.

## Deployment

As it did within the SLDF of old, the *Highlander* serves in attack, fire, assault, and command lances throughout the Com Guards and Blakist Militia. Relatively few found their way into the DCMS in the 3030s, almost all of which had been completely stripped of advanced technologies, but a handful remain in service inside the Ghost regiments. Perhaps unsurprisingly, the Clans are even known to have put an original *Highlander* onto the field.

Since the re-opening of StarCorps' factories on Son Hoa in 3057, brand-new *Highlanders* have also been pouring into the ranks of Lyran BattleMech units, both regular army and mercenary. Assigned to pro-Katherine units prior to and during the FedCom Civil War, most remain within the Lyran armed forces, though some managed to find their way into the AFFS.

## Variants

When ComStar began to upgrade its 'Mech forces in the late 3050s, the *Highlander* was one of the many designs that saw a minor facelift. Now sporting double-

strength heat exchangers, a Streak SRM-4, an Artemis-enhanced LRM-20 and a C<sup>3</sup>i suite, the new HGN-736 is an even more potent enemy.

The Lyran Alliance went a completely different route with its new *Highlanders*, eventually introducing two distinctly Steiner variants. A class-20 LB-X autocannon, two Streak racks and an assortment of ER and pulse lasers make the first a devastating in-fighter. The second mounts a heavy Gauss rifle, backed by an Artemis-equipped LRM-15 launcher as well as a Streak launcher and three ER lasers, and it has already garnered a fearsome reputation among the Blakist MechWarriors it has faced.

## Notable MechWarriors

**Colonel Porthos Argyle Jameston Stansfield-Turner:** No one quite knows where he came from, or what military, if any, actually trained him, but the self-styled Colonel Porthos Stansfield-Turner, or "Colonel Stans" as he instructs everyone to call him, appeared two years ago on Procyon to fight the "evil overlords." Flamboyant, and quite likely insane, he nonetheless is a popular figure on the world. If his press can be believed, he has single-handedly taken down scores of Blakists; at the very least, there are tri-vid recordings of his destruction of five separate WoB 'Mechs—all lighter than his *Highlander*, and each of which fell prey to his own unique *Highlander* burial.

**"Eddie":** The *Highlander* known only as "Eddie" appeared on Le Blanc during the War of 3039, fighting alone against Theodore Kurita's raiding force. Ever since, it has moved from mercenary unit to mercenary unit, and from one end of the Inner Sphere to the other. The 'Mech is unmistakable—bright red with crisscrossing white and black stripes—but its pilot is unknown, always wearing a mask and plain jumpsuit outside of the cockpit. He has never wanted for work, choosing his contracts carefully. After a long run on Addicks, he is currently making his way into the Combine with a group of DCMS prisoners he freed from a FedSuns POW camp.

# HGN-732 HIGHLANDER

Type: **Highlander**

Technology Base: Inner Sphere

Tonnage: 90

Battle Value: 2,227

## Equipment

		Mass
Internal Structure:		9
Engine:	270	14.5
Walking MP:	3	
Running MP:	5	
Jumping MP:	3	
Heat Sinks:	12	2
Gyro:		3
Cockpit:		3
Armor Factor:	277	15.5

	Internal Structure	Armor Value
Head	3	9
Center Torso	29	40
Center Torso (rear)		16
R/L Torso	19	28
R/L Torso (rear)		10
R/L Arm	15	30
R/L Leg	19	38

## Weapons and Ammo

	Location	Critical	Tonnage
Gauss Rifle	RA	7	15
SRM 6	LA	2	3
2 Medium Lasers	RT	2	2
Ammo (Gauss) 16	RT	2	2
CASE	RT	1	.5
Jump Jet	RT	1	2
LRM 20	LT	5	10
Ammo (LRM) 12	LT	2	2
Ammo (SRM) 30	LT	2	2
CASE	LT	1	.5
Jump Jet	LT	1	2
Jump Jet	CT	1	2

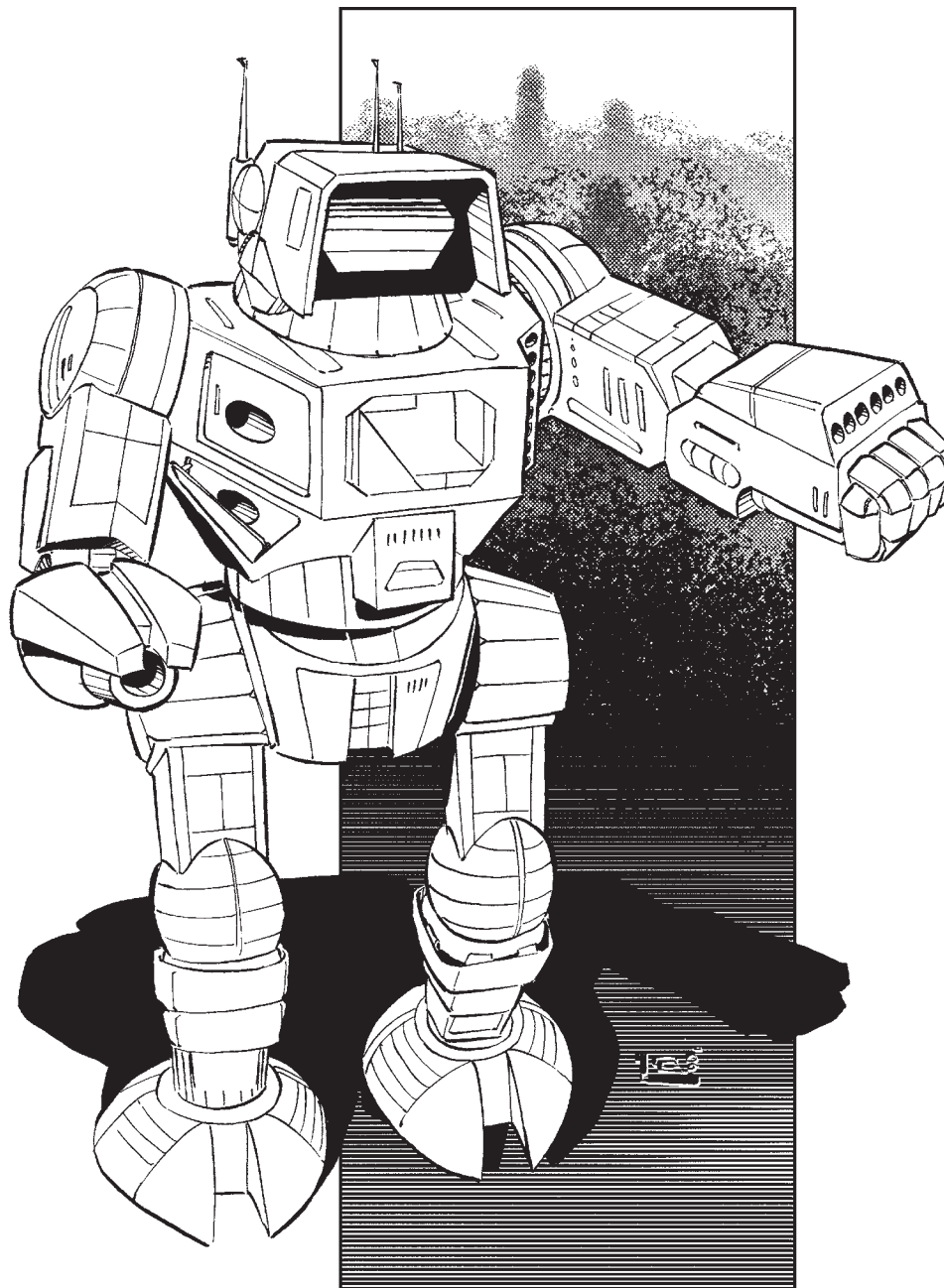

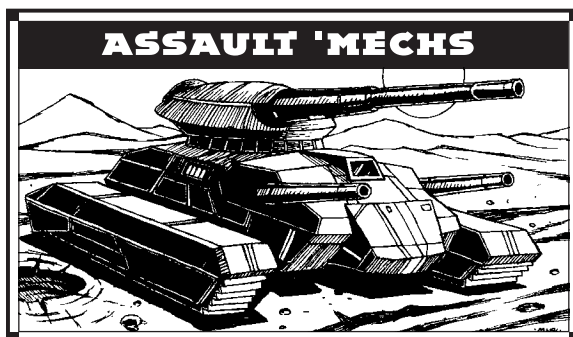

**Mass:** 100 tons

**Chassis:** Hollis Mark II

**Power Plant:** Vlar 300 XL

**Cruising Speed:** 32 kph

**Maximum Speed:** 54 kph

**Jump Jets:** None

**Jump Capacity:** 0 meters

**Armor:** Aldis X Ferro-Fibrous with CASE

**Armament:**

1 Simpson LRM-15

1 Tronel XIII Large Pulse Laser

2 M-7 Gauss Rifles

2 Hovertec Streak SRM-2s

**Manufacturer:** Cosara Weaponries,  
Starcorps Industries

**Primary Factory:** Northwind, Mars (Cosara);  
Son Hoa (Starcorps)

**Communications System:** Dalban Comcline

**Targeting and Tracking System:** Dalban HiRez-B

## Overview

A terror on the battlefield since its inception right before the collapse of the original Star League, the *King Crab* is widely noted for its ability to rapidly destroy most BattleMechs under eighty tons. Designed by scientists at Cosara Weaponries under orders from General Kerensky, the KGC-000 fulfilled its defined role admirably, though it proved to be nowhere near the command vehicle that Defiance Industries' later *Atlas* was.

Most *King Crabs* went with Kerensky on his Exodus, including all the remaining -010 platforms; those

that remained behind were quietly snapped up by ComStar and mothballed on Terra. After the arrival of the Clans and the Battle of Tukayyid, most Com Guard commanders found that the original Emperor-D autocannon design could not close fast enough with Clan machines to do any significant damage. Cosara Weaponries produced the -001 variant after being approached by ComStar; the increased range regained the *King Crab* some much-needed reach. Pleased with their success, ComStar gave Cosara the green light to mass-produce the upgraded *King Crab* for general market sale, with ComStar reaping a large percentage of the yearly profit.

Production on Northwind ceased after the Word of Blake blockaded the system, and scattered intelligence reports indicate that the Cosara plant was taken over by the Blakists. After some months of being shut down, the plant went back online in late 3069, steadily producing and shipping a newer *King Crab* variant to Protectorate forces.

Deprived of a major weapons supplier, First Precentor Dow took an unusual step for the once-secret organization. Hiring a small mercenary company that specialized in corporate espionage, ComStar was able to infiltrate the Cosara plant and steal the new engineering plans. ComStar then turned to Starcorps Industries and offered the burgeoning manufacturer the chance to produce a new *King Crab* variant, the KGC-007. Eager to bolster their product lineup, StarCorps accepted, and the first -007s are due off the Son Hoa line in late 3071. Both the LAAF and AFFC have already purchased the first three production runs.

## Deployment

Not as common as the *Atlas*, the *King Crab* is nonetheless still seen among many heavier assault groups. Variants are hard to determine from first glance, as the body design has remained unchanged for hundreds of years. Normally, what variant a pilot is facing can only be determined after it fires, which is a less-than-ideal situation.

## Variants

The KGC-010 is a recent discovery from Star League archives. Apparently conceived under a top-

secret weapons deal between Cosara-Mars and the Hegemony, the 010 was a deadly command 'Mech capable of taking down even an *Atlas*. Sporting Star League-developed PPCs and dual LB-10X cluster cannons, the KGC-010 was a fearsome sight for many House warriors, especially since the frame of the *King Crab* was identical to the more commonly produced KGC-000 design. Though the weapons loadout is typical to other assault 'Mechs, the Cosara-Mars PPC platform utilized a non-standard weapon housing that had many enemy pilots believing the KGC-010 sported a new and powerful weapon design. To Wolfnet's knowledge, no 010 platforms still exist.

As reported by ComStar, the Blakist variant mounts dual heavy PPCs, dual light autocannons, paired ER medium-range lasers and sophisticated electronics. Additionally, pilots facing down the new KGC-008 are warned that this new *King Crab* sports jump jets. Spotting the 008 is relatively easy, as Cosara has altered the design's look somewhat by softening its hard lines and giving it a more streamlined silhouette.

The Davion and Steiner variant mounts dual rotary cannons, paired light PPCs, one of the Suns' newly designed plasma rifles, and a Streak 6-pack. It also mounts the Lyran's new light ferro-fibrous armor, giving it more protection in a stand-up fight. Both variants have reverted to the Vlar 300 and a CASE system, giving the *King Crab* unparalleled survivability.

## Notable MechWarriors

**Precentor Christopher Schmidt:** Commander of the ROM forces on Luthien, Schmidt pilots one of the newer 008 variants to deadly effect. Intelligence from O5P indicates that Schmidt is the one most likely responsible for detonating three tactical nuclear bombs within the Luthien Armor Works megaplex, completely destroying the facility and killing an estimated 80,000 people. The First Genyosha has made it a priority to bring down Precentor Schmidt and his Level II *Circle of the Holy*, though the presence of some Manei Domini troops within the unit makes that a difficult mission.

# KGC-001 KING CRAB

Type: **King Crab**

Technology Base: Inner Sphere

Tonnage: 100

Battle Value: 2,221

## Equipment

		Mass
Internal Structure:		10
Engine:	300 XL	9.5
Walking MP:	3	
Running MP:	5	
Jumping MP:	0	
Heat Sinks:	13	3
Gyro:		3
Cockpit:		3
Armor Factor:	295	16.5

	Internal Structure	Armor Value
Head	3	9
Center Torso	31	43
Center Torso (rear)		15
R/L Torso	21	30
R/L Torso (rear)		10
R/L Arm	17	34
R/L Leg	21	40

## Weapons and Ammo

	Location	Critical	Tonnage
Gauss Rifle	LA	7	15
Ammo (Gauss) 16	LA	2	2
Gauss Rifle	RA	7	15
Ammo (Gauss) 16	RA	2	2
LRM 15	LT	3	7
Ammo (LRM) 8	LT	1	1
Streak SRM 2	LT	1	1.5
Ammo (SRM) 50	LT	1	1
CASE	LT	1	.5
Large Pulse Laser	RT	2	7
Streak SRM 2	RT	1	1.5
Ammo (Streak) 50	RT	1	1
CASE	RT	1	.5

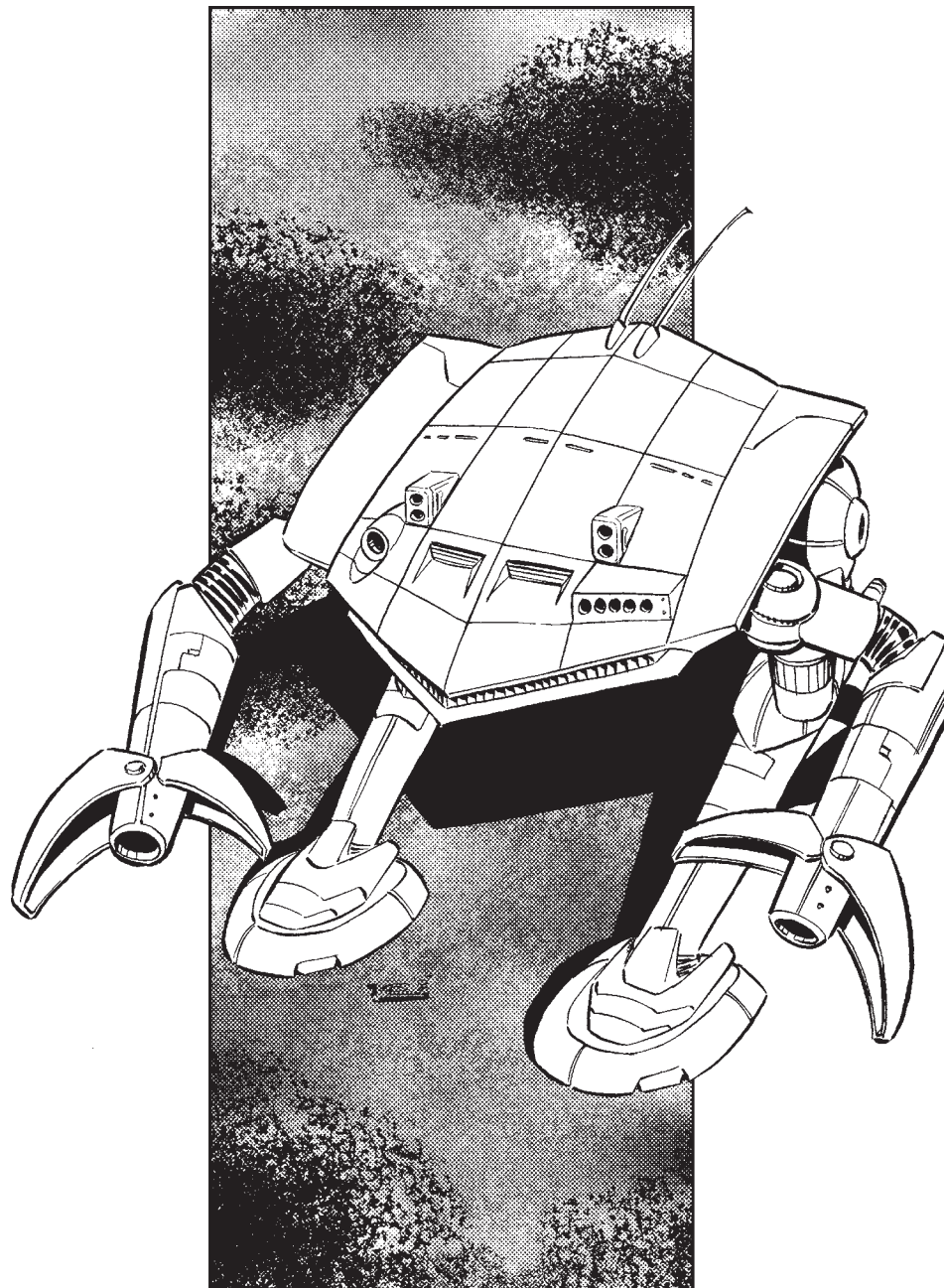



**Mass:** 20 tons

**Frame:** Newhall 3P5

**Power Plant:** Rawlings 200

**Armor:** StarGlo Ferro-aluminum

**Armament:**

3 Omicron-Plus Medium Lasers

1 Maxell Small Laser

**Manufacturer:** Newhart Industries

**Primary Factory:** Thorin (destroyed)

**Communications System:** 42 Transitar

**Targeting and Tracking System:** O/P 3000

## Overview

Designed and built as a first-response fighter for most militaries across the Inner Sphere, the *Trident* was extremely successful after its debut in 2717 until rendered obsolete by the *Cheetah*. Even so, Newhart continued to produce the *Trident* in limited numbers, often selling them at or near cost to down-and-out mercenary companies and backwater militias. The design was durable enough that Newhart sold the production license rights to several smaller companies during the First Succession War. The last *Trident* rolled off the assembly lines in 2825.

The market triumph of the *Cheetah* almost killed the *Trident*, though most of the *Trident*'s systems were easy to repair and remained in production throughout the Successions Wars. But the last nail in the *Trident*'s coffin was a component that disappeared early in the Succession Wars, the *Trident*'s ferro-fibrous armor. The destruction of the last Inner Sphere ferro-fibrous

foundry in 2810 did not prevent Newhart and its licensees from attempting to market a *Trident* with more conventional armor. The loss in protection was technically minor, but exaggerated in pilot circles until the *Trident* was no longer marketable.

Rumors have surfaced in recent years of a new program designed to utilize the *Trident*'s quick speed, resilient airframe, and energy-based load-out. Though extremely little is known at this time, one piece of information has been proven true—several partially built *Trident* hulls were seized from a Word of Blake ship in the Orestes system in 3069, of which none contained a recognizable cockpit assemblage. Whether these are being tested as advanced teleoperated missile systems or something more remains to be seen.

## Capabilities

The *Trident*'s light frame made it ideal for carrier duty as well as an extremely high-performance atmospheric aircraft. Because of its durability, the *Trident* was ideal for both ground support roles and a spaceborne interceptor. The advanced O/P 3000 tracking system could almost fly the fighter itself—in fact, many *Trident* pilots would joke that they were only needed to pull the trigger in a combat environment.

## Deployment

Thanks to its versatility in a defensive role, *Trident*s sold extremely well across the Inner Sphere even after being pushed from the market by Imstar Aerospace's *Cheetah*. Newhart's *Trident* design can still be found in many Periphery realms, backwater militias, and independent states. Such designs, however, are most likely equipped with less-advanced armor, requiring a high degree of pilot caution to make best use of the plane. It is probably because of this that the Outworlds Alliance and its talented pilots corps has the largest number of *Trident*s in their inventories, mostly used as training vessels for their cadets.

## Variants

No known variants of the *Trident* are known to exist, though considering Newhart's penchant for tin-

kering it is possible that some prototypes were built to experiment with other weapon load-outs. Considering the fighter has no built-in capacity for handling ammunition-based weapons, weapon mixes are limited due to the high heat output by energy-based systems.

If rumors of a high-performance teleoperated version are to be believed, it is quite possible that the additional room normally taken by the cockpit could allow another laser system or even higher-grade weapons.

## Notable Pilots

**Force Captain Maribel Ionas:** One would never suspect such a small, shy woman to be considered Zion's greatest air ace during the Third Succession War. Not one to advertise or brag (unlike her squadron-mates), Ionas racked up an impressive twenty-two space, eighteen air, and twelve ground kills during her four-year tour with the Zion militia. Capable of putting her custom *Trident* through every conceivable maneuver, Ionas even invented tactics for the Zion Air Militia during the brutal war years. Unfortunately, the force captain was shot down during an intercept mission raiding Confederation fighters, though she managed to take down a CCAF *Chippewa* even as her *Trident* disintegrated around her. In her honor, the Ionas Flight Museum (located in downtown Trupelo, her hometown) was constructed and contains many rare and exotic machines from the League's history.

**Bandito "Frito" Yemen:** Cursed with a bad name and even worse luck, Yemen grew up among the bandits of the Tortuga Dominion. Though possessing a knack for battle awareness, Yemen could not hit the broadside of a *Behemoth* DropShip if he was standing on it. Nonetheless, Yemen's superb flight skills have made him one of the best reconnaissance pilots in the Dominion. Yemen was tapped to head the newly created "Flying Muerto" squadron, a group of hand-selected pilots assigned to protect Paula "Lady Death" Trevaline's treasure ship, the *Sunset Sword*.



# TRN-3T TRIDENT

Type: **Trident**  
 Technology Base: Inner Sphere  
 Tonnage: 20  
 Battle Value: 521

Weapons and Ammo	Location	Tonnage	Heat	SRV	MRV	LRV	ERV
Medium Laser	Nose	1	3	5	—	—	—
Medium Laser	RW	1	3	5	—	—	—
Medium Laser	LW	1	3	5	—	—	—
Small Laser	Aft	.5	1	3	—	—	—

Equipment		Mass
Engine:	200	8.5
Safe Thrust:	12	
Max Thrust:	18	
Structural Integrity:	12	
Heat Sinks:	10	0
Fuel:	240	3
Cockpit:		3
Armor Factor:	35	2
	<i>Armor Value</i>	
Nose	10	
Wings	10/10	
Aft	5	

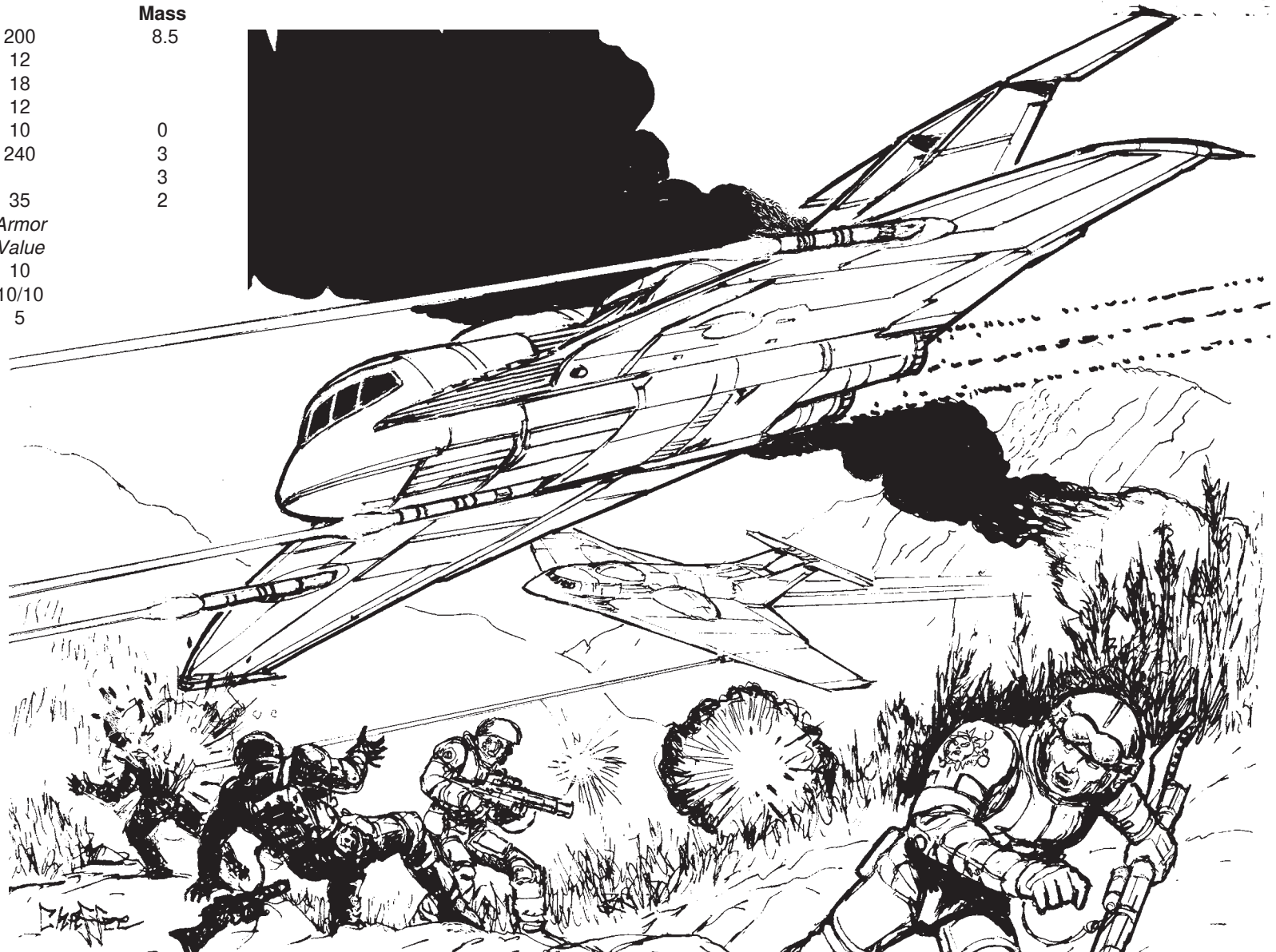



**Mass:** 25 tons

**Frame:** Mujika-L9 Aerospace

**Engine:** Shinobi 275-A

**Armor:** KX4 Ferro-Aluminum

**Armament:**

1 Maxell-UD6 Medium Laser

1 McCorkel Small Laser

**Manufacturer:** Caletra Fighters

**Primary Factory:** Terra

**Communications System:** Lockheed Matrix-V

**Targeting and Tracking System:** PhantomTrac 55

## Overview

Entering service six years behind schedule, the *Swift* seemed to be the victim of numerous technical and certification problems. There were indeed technical issues, but rather than the “gremlins” that were reported to the SLDF, Caletra Fighters of Fletcher were working to integrate technologies to a level unprecedented even for the Star League and to develop the necessary electronics and software. Caletra’s perseverance with the development problems resulted in an aircraft whose performance is rivaled only by the advanced technologies of the Clans.

## Capabilities

Built as a carrier aircraft with high performance but limited endurance, the *Swift* finally entered service in 2682 and immediately found itself the subject of intense scrutiny after an electronics-triggered landing accident; while on approach the *Swift* ejected its

pilot without warning, leaving the unmanned aircraft to crash and cause significant damage. No fault was ever found with the electronics or software, and the accident report listed the crash as “unforeseeable.” Only a subsequently near-flawless flight history and pilot experience eroded the suspicion the accident engendered.

The central computer system of the *Swift*, the B-TT7i, oversees all aspects of the aircraft, ranging from navigation and control interfaces to communications and fire control. Voice-based feedback systems enable the B-TT7i to provide information to the pilot in a timely manner, but they met with mixed pilot reaction. The female voice soon received the nickname “Bitching Betty” and Caletra had to quickly update the system with a cutoff once they learned pilots took drastic action to silence Betty’s nagging, including shutting down the B-TT7i after launch; later models allowed pilots to set thresholds for voice warnings, muting the system for all but the most significant warning messages.

For all the criticism its voice module drew, the revolutionary integration of the *Swift* became popular with pilots and technicians alike. Plug-and-play components allowed engineers to remedy problems quickly and efficiently while pilots were freed from many of their mundane piloting duties, leaving them free to fly the aircraft and deal with threats. With the design capable of generating 10Gs of thrust—a feat matched only by the *Bashkir* and exceeded, just, by the *Avar*—the freedom from such tasks is of considerable benefit to the pilot.

However, this performance comes at a price. The Shinobi engine takes up sixty-percent of the airframe, with much of the remainder occupied with fuel, avionics, and life support. Only three and a half tons remain for equipment—two tons of ferro-aluminum armor, a single UD6 medium laser and a McCorkel small laser. The *Swift* can thus only sting its targets and hope none of them are fast enough to swat it back.

## Deployment

Serving in a dual role as dogfighter and recon platform, the *Swift* gained grudging respect from pilots, and in its century of service grew to be the principal light fighter of the SLDF. A series of electronic and software

upgrades kept the design in service even when faced with competition from newer designs and almost a hundred accompanied the Kerensky Exodus. Relatively few were exported to the Great Houses, however, and as a consequence the design vanished during the Succession Wars. The Clans continued to use the design in their second-line forces, particularly as a trainer for Omnifighters, many of which can trace a lineage to the design’s integrated systems. ComStar also fields the design and was known to be manufacturing them at a plant in Asia.

## Variants

The complex electronics and small payload of the *Swift* gives little opportunity for modifications to the design. With the exception of the Clan upgrade—which uses ER lasers instead of the Star League models—no standard upgrades exist. ComStar fields some models that replace the weaponry with advanced sensor packages, but this recon variant has no official designation.

## Notable Pilots

**Captain Pan Ballard:** During Operation Liberation the SLDF carrier *Cairo* came under heavy attack by Rim Worlds fighters. Most of the warship’s fighter complement was elsewhere on a strike mission, and so defense fell to a light squadron headed by Pan Ballard and her *Swift*. The small aircraft had little chance of downing the enemy, but a combination of their skill and the aircraft’s agility allowed them to harass the Rim Worlds forces, drawing them away from *Cairo*’s weak spots and into its guns’ engagement envelope. The *Swifts* took a fearsome beating but delayed the attackers long enough for the air wing to return and drive off the Periphery troops. Captain Ballard was awarded the Medal of Valor, unfortunately posthumously.

# SWF-606 SWIFT

Type: **Swift**  
 Technology Base: Inner Sphere  
 Tonnage: 25  
 Battle Value: 301

Weapons and Ammo	Location	Tonnage	Heat	SRV	MRV	LRV	ERV
Medium Laser	Nose	1	3	5	—	—	—
Small Laser	Nose	.5	1	3	—	—	—

## Equipment

Engine: 275  
 Safe Thrust: 13  
 Max Thrust: 20  
 Structural Integrity: 13  
 Heat Sinks: 10  
 Fuel: 240  
 Cockpit: 3  
 Armor Factor: 35

Mass	Armor Value
15.5	
	0
	3
	3
	2
	10
	10/10
	5

Nose  
 Wings  
 Aft

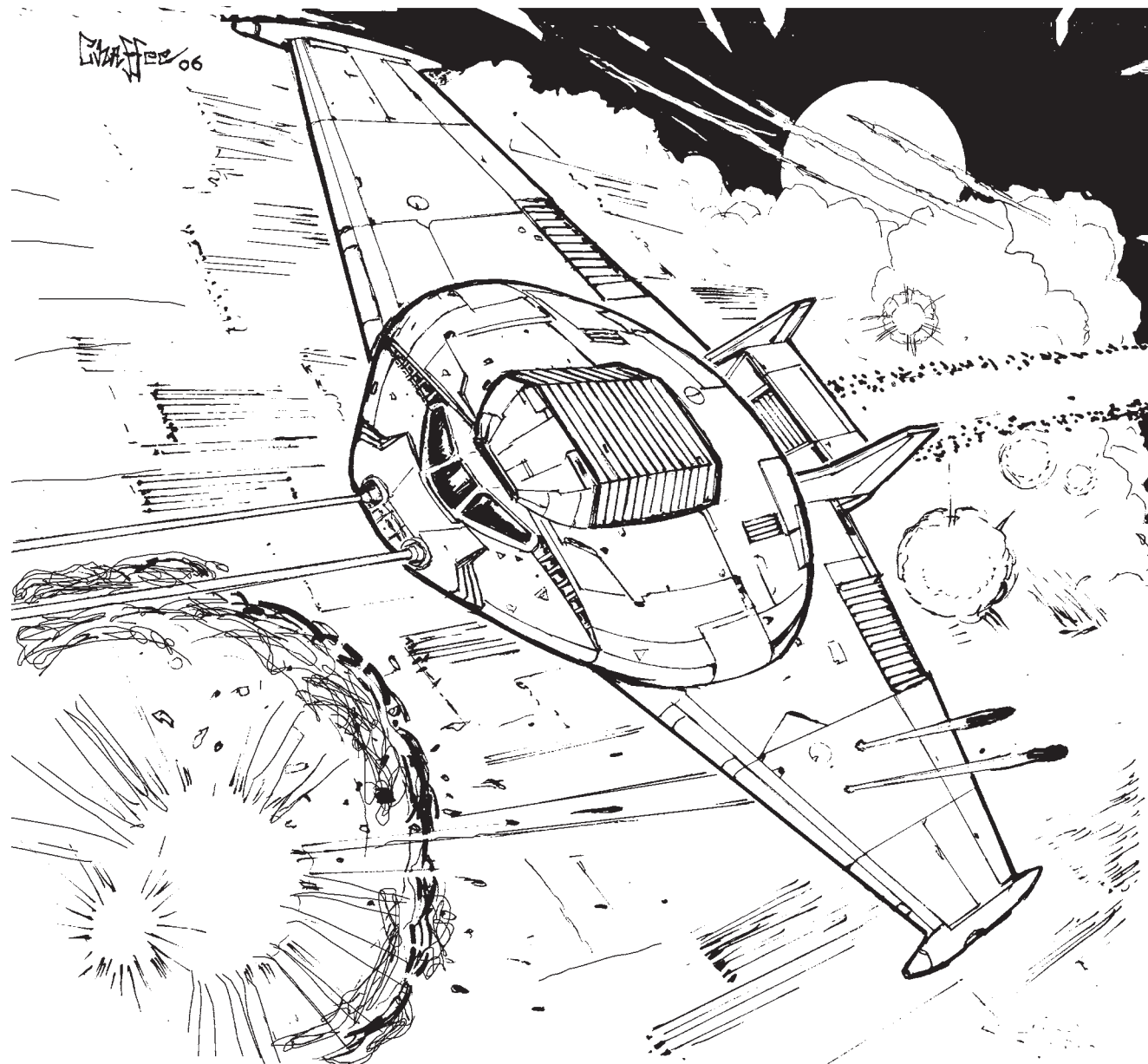



**Mass:** 30 tons

**Frame:** F-50/C

**Power Plant:** GM 150

**Armor:** Carbondale III

**Armament:**

- 1 Starcutter Particle Projection Cannon
- 1 Allied Technologies Model 2 Medium Laser
- 1 Allied Technologies Model 1 Small Laser

**Manufacturer:** New Age Systems Inc.

**Primary Factory:** Terra

**Communications System:** CMDSTAT 400-D

**Targeting and Tracking System:** Scope Paint

## Overview

In 2749, New Age Systems, noted for its popular *Gotha*-class fighter of the last century, put out a proof-of-concept aerospace fighter design designated the *Spad* to showcase their ideas of standardizing and simplifying repair, maintenance, and field changes. The SLDF Admiralty, impressed while watching the trials and reviews of the design, misread the proposal and ordered a full scale production of the 502 *Spad* to begin, instead of the expected request for a more advanced, combat-oriented version.

Despite this mix-up, the *Spad* was well received, and was regarded by many as one of the best light fighter designs in the Star League Defense force. Over two thousand were produced before the Amaris Coup, and their ease of maintenance meant many remained in service for centuries following Comstar's mothballing of the primary New Age Systems' Spad factory on Terra.

## Capabilities

The core feature of the *Spad* was not advanced weaponry or special construction material, but the expansion of the easy maintenance principles put forth by the *Crab* medium BattleMech a few decades earlier. Weapons and components were designed to be easily swapped out if damaged or modified, and the thick woven Carbondale armor plates not only were easily replaced, but also gave improved ablation against lasers hitting the hull.

What armament the *Spad* had was impressive for such a light chassis. While it contained the typical secondary weapons, a nose-mounted medium and small laser, the SPD-502 mounted a relatively massive PPC, able to punch through most light fighters' armor in a few volleys. The energy weapons were mounted inside the hull with retractable covers, providing both protection during re-entry and to disguise its full armament from its enemies.

## Deployment

While border regiments contained many of the original 502s, The Royal Regiments heavily utilized the more advanced 503 variants, often escorting *TigerSharks*, *Ahabs*, and other ground-support fighters. Those that survived left with Kerensky, leaving no more than a handful and a large cache of the original 502s for Jerome Blake to mothball. While many of the Successor States utilized the *Spad* in their militaries when they recruited SLDF units left behind, none contained a version more advanced than the 502.

During the opening stages of the Blakist Invasion of Liao, the defending aerospace regiment, Hell's Black Aces, lifted off confident of turning away the fleet. However, as the mercenaries engaged the advanced guard squadron of *Spads*, they found the PPCs doing much more damage than expected. This shock of heavy firepower turned back the interceptors, allowing the Blakists to establish an orbital perimeter over the capital city, though the first beachhead was eventually repulsed by the Dynasty Guards.

## Variants

Once the Clans appeared in the Inner Sphere, ComStar began a crash program updating their cache

of Star League era 502s to the more advanced 503 variant used by the SLDF Royal Regiments. This updated *Spad* carries double heat sinks, ferro-aluminum armor, and an extra-light engine to free up weight to upgrade the weapons. The PPC is swapped out for a more accurate large pulse laser, and the light weapons are exchanged for a pair of more lethal medium pulse lasers.

In the last few months another variant has appeared, designated as the 504. Possibly part of an all-new production line from a reopened New Age Systems' plant, this variant upgrades the design with an extra-light fusion engine, double heat sinks, and ferro-aluminum armor. A newly acquired heavy PPC replaces the original, and a pair of extended-range small lasers replaces the secondary weapons. This version has caught many off guard, including the elite Hell's Black Aces over Liao. Other than a few slightly different armor panels, there is no aesthetic difference between this and other production variants. Many Blakist 504-equipped squadrons are being used as quick-reaction anti-DropShip units, with the single heavy guns penetrating many transports' and escort crafts' hulls.

## Notable Pilots

**Blakes Black Barons:** A Level II of 504s assigned to the assault on Liao, these pilots were able to use their newly upgraded *Spads* to take the initial interceptors of Hell's Black Aces by surprise. The ability to do fifty percent more damage with their main gun crippled several Aces right away, forcing a general retreat and the establishment of an orbital perimeter for the DropShips over the drop zone. The Barons, unable to save the first beachhead alone, were able to support the second beachhead and break up several formations of Dynasty Guards attempting a counterattack.

# SPD-502 SPAD

Type: Spad  
 Technology Base: Inner Sphere  
 Tonnage: 30  
 Battle Value: 807

Weapons and Ammo	Location	Tonnage	Heat	SRV	MRV	LRV	ERV
PPC	Nose	7	10	10	10	—	—
Medium Laser	Nose	1	3	5	—	—	—
Small Laser	Nose	.5	1	3	—	—	—

## Equipment

Engine: 150  
 Safe Thrust: 7  
 Max Thrust: 11  
 Structural Integrity: 7  
 Heat Sinks: 10  
 Fuel: 400  
 Cockpit: 3  
 Armor Factor: 128

## Armor Value

Nose 46  
 Wings 25/25  
 Aft 32

Mass  
 5.5

0  
 5  
 3  
 8

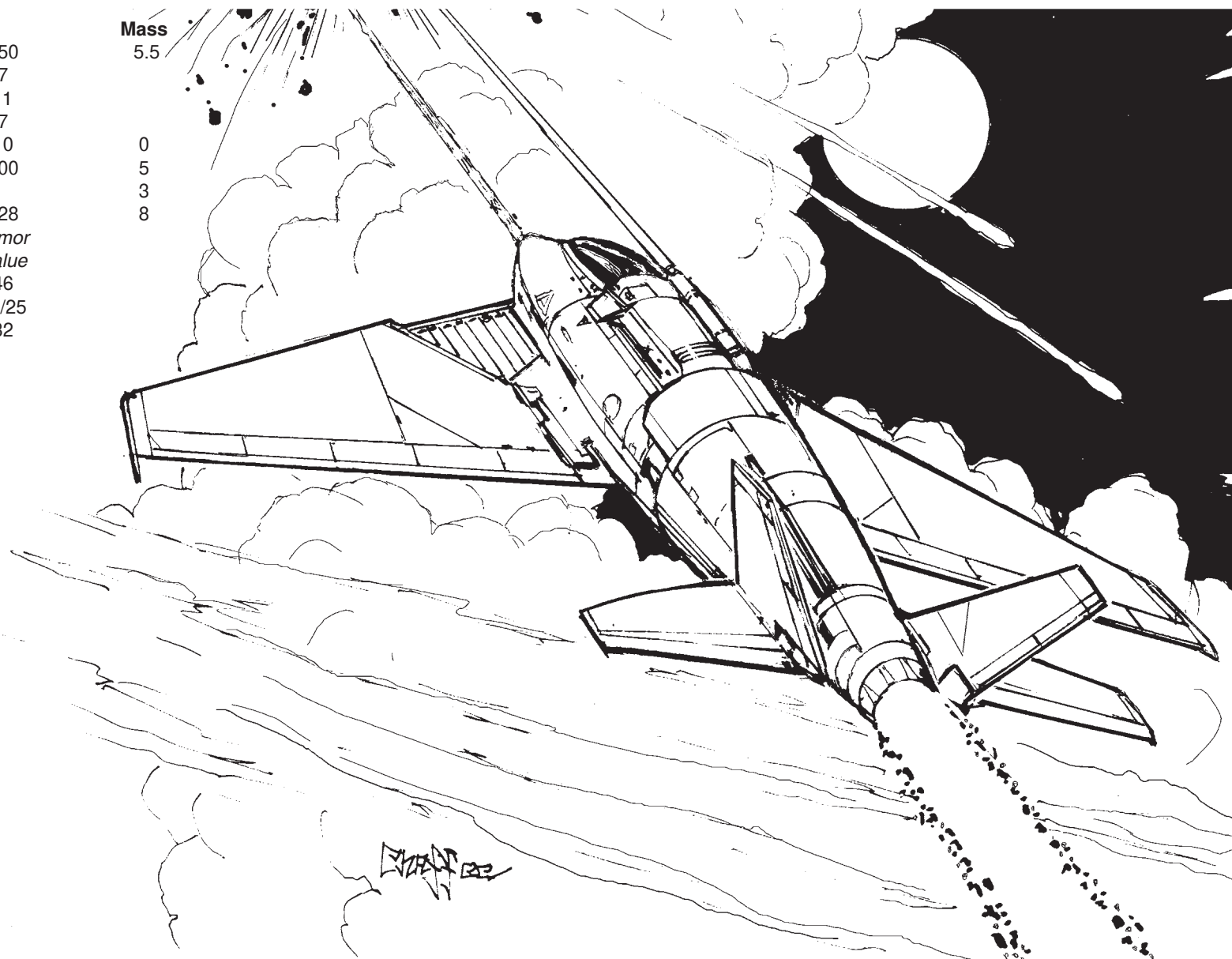



**Mass:** 35 tons

**Frame:** Saroyan Cavalier

**Power Plant:** Bangkok 140

**Armor:** SlabPanzer V

**Armament:**

1 Holly-10 LRM-10

1 BLW Blow Mark III Large Laser

1 BLW Blow Mark II Medium Laser

**Manufacturer:** Blow/Hookson Technologies

**Primary Factory:** New Earth (destroyed 2775)

**Communications System:** Orbitcom Model 11

**Targeting and Tracking System:** PS/1/12

## Overview

When the SLDF issued specifications for a light fighter, many aerospace companies declined to bid for the contract. Calling for a fast fighter with heavy firepower in all range bands and with heavier-than-average armor, it seemed the criteria were impossible for any design to meet.

One of the few companies to take up the challenge was Blow/Hookson Technologies of New Earth. In just under twenty months, their design team went from concept to flying prototype. Named the *Zero*, the new fighter made a strong impression when it appeared in 2703, going on to become one of the most respected light fighters the SLDF would ever deploy.

## Capabilities

To meet the SLDF's requirements, Blow/Hookson selected the reliable Holly LRM system and two of its

own Blow/Hookson laser systems. Of special note is the Blow Mark III, which can use five beam settings. These range from a wide beam that inflicts little damage but disrupts the target's electronics and tracking systems to a concentrated full power beam.

The Blow/Hookson engineers mounted the wings directly in front of the cockpit to provide protection from ground fire for the pilot during ground assaults. The engine cooling system is also in front of the cockpit, further protecting the pilot. The wings can fold toward the rear of the craft. In atmosphere this gives the *Zero* a phenomenal dive rate. Alternately, they can be extended, allowing the fighter to bounce off the atmosphere during reentry. Both are favorite tactics of *Zero* pilots in a dogfight.

The only significant flaw in this otherwise excellent design is the fuel system. Dispersed throughout the craft, battle damage can cut a fuel line and deprive the *Zero* of a portion of its fuel supply.

## Deployment

The first *Zeros* were assigned to the Nineteenth Striker Regiment in late 2703. Part of General Gaffa Pardoe's Third RCT, the new *Zero* received its baptism of fire over New Roland. Responding to attacks on the cities of Kujan Minor and Hickston, the Third encountered unmarked WarShips at the nadir jump point. Although outnumbered, General Pardoe chose to engage. While his capital ships took the unknown enemy fleet head on, the Third's aerospace fighters performed a wide flanking maneuver. Supported by *Chippewa* heavy fighters, the *Zeros* tore through the enemy rear, gutting an aging *Dart*-class cruiser. With the destruction of what proved to be the enemy flagship, the raiders fled. General Pardoe then redeployed his *Zeros* to support the neutralization of the now-stranded ground forces. Over two days of fighting, the *Zero* performed round the clock CAP and ground attack missions. Following the enemy surrender, interrogation revealed that WarShips hailed from the Rim Worlds Republic. The Rim Worlds government immediately disavowed any connection with the "renegades."

Thought lost during the Succession Wars, the *Zero* returned to service with the Com Guards. Serving with almost every Division, the design still proved to be effective during the fighting on Tukayyid. More recently both ComStar and the Word of Blake have deployed the fighter in their battles in the Chaos March region. It was only through the actions of its *Zero* fighter screen that any members of the Com Guard Eighty-third Division managed to escape from Tall Trees after the Blakist's Third and Fourth Divisions attacked.

The Clans also employ the *Zero* but usually reserve its use for solahma units or particularly disreputable second-line formations.

## Variants

Not wishing to run the risk of ruining a successful design, the Star League never modified the *Zero*. ComStar, on the other hand, has had to upgrade its aerospace forces to deal with advanced Clan Omni-Fighters. Designated the ZRO-115, this upgrade replaces the LRM launcher and large laser with a Kin-slaughter ER PPC and two Streak SRM-2 launchers. The additional heat the PPC generates necessitates that the heat sinks be replaced with double-efficiency models. This upgrade has also found its way into Blakist hands—carried there amidst the wave of defections that accompanied the revelation that Primus Mori was actually a deep-cover agent for House Kurita.

## Notable Pilots

**Demi-Precentor Bletchley Finch:** Formally of the Com Guards Eighty-third Division, Finch is one of the few to survive the bloodbath on Tall Trees. As an Adept in the White Cyclones, she found herself in command of the Division's surviving fighter screen. Rallying her fighters, Finch punched a hole through the Blakists' orbital forces and allowed her Division's DropShips to escape. In recognition of her skill and courage, Finch has been promoted and reassigned to command the *Invisible Truth's* fighter screen.

# ZRO-114 ZERO

Type: **Zero**  
 Technology Base: Inner Sphere  
 Tonnage: 35  
 Battle Value: 899

### Equipment

		Mass
Engine:	140	5
Safe Thrust:	6	
Max Thrust:	9	
Structural Integrity:	6	
Heat Sinks:	10	0
Fuel:	400	5
Cockpit:		3
Armor Factor:	160	10
	<i>Armor Value</i>	
Nose	61	
Wings	28	
Aft	43	

Weapons and Ammo	Location	Tonnage	Heat	SRV	MRV	LRV	ERV
LRM 10	Nose	5	4	6	6	6	—
Ammo (LRM) 12	—	1					
Large Laser	Nose	5	8	8	8	—	—
Medium Laser	Nose	1	3	5	—	—	—

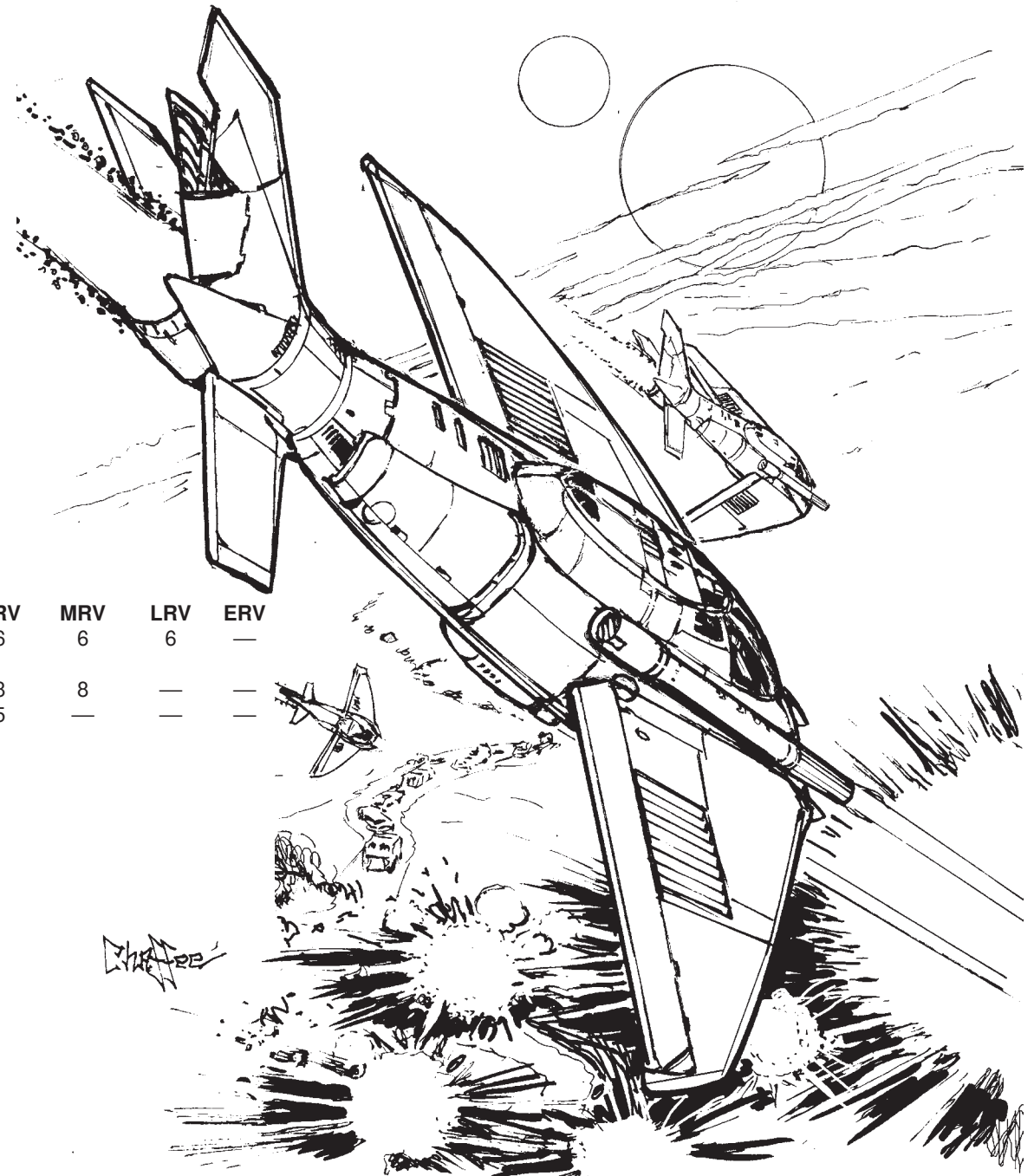



**Mass:** 40 tons

**Frame:** Shipil 10R

**Power Plant:** GM 200

**Armor:** StarGlo Ferro-Aluminum

**Armament:**

2 Starflash-1A Medium Lasers

2 Holly-8 LRM 15 Delivery Systems

**Manufacturer:** Iona Light Shipyards

**Primary Factory:** Capella (destroyed 2797)

**Communications System:** Rander 300

**Targeting and Tracking System:** SynCom Master

## Overview

The *Rogue* medium aerospace fighter never lived up to its name. The fighter carried a reputation for sluggishness at the controls, and though its supporters called this sluggishness nothing more than determination, even they would not call it nimble. When coupled with its light ammunition load and lack of serious supporting weaponry, very few are mourning the slow disappearance of this long-serving airframe.

## Capabilities

At forty tons, the *Rogue* is a medium-weight aerospace fighter designed for extra-atmospheric operations. A pair of Holly-8 LRM systems provide a respectable bombardment capability, making the *Rogue* a dangerous adversary. The designers provided the fighter with respectable armor that brought pilot after pilot home after particularly brutal engagements time and again. Although its performance is only average for a fighter of its mass, the *Rogue* is a speedy craft with enough fuel to expend its ammunition and

return to base. The two Starflash medium lasers are reliable weapons but lack the power to threaten another fighter.

## Deployment

During the original Star League, *Rogues* commonly deployed as a support or bombardment fighter. The range of its missile batteries provided aerospace commanders with an ace in the hole, giving them the ability to strike at engaged enemies from far away.

Since the destruction of the Iona shipyards in 2797, however, each lost *Rogue* is irreplaceable. The number of active *Rogues* has steadily dwindled until only a handful is left, sitting in the arsenals of the Com Guards and the Word of Blake. Studies suggest the Clans may possess some in older Brian Caches, but they have not chosen to deploy them in the Inner Sphere.

## Variants

Two variants became common during the *Rogue*'s initial deployment: the F model, which carried SRMs in place of the LRMs, and the L model, which replaced the missiles and their ammunition with a pair of large lasers and additional heat sinks. The destruction of the Iona shipyards sealed the fate of the *Rogue*.

Since that time, two notable variants have been recorded. The first, deployed during the Second Succession War by the Lyran Commonwealth, replaced the missiles and their ammunition with a pair of PPCs and two more heat sinks. This fighter performed poorly, often losing control after firing both PPCs.

The other *Rogue* variant flies with the Com Guard. Roughly ten percent of the existing *Rogues* are upgraded to the venerable L-model airframe. Com Guard engineers have replaced the heat sinks with double-strength versions, which saves enough mass to upgrade both the large medium lasers to pulse models. This version is popular as a dogfighter; many of the Com Guard's aces made their names piloting these fighters.

## Notable Pilots

**Leutnant Briana Wolfgram:** During the Second Succession War, *Leutnant* Wolfgram and her PPC-armed

*Rogue* gained great but short-lived fame on the Free Worlds League border. During an engagement with elements of the Marik Militia, Wolfgram's flight was ordered to delay a squadron of attacking *Lightning* medium fighters. Despite the odds, *Leutnant* Wolfgram and her wingman attacked.

Their first run through the squadron's formation broke them apart. Wolfgram began to fire her PPCs off-cycle, one weapon at a time while the other cooled. Between herself and her wingman, they managed to knock out a pair of the *Lightnings* before the attacking fighters regrouped. Very quickly the leutnant was forced to fire her PPCs in tandem, overheating her aging fighter. Equipment began to malfunction as she engaged the enemy squadron commander. During a head-to-head pass both pilots unleashed the full complement of their weapons. Wolfgram's PPCs struck the Marik pilot's cockpit, killing him. Unfortunately for her, the waste heat generated by the barrage knocked out her controls, and the two craft collided, destroying both.

**Adept Valerie Heron:** A pilot in the Com Guard Second Division, Valerie Heron gained great fame during the Blakist invasion of Epsilon Indi at the start of the Jihad. Piloting her upgraded *Rogue-LX* in the defense of the orbital insertion lanes, Adept Heron engaged repeated waves of Blakist fighters. She made ace in her first engagement, using her *Rogue*'s pulse lasers to ravage a Level II of *Cheetah* fighters. The surviving Blakist, an acolyte, reported that the Second Division had brought a ghost back with them from Huntress.

When the next wave of Blakist fighters arrived—two Level IIs of upgraded *Stingrays*—Adept Heron claimed three more kills before succumbing to massed PPC fire. One of Precentor Regis Grandi's final acts was to request ComStar's highest honors for Valerie Heron.



# RGU-133E ROGUE

Type: **Rogue**  
 Technology Base: Inner Sphere  
 Tonnage: 40  
 Battle Value: 971

**Equipment**

Engine: 200  
 Safe Thrust: 7  
 Max Thrust: 11  
 Structural Integrity: 7  
 Heat Sinks: 10  
 Fuel: 400  
 Cockpit: 3  
 Armor Factor: 98

*Armor Value*

Nose 30  
 Wings 27/27  
 Aft 15

Weapons and Ammo	Location	Tonnage	Heat	SRV	MRV	LRV	ERV
Medium Laser	Nose	1	3	5	—	—	—
LRM 15	Right Wing	7	5	9	9	9	—
Ammo (LRM) 8	—	1	—	—	—	—	—
LRM 15	Left Wing	7	5	9	9	9	—
Ammo (LRM) 8	—	1	—	—	—	—	—
Medium Laser	Aft	1	3	5	—	—	—

**Mass**  
8.5

0  
5  
3  
5.5

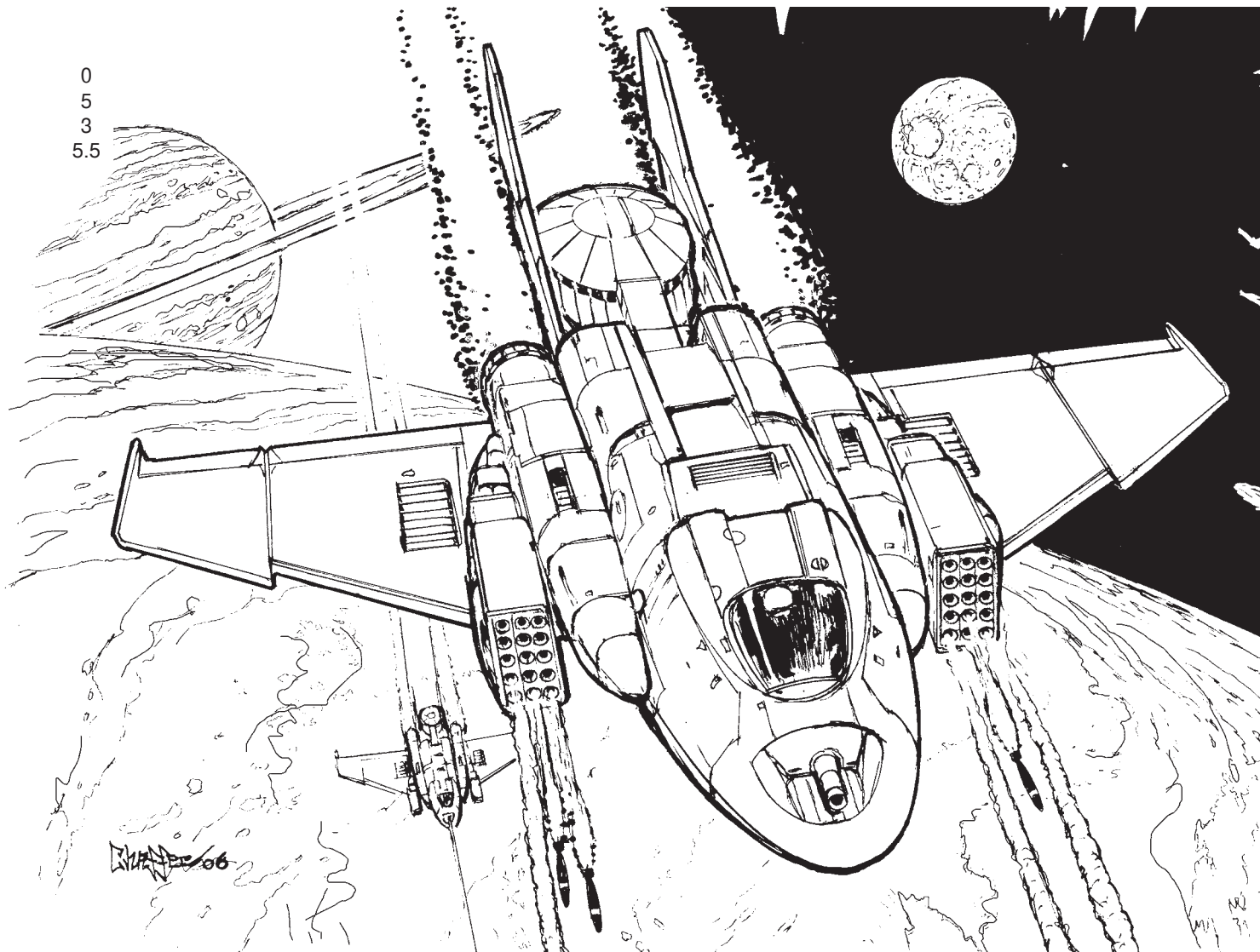



**Mass:** 45 tons  
**Frame:** Shipil 35-B  
**Engine:** PlasmaStar 270  
**Armor:** Fiber 10 Ferro-Aluminum  
**Armament:**  
1 Exostar IV Small Laser  
2 Maxell SR Large Lasers  
**Manufacturer:** Wangker Aerospace  
**Primary Factory:** Mars  
**Communications System:** Telestar Fortran  
**Targeting and Tracking System:** IMB 5000

## Overview

Designed as an agile medium-sized fighter, the *Tomahawk* excels at dogfighting, both in space and atmosphere. Developing 6Gs of thrust, its PlasmaStar engine allows the *Tomahawk* to attain significant velocity rapidly and maneuver nimbly. A mixture of ergonomic cockpit design and an advanced flight suit allows the pilot to remain alert and in control of such high-intensity maneuvers.

## Capabilities

With weapon systems that do not require ammunition and five tons of fuel, the *Tomahawk* is well geared to extended operations, and so the Star League commonly employed them as escorts or patrol craft. However, the laser weapons place a significant strain on the heat-dissipation systems, and numerous early modifications to the design were intended to mitigate this problem on the original THK-43 configuration. The

inclusion of high-efficiency heat sinks in models produced after 2680 cured the problem and created the THK-63 configuration, though a number of the earlier examples (of which thousands were built) were scrapped rather than updated because of significant chassis modifications to the design.

## Deployment

The *Tomahawk* established itself as a key part of the SLDF's aerospace forces, and despite issues with the design it remained in service for over a hundred years. A significant number survived the war against Amaris and were scattered throughout the Inner Sphere or else left with Kerensky. Most were lost in combat or scrapped for parts, but a few examples remained in museums and private collections.

While the Clans retain the design in their second-line forces, the largest number appear with ComStar and the Word of Blake, with a few examples slipping into the DCMS and FWLM due to technology exchanges. The Wangker plant on Mars, for many years mothballed, resumed production of the design in 3052 on the orders of the Precentor Martial and though its current disposition is unknown, it is believed to remain active in support of the Word of Blake Militia despite damage inflicted by both Wolf's Dragoons and ComStar's Case White.

## Variants

There have been five revisions of the *Tomahawk* over the years, of which only three saw widespread service. The prototype THK-33 featured only ten single heat sinks and had conventional armor, and it was quickly superceded by the THK-43 that reduced the armor slightly in favor of two additional heat sinks while using ferro-aluminum composites to compensate for the armor lost to the heat sinks. Heat dissipation issues with the first production model led to the development of the THK-53 that featured two additional heat sinks and replaced the weaponry with a trio of medium lasers and extra armor. This revision proved insufficient, and the fourth and best-known mode, the THK-63, came into being in 2680.

Recent years have seen a number of ComStar's venerable *Tomahawks*—a mix of -53 and -63 models—upgraded to the -63CS configuration. This follows the basic load-out of the common model but replaces the conventional large lasers with extended-range variants and drops the small laser in favor of an ER small. While improving the performance of the *Tomahawk* when facing opponents like the Clans, they have brought the design full circle, leading to a number of pilots complaining about heat-management issues.

Externally, the Clan second-line variant of the *Tomahawk* is indistinguishable from its Star League progenitor, though in many regards it resembles the ComStar version. Upgrading the lasers to Clan ER versions and using the space freed up by the compact Clan weapons to add additional armor and heat sinks results in a less problematic design than the 63CS. A sub-variant employs heavy lasers in lieu of the extended-range models, and while a number of pilots favor its hitting power, heat management is an issue and requires careful supervision.

## Notable Pilots

**Star Commander Gans:** While Clan Snow Raven has had considerable success in developing and producing new fighters, it also maintains a substantial number of vintage aircraft in its Touman. The *Tomahawk* is well represented and has seen considerable action in recent years. The freeborn Gans is one of its best-known pilots, having employed the design in bandit hunting operations in the Periphery and also against the Draconis Combine. The venerable design and its—by Clan standards—aged pilot have notched up an impressive kill total, utilizing the *Tomahawk's* speed, agility, and firepower to deadly effect. He is among only a handful of Raven freeborns allowed to attend the Khan's war council and one of only two allowed to display WarShip kill markers.

# THK-63 TOMAHAWK

Type: **Tomahawk**  
 Technology Base: Inner Sphere  
 Tonnage: 45  
 Battle Value: 1,038

Weapons and Ammo	Location	Tonnage	Heat	SRV	MRV	LRV	ERV
Small Laser	Nose	.5	1	3	—	—	—
Large Laser	LW	5	8	8	8	—	—
Large Laser	RW	5	8	8	8	—	—

Equipment		Mass
Engine:	270	14.5
Safe Thrust:	8	
Max Thrust:	12	
Structural Integrity:	8	
Heat Sinks:	12 [24]	2
Fuel:	400	5
Cockpit:		3
Armor Factor:	179	10
	<i>Armor Value</i>	
Nose	57	
Wings	42/42	
Aft	38	

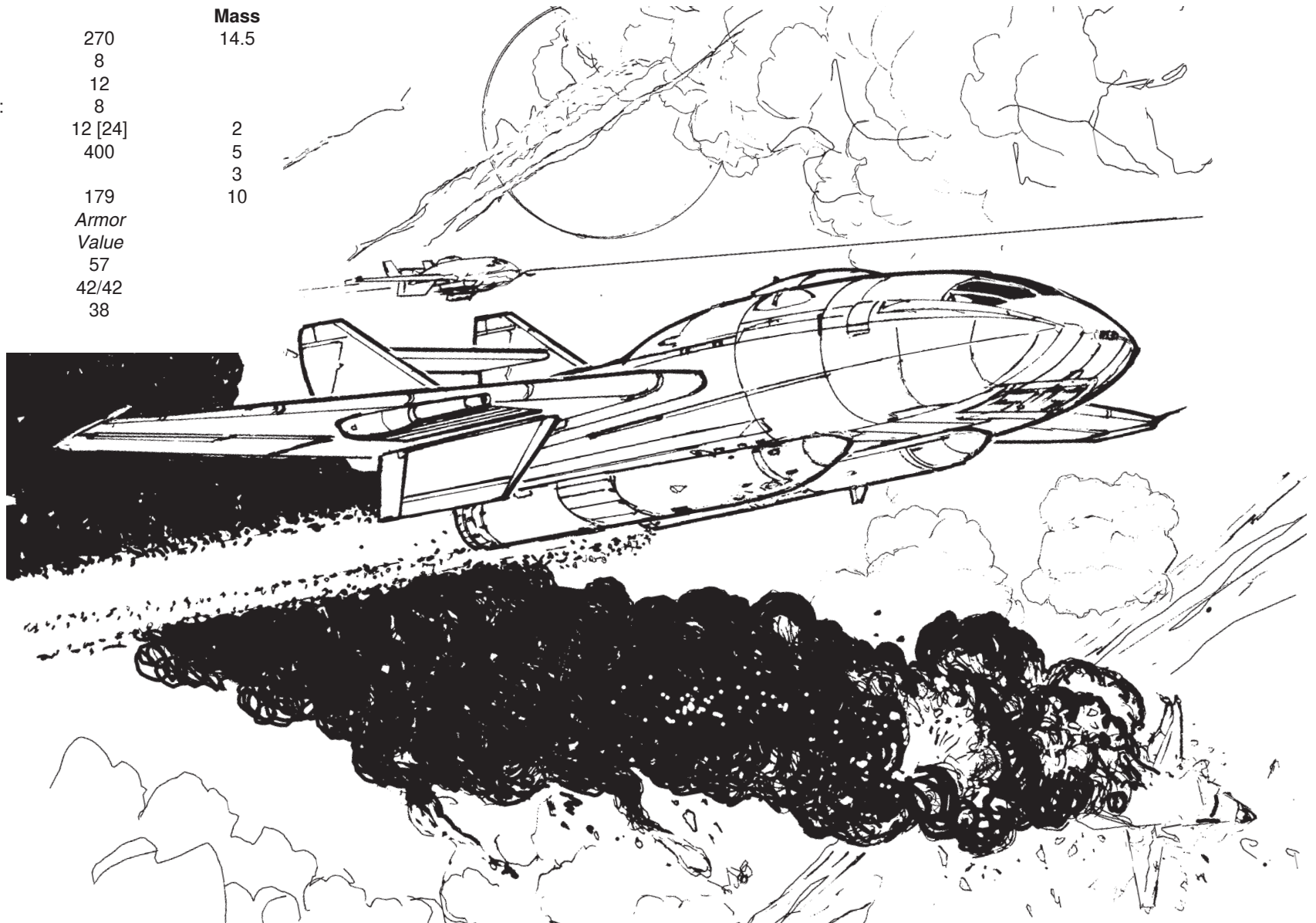



**Mass:** 50 tons

**Frame:** Wakazashi IX

**Power Plant:** Rawlings 250

**Armor:** SRT Ferro-Aluminum

**Armament:**

2 Diverse Optics/A Large Lasers

1 Starflash Medium Laser

**Manufacturer:** Mitchell Vehicles

**Primary Factory:** Graham IV (Destroyed 2775)

**Communications System:** Telecron L50

**Targeting and Tracking System:** Telecron M75 with Beagle Active Probe

## Overview

In 2671 Mitchell Vehicles released its first aerospace fighter, the *Hellcat*. A solid if uninspired design, it became a staple of second-line and militia forces, who particularly favored its low maintenance requirements and proven technology.

In an effort to raise the profile of the *Hellcat* design, Mitchell investigated a series of different variants for the fighter. The project eventually grew far beyond its initial intentions and became the basis for an entirely new design, dubbed the *Hellcat II*, which was commissioned for the SLDF in 2710. Ironically, the older and less advanced *Hellcat* design survived the Succession Wars, but the *Hellcat II* did not.

## Capabilities

Though based on the sixty-ton *Hellcat*, the *Hellcat II* has very little in common with its progenitor. Though

they share some sub-assemblies and weapons, the two fighters have completely different profiles. The *Hellcat* is a fairly standard design—albeit with over-wing air inlets—but the *Hellcat II* follows a flying-wing pattern, designed to minimize its emissions footprint.

Conceived as a heavy aerospace scout, Mitchell's engineers reduced the fighter's mass by ten tons allowing it to mount an engine of similar size to the *Hellcat* while being capable of twenty-two percent higher peak acceleration. The prototypes featured fifteen tons of armor as it was designed with survivability in mind, leading test pilots to nickname the fighter the "flying tank." In an effort to improve the craft's handling three tons of armor were removed, though the designers switched to ferro-aluminum armor to provide greater strength while not adversely affecting the craft's controls.

Two wing-mounted Diverse Optics large lasers provide the *Hellcat II*'s primary punch and a rear-mounted Starflash medium laser helps cover the fighter's tail. The *Hellcat II*'s most innovative feature is the inclusion of a Beagle Active Probe. Though more often seen on ground-based units, the probe provides greater accuracy for the craft's weaponry and provides a boost to the already excellent avionics, rivaling the detection abilities of some DropShips.

## Deployment

One of the newest fighters in the SLDF's arsenal, the *Hellcat II* had only seen a full deployment across the Inner Sphere by the 2750s. During the Amaris Coup, Republican forces were particularly brutal in their efforts to seize the Graham IV, resorting to widespread nuclear attacks to obliterate any of the factories and cities they could not capture. Though the *Hellcat II*'s factories survived the planet's capture, they were later destroyed during Kerensky's campaign to liberate Terra.

The majority of the remaining *Hellcat II*s left with Kerensky's forces, where they occasionally appear in Clan second-line forces or remained mothballed in ComStar's massive caches until the unveiling of the Com Guards in the 3030s. A number of the fighters remained in the hands of the Great Houses, though these

soon became a shadow of their former selves due to the degradation of technology.

## Variants

Mitchell created only one variant of the *Hellcat II*, the HCT-214. Employing fourteen double heat sinks to keep the fighter cool, the large lasers were upgraded to ER versions, and a nose-mounted medium laser was installed to provide additional short-range punch.

The few craft that remained in service with the Houses soon lost their advanced technologies, with the Beagle probe typically replaced with an extra heat sink and an additional half-ton of now-standard armor. This variant, known as the HCT-212, saw limited service throughout the Succession Wars.

With the coming of the Clans, ComStar upgraded its 213Bs to the 214 specifications, some of which subsequently fell into the Word of Blake's hands. With the Jihad raging, a number of ComStar *Hellcat II*s have been spotted in the 215 configuration. Though a time consuming and expensive refit, the engine is replaced with an extra-light version, freeing up mass to revamp the weapons array. Now sporting five light PPCs—two in each wing and one in the nose—and matched by forward and aft-mounted ER medium lasers, this variant turns the *Hellcat II* into a deadly fighter. Fifteen double heat sinks help cool the design, while the armor is upgraded to heavy ferro-aluminum composites, further increasing its survivability.

## Notable Pilots

**Adept VI Richard Loesch:** Engaged in raiding against Word of Blake targets in the Free Worlds League, Adept Loesch was the first pilot to get a confirmed kill in a new model 215 *Hellcat II*. Ambushing a WoB patrol in the Marcus system, Loesch's Level II of 215s destroyed a mixed Level II of upgraded *Hammerheads* and *Stingrays* while losing none of their own craft.

# HCT-213B HELLCAT II

Type: **Hellcat II**  
 Technology Base: Inner Sphere  
 Tonnage: 50  
 Battle Value: 1,147

Weapons and Ammo	Location	Tonnage	Heat	SRV	MRV	LRV	ERV
Large Laser	RW	5	8	8	8	—	—
Large Laser	LW	5	8	8	8	—	—
Beagle Active Probe	Nose	1.5	—	—	—	—	—
Medium Laser	Aft	1	3	5	—	—	—

Equipment	Mass
Engine:	250
Safe Thrust:	7
Max Thrust:	11
Structural Integrity:	7
Heat Sinks:	15
Fuel:	400
Cockpit:	3
Armor Factor:	215
	<i>Armor Value</i>
Nose	68
Wings	51/51
Aft	45

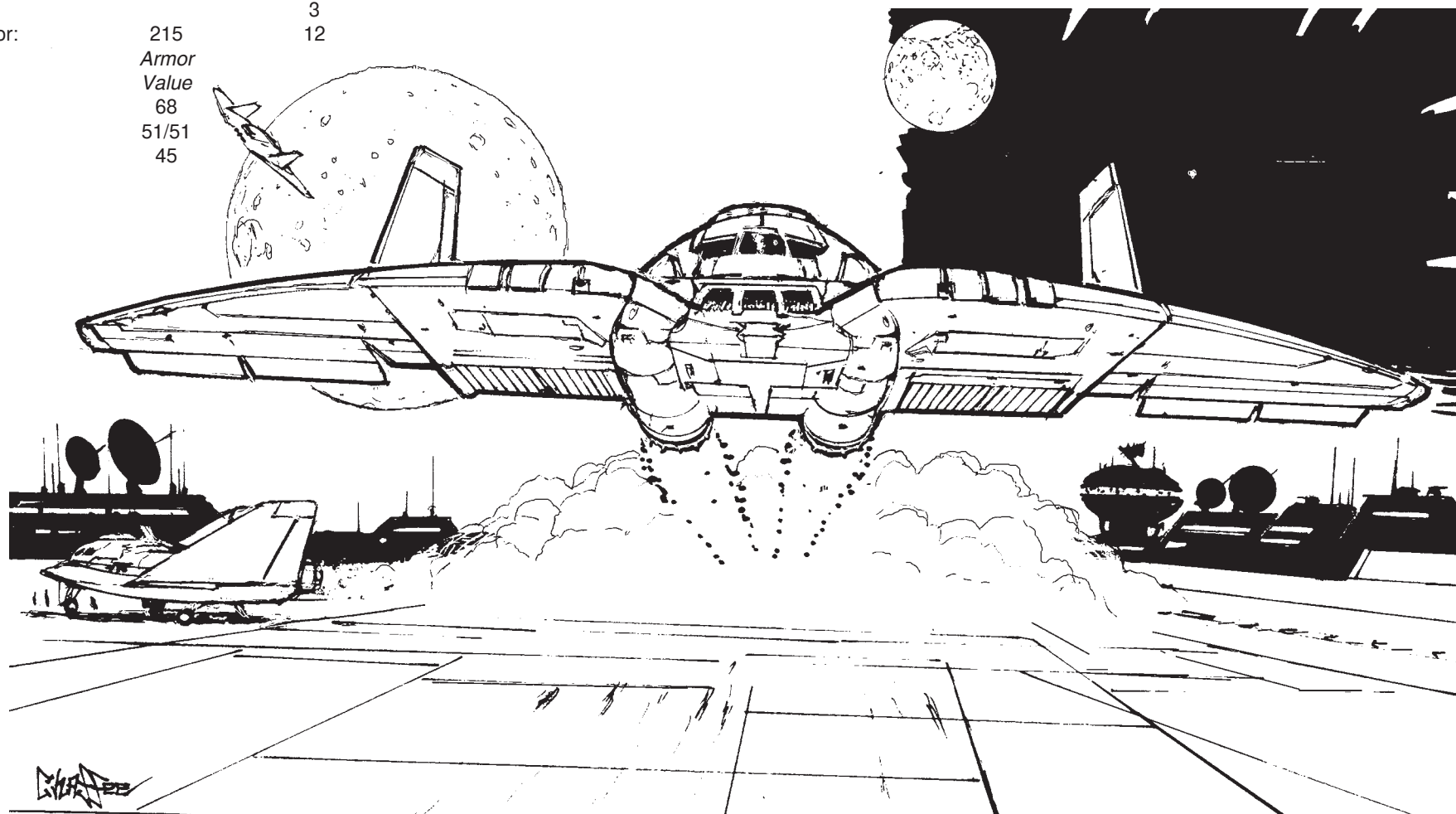



**Mass:** 60 tons

**Frame:** Saroyan 2.5

**Power Plant:** Pitban 180 Fusion

**Armor:** CarbonDale IV Ferro-Aluminum

**Armament:**

1 Starcutter PPC

4 Allied Technologies Model 2 Medium Lasers

2 Holly LRM-15 Missile Racks

2 Allied Technologies Model 1 Small Lasers

**Manufacturer:** Allied Technologies

**Primary Factory:** Stewart

**Communications System:** COMSTAT 500 ATM

**Targeting and Tracking System:** Ringo Plant 88 Mk. 2

## Overview

Lost in the annals of history, the Nova Squadron School of Combat—a lesser-known “top gun” program for FWL pilots before the SLDF adopted it—churned out less than five hundred “elite of the elites” during its heyday. Even after the SLDF began its own Supernova program, the League’s NSSOC graduates could still out-fly and outfight any other ASF pilot throughout the first two Succession Wars. With the demise of fleet engagements and aerospace assets after the Second Succession War, the NSSOC became little more than a flying social club, at times putting even Lyran social generals to shame.

In 2654, New Age Systems Inc., based on Stewart in the Marik-Stewart Commonality, recruited the top of NSSOC’s ’54 class to assist in designing a new medium fighter. The fighter, originally commissioned for the SLDF, was also envisioned as a mainstay for the League navy. By the end of a grueling three-year study in which two pilots were killed in accidents, NASI

had three excellent prototypes to showcase to visiting SLDF brass. All three prototypes were based on the same airframe model, dubbed the *Gotha*.

The SLDF used the *Gotha* extensively for naval patrols and fleet defense units. Not to be outdone, the FWL Admiralty also picked up an extended contract for the GTHA-100 series, which quickly became a mainstay and favorite of League pilots.

After the fall of the Star League, NASI nearly collapsed financially, as most of their assets and resources were tied to the SLDF. Allied Technologies, once a subsidiary of NASI, purchased the controlling percentage of the failing company and completely rebuilt it. Unfortunately, the *Gotha* line was discontinued once the League contract was finished, thanks to corporate politics.

The *Gotha* was reintroduced to the marketplace in 3019, when Allied restarted the line following a massive corporate restructuring. Maintaining a modest output (though with standard armor) for several decades, the company was approached by Word of Blake representatives in 3064 and an exclusivity contract negotiated for several hundred *Gotha* fighters—the understanding was that these fighters would be the mainstay of the newly built *Thera*-class carriers. The contract was mostly fulfilled when most of the League navy disappeared at the opening of the Jihad.

## Capabilities

Built around a hardy airframe, each *Gotha* series fits a predefined role. Because the engine mount is easily removed from the top of the fuselage, it is possible to alter any *Gotha* into any configuration. The average turnaround time for such configuration change is roughly two weeks as each engine and energy weapons replacement requires a complete recalibration.

## Deployment

A common sight among most FWL aerospace forces, the *Gotha* has become the most popular medium fighter in any of the League’s provinces. Most *Gothas* identified outside of the League are usually battlefield salvage or spoils of war, though NASI—and subsequently, Allied—has done limited production runs for foreign clients. Most recently, Allied completed a small order of fifty new GTHA-600s for an agent who is suspected to be a Clan Diamond Shark merchant.

## Variants

The most common *Gotha* is the -100 series, known for its mediocre engine but wide weapons variety. The -300 series is one of the most heavily armored medium fighters in existence, though the sixteen tons of ferro-aluminum makes this model extremely tricky to handle in atmospheric operations. Most popular is the -500 series, which sports a larger engine and a mix of long and short ranged weaponry.

New to the series line is the -600, which mounts a larger light fusion engine. Built for dogfighting and close-ranged support, the -600 sports a snub-nosed PPC with two ER medium lasers in the nose and replaces the LRM systems in the wings with four SRM six-packs. An upgrade in heat sink technology helps keep the heat curve down, though the fighter is still notoriously hot after a few minutes of furious combat.

## Notable Pilots

**Lieutenant Commander Colleen McFadden:** Kicked out of the Second Kearny Highlanders for ‘conduct unbecoming a Highlander,’ Colleen arrived on Outreach ready for action. Her well-maintained GTHA-500 *Gotha*—along with her skills—landed her several choice offers, including one from the Hell’s Black Aces; she quickly accepted. The glitter wore off, however, as the Aces become more closely tied to the Confederation; a move she considered abhorrent. Finding a sympathetic ear in Major Jason Windgate, the two remained a vocal minority for several years. During the defense of Liao in 3069-70, Colleen watched the brutal mauling of her beloved Aces and the seduction of House Liao as they cemented their control of the unit through their “help.” Despite repeated outbursts, the loss of most like-minded pilots and the infusion of so many Capellan pilots, have pushed Colleen and Major Windgate (now lieutenant, demoted for ‘conduct unbecoming a Hell’s Black Aces’ officer) into a corner. Rumors abound that an independent command has been formed, with Colleen at the head and lieutenant Windgate as her XO. Under their command: most of the last hold-outs against the Aces intentions to formally join the CCAF. The independent command, McFadden’s Skyriders, has yet to be seen in action, however.

# GTHA-500 GOTHA

Type: **Gotha**  
 Technology Base: Inner Sphere  
 Tonnage: 60  
 Battle Value: 1,454

**Equipment**

Engine: 180  
 Safe Thrust: 5  
 Max Thrust: 8  
 Structural Integrity: 6  
 Heat Sinks: 14  
 Fuel: 480  
 Cockpit: 3  
 Armor Factor: 232

**Mass**  
 7  
 4  
 6  
 3  
 13  
**Armor Value**  
 76  
 54/54  
 48

**Weapons and Ammo**

Weapons and Ammo	Location	Tonnage	Heat	SRV	MRV	LRV	ERV
PPC	Nose	7	10	10	10	—	—
2 Medium Lasers	Nose	2	3	5	—	—	—
LRM 15	RW	7	5	9	9	9	—
Small Laser	RW	.5	1	3	—	—	—
LRM 15	LW	7	5	9	9	9	—
Small Laser	LW	.5	1	3	—	—	—
Ammo (LRM) 8	—	1	—	—	—	—	—
2 Medium Lasers	Aft	2	3	5	—	—	—

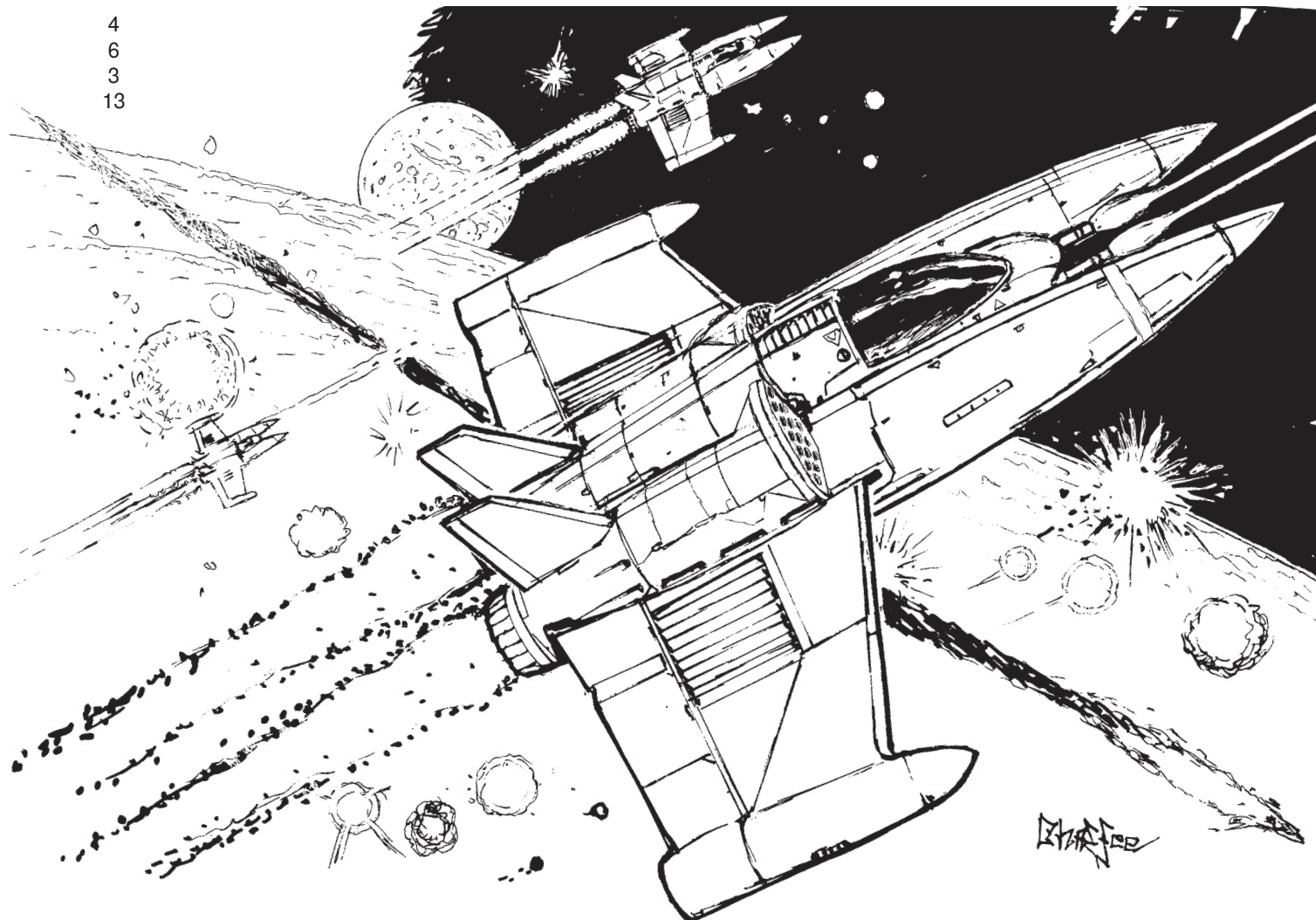

*Handwritten signature*

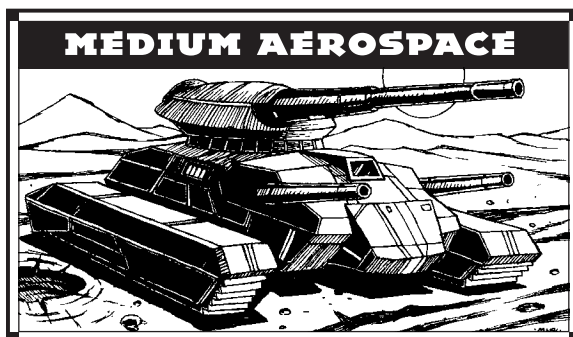

**Mass:** 65 tons

**Frame:** Lockheed FairFax

**Power Plant:** GM 260

**Armor:** SearWeave

**Armament:**

2 Exeter Technologies 1 PPCs

5 Colbalt-6 SRM-6 Launchers

2 Allied Technologies Model 2 Medium Lasers

**Manufacturer:** Brooks Manufacturing Inc.

**Primary Factory:** Liberty

**Communications System:** OP/1/2/3.66 Mk IIa

**Targeting and Tracking System:** Ryder Track IV

## Overview

Built after extensive field-testing by almost every House army, the *Ironsides* was produced with few to no defects in any capacity. Garnering such a good reputation during the three-year field survey, the SLDF bought up large quantities of this medium fighter, primarily for its devastating first-strike capability.

Nonetheless, just as many other manufacturing companies suffered during the horrors of the Succession Wars, the Brooks Manufacturing fighter suffered the same. Five facilities existed at the time of the Star League's collapse; only one remained by 2910. Situated on Carver V—now known as Liberty—the BMI plant was shut down by the company in a major cost-saving move, as the fighter found little to no respect among the current generation of aero pilots.

## Capabilities

Sporting a wide range of weaponry and a solid target & tracking system, the *Ironsides* effectively filled

many gaps in fighter technology of the time. Using a slightly smaller fusion engine design specifically molded to the airframe's centerline, the more compact engine maintained a similar output curve of other, more standard sized engines.

The biggest flaw of the *Ironsides* has always been the laser assemblies' power-chain housing and the coolant system, collectively called "the energy housing." Prone to temperature spikes when fired constantly, the power chain tends to "backflash," rupturing the chain and stressing nearby coolant hoses to the bursting point, causing a flash-explosion that can ripple into the fuselage wing roots. On rare occasions, the damage is so severe that the wings actually tear away from the fuselage during high-stress maneuvers.

Because designers during the Star League era were never able to come up with a fix for the system, pilots of older -SD1s are warned to not fire the lasers for extended periods of time. It is unknown if the newer versions of the *Ironsides* still contain this flaw.

## Deployment

Found mostly among Oriente air forces and Protectorate planetary defenses, the *Ironsides* still enjoys battlefield anonymity among the rest of known space. Most of the airframes still in service among other House forces are cared-for heirlooms or museum relics, as most modern pilots still have no respect for the venerable design.

## Variants

A much more rare variant swapped out the hotter PPCs for three Martel large lasers. Additionally, the oft-plagued medium lasers were removed, which gave the *Ironsides* additional space along the center axis to mount an additional ton of SRM ammo. The result was a very deadly interceptor that could stick around longer in developing skirmishes. Because little of the actual airframe was changed, only sharp observers could note the different design—more often than not, pilot was flamed when a supposedly empty *Ironsides* fixated on their six and tore into them with additional swarms of short-ranged missiles.

Most troubling are reports of a newer version of the *Ironsides* being produced at the BMI plant on Lib-

erty, which was reopened and modernized with WoB funds. Mounting five MRM-10s and plenty of ammunition, these heavy fighters have been seen among planetary defense forces across the Protectorate. Utilizing a single extended-range PPC and similar large laser, these newer *Ironsides* pack a decidedly heavy punch. One Federated Suns DropShip captain barely survived a scrape with six of them, his armor more tissue than structure before successfully docking with a JumpShip and escaping the Acamar zenith point.

## Notable Pilots

**Adept Maribel Johns:** Part of the Terran Security Forces assigned to the massive Titan Yards outside of Saturn's orbit, Johns has been flying her IRN-SD3 since its debut in late 3070. Previously assigned to the Ninth Division before her transfer, Johns accounted for eight solo kills during Operation Odysseus. According to analysts, it is presumed that Johns was the Adept who turned in Precentor Hettig to WOB-ROM, which led to the former Titan Yardmaster's death.

**Force Commander Gupta Leons-Marik:** So far down the tree that over one hundred individuals of the Marik line would need to die before he would have a starling's chance at claiming the Captain-Generalship, Leons-Marik enjoys the perks his half-name brings in the local bar scene. A womanizer (to put it kindly), the local wing commander of the militia's air wing turns into a pilot-savant in the cockpit. Many of his subordinates firmly believe that his skills alone keep him planted as commander, though many would also admit his continual liaison with the planetary lieutenant governor's sister also has a role to play.



# IRN-SD1 IRONSIDES

Type: Ironsides

Technology Base: Inner Sphere

Tonnage: 65

Battle Value: 1,439

**Equipment**

Engine: 260  
 Safe Thrust: 6  
 Max Thrust: 9  
 Structural Integrity: 6  
 Heat Sinks: 10 [20]  
 Fuel: 400  
 Cockpit: 3  
 Armor Factor: 184

**Mass**  
 13.5  
 0  
 5  
 3  
 11.5

*Armor Value*

Nose 61  
 Wings 36/36  
 Aft 51

**Weapons and Ammo**

Weapons and Ammo	Location	Tonnage	Heat	SRV	MRV	LRV	ERV
2 PPC	Nose	14	10	10	10	—	—
SRM 6	Nose	3	4	8	—	—	—
Ammo (SRM) 15	—	1	—	—	—	—	—
2 SRM 6	RW	6	4	8	—	—	—
2 SRM 6	LW	6	4	8	—	—	—
Medium Laser	RW	1	3	5	—	—	—
Medium Laser	LW	1	3	5	—	—	—

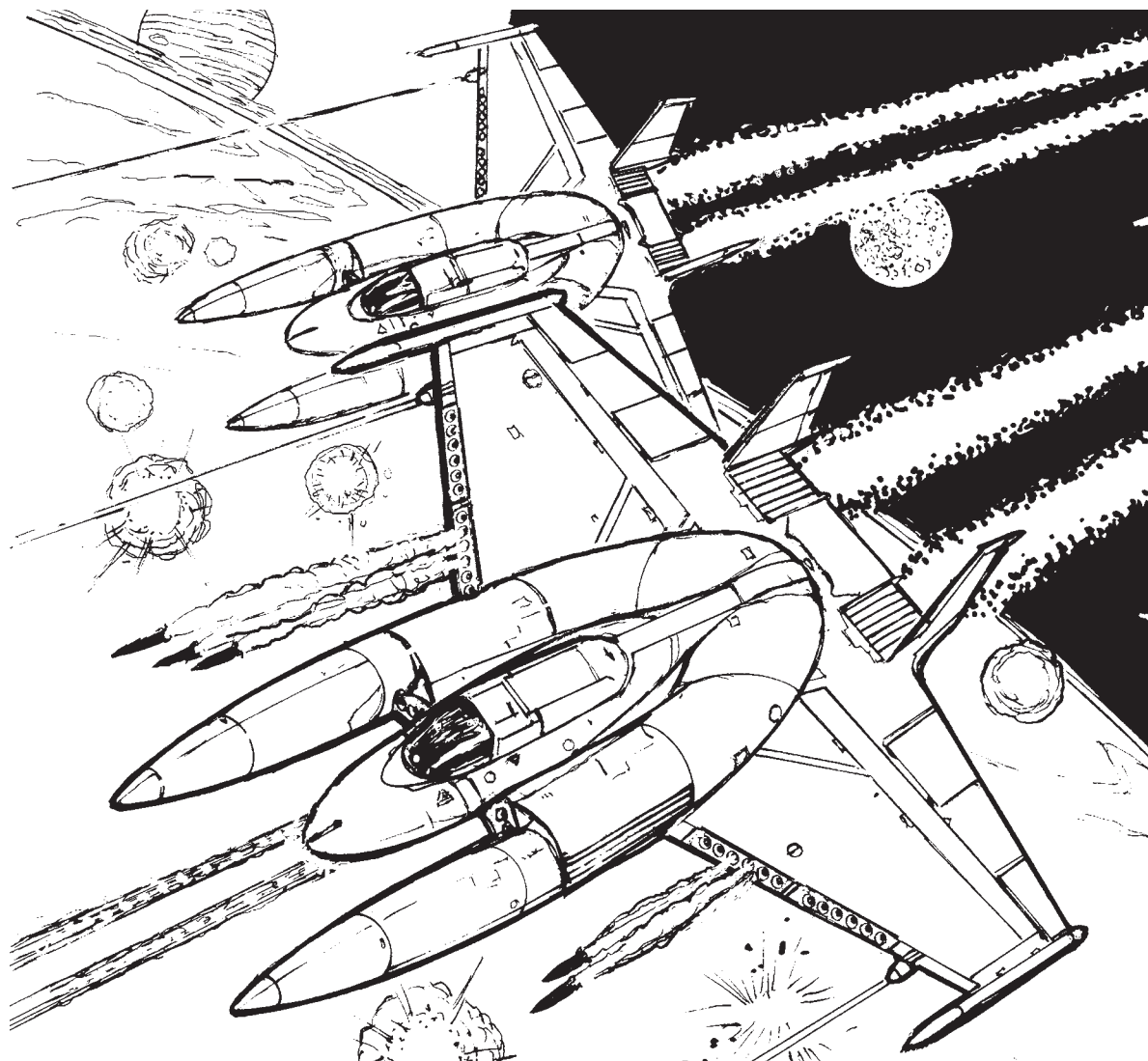

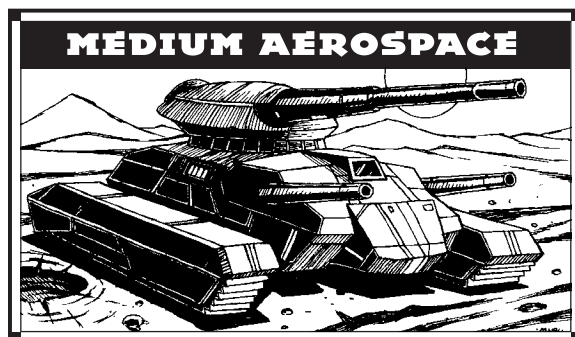

**Mass:** 75 tons

**Frame:** Lockheed BR65

**Power Plant:** Pitban C375

**Armor:** Boeing C-tran Ferro-Aluminum

**Armament:**

1 Emperor Zeta-20 Autocannon

**Manufacturer:** Boeing Interstellar

**Primary Factory:** Terra

**Communications System:** Lassitor FibroLink

**Targeting and Tracking System:** BANDAR 9

## Overview

Enemies of the Star League and its precursor, the Terran Hegemony, learned very early that planets defended by *Hammerhead* fighters were costly to attack. Ground-based squadrons of these hard-hitting fighters contested landings vigorously. It was not uncommon for admirals to refuse to allow their DropShips to enter the atmosphere until the defending *Hammerheads* were neutralized out of fear of the massive autocannon that made them so deadly.

The Word of Blake continues this tradition, although modifications to the craft have allowed them to use it as effectively from carriers as the ground. Pilots across the Inner Sphere are learning to fear the distinctive shape of the *Hammerhead's* nose once again.

## Capabilities

With startling speed for such a heavy airframe, the *Hammerhead* is often used as an attack craft. Impressive armor protection allows the fighter to pen-

etrate a target's defenses before unleashing the devastating fire of its Emperor Zeta-20 cannon. The lack of supporting weapons is considered by many to be a flaw, but many commanders realize that this forces their pilots to retreat when they are out of ammunition instead of staying in the fray to try for glory with insufficient weaponry.

## Deployment

Although it was a popular fighter during the original Star League's reign, only ComStar managed to retain sizable numbers of this hard-hitting craft during the Succession Wars, where it was deployed in almost every division of the Com Guard. Since the revelation of ComStar's military might after the Fourth Succession War, *Hammerheads* have proliferated; Brion's Legion maintained a few examples, taken from ComStar's deep caches. The Word of Blake is deploying more and more of these vintage craft, both in their own divisions and through sales to aligned states and mercenaries.

## Variants

Two variants of the *Hammerhead* have survived the Succession Wars. The first, the *Hammerhead-E*, is a simple modification intended to rectify the Zeta-20's lack of range. Two Magna Hellstar PPCs are fitted into the nose cavity where the autocannon normally resides. A heat sink is added and all eleven are retrofitted to double-strength. Two additional tons of fuel are added to increase the newly ammunition-independent *Hammerhead's* legs. This variant is popular in the Com Guard aerospace forces, especially in the squadrons based on WarShips.

The second variant has appeared across the Inner Sphere in Word of Blake squadrons. It appears that the mothballed Boeing plant near the ruins of Unity City has been refurbished and activated. Although it shares the double heat sinks of the E variant, the *Hammerhead-F* replaces the Zeta-20 with an Emperor Code Red LB 10-X autocannon with two tons of ammunition. A pair of Diverse Optics ER medium lasers are mounted beneath each wing. When these weapons are combined with the *Hammerhead's* speed and armor, the *Hammerhead-E* is a potent fighter.

There are unconfirmed reports of a small unit of *Hammerhead* fighters carrying the massive Ultra-20 cannon. If true, they have most likely given up a ton of ammunition for the larger weapon. According to rumors, these fighters are ambushing and destroying DropShips in the Marik Commonwealth but have not identified themselves.

## Notable Pilots

**Adept X Grace Falls:** Grace Falls served aboard the ISS Invisible Truth as a member of Task Force Serpent. During the engagement with Ghost Bear forces at Trafalgar, Adept Falls piloted her *Hammerhead-E* into a general assault against the supporting Bear DropShips. The minimal profile changes made to the E variant meant that the DropShip's gunners were amazed to be attacked by PPC fire instead of heavy cannon. Gun camera ROMs later confirmed it was her fire that forced the attacking *Union-C* vessels to surrender after her PPCs disabled the DropShip's drive.

Since the beginning of the Jihad, Adept Falls has commanded an independent Level II of *Hammerhead-Es*. Based from a *Leopard CV* carried by a lithium-fusion equipped *Magellan*, the Fallen Grace Squadron jumps from system to system, interdicting Blakist shipping and striking at targets of opportunity. The Word of Blake Militia has reportedly placed a large bounty on the Squadron's heads, with Adept Falls herself worth eight million C-bills.

**Demi-Precentor James Olmstead:** Demi-Precentor Olmstead leads the largest aerospace contingent—three Level IIs—in the Blakist Twenty-third Division. His unit is responsible for ground support missions, and the large block of *Hammerhead-Fs* under his command are responsible for more 'Mech and vehicle kills than any other class of fighter. The withering cluster-munition attacks, combined with deadly laser strafing runs, have made the wide-nosed fighter a feared sight on the battlefields of the former Chaos March.

# HMR-HD HAMMERHEAD

Type: Hammerhead  
 Technology Base: Inner Sphere  
 Tonnage: 75  
 Battle Value: 1,064

Weapons and Ammo	Location	Tonnage	Heat	SRV	MRV	LRV	ERV
AC/20	Nose	14	7	20	—	—	—
Ammo (AC) 15	—	3					

Equipment		Mass
Engine:	375	38.5
Safe Thrust:	7	
Max Thrust:	11	
Structural Integrity:	7	
Heat Sinks:	10	0
Fuel:	400	5
Cockpit:		3
Armor Factor:	206	11.5
	<i>Armor Value</i>	
Nose	76	
Wings	50/50	
Aft	30	

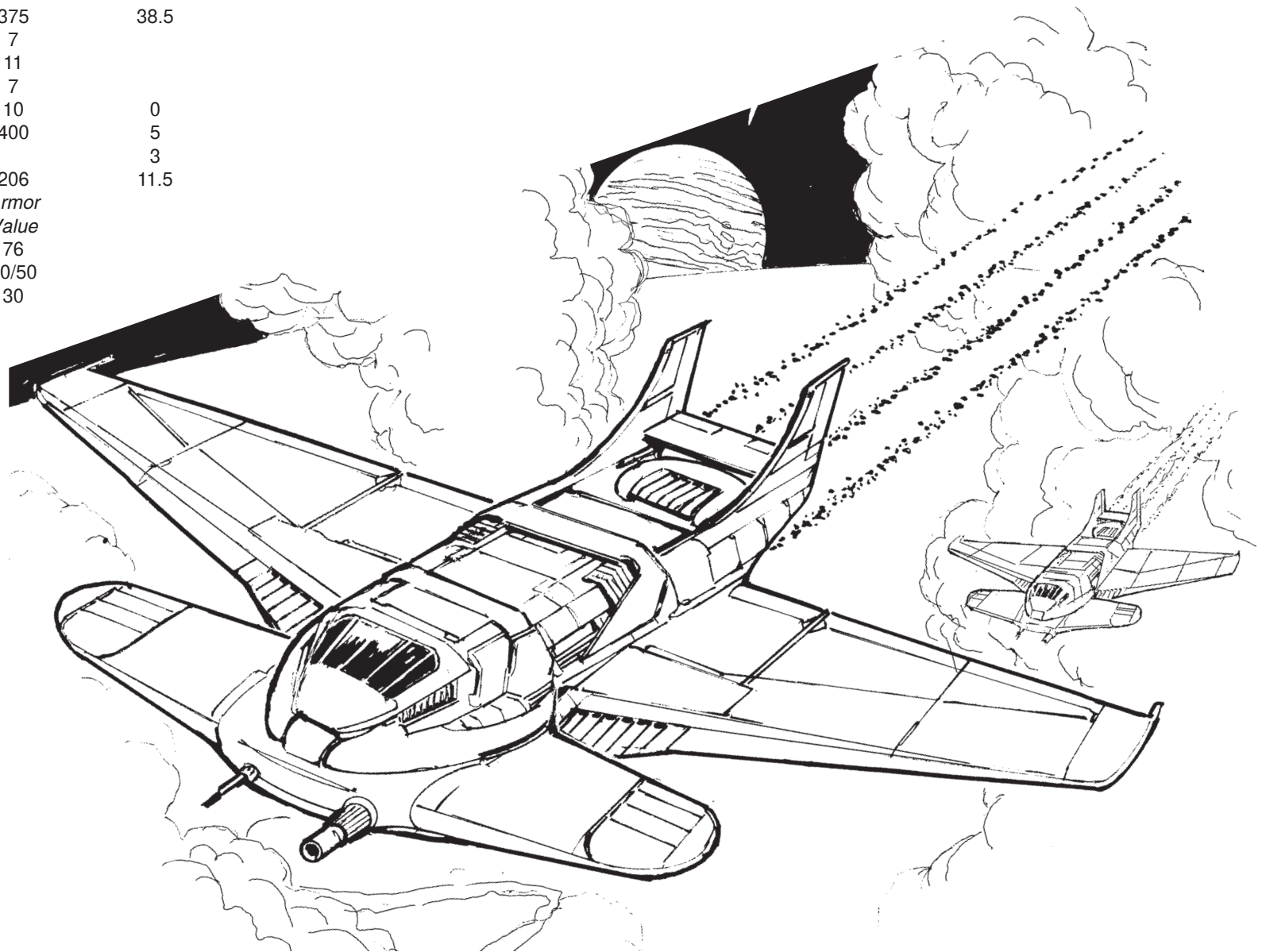



**Mass:** 85 tons

**Frame:** Interstar 290M

**Power Plant:** AeroFord 340

**Armor:** PhilterMesh

**Armament:**

- 1 RNG Ranger AC/20 Autocannon
- 2 PDVR Piledriver Model 11-D PPCs
- 1 Cavalier Industries LRM-10 System

**Manufacturer:** Bauer Enterprises

**Primary Factory:** Tharkad

**Communications System:** COMHRT II.Q

**Targeting and Tracking System:** Bauer-Scope 130Y

## Overview

Bauer Enterprises' decision to enter the military aerospace market in 2590 came as a complete shock. Better known as a maker of quality electronic toys, including remote-controlled aerospace models, few believed Bauer could live up to its grand ambitions.

But with the ongoing Reunification War having no apparent end in sight, the SLDF could not afford to ignore any proposals to expand their arsenals, no matter what the source. Bauer's heavy strike fighter design, the *Rapier*, caught the SLDF's attention with its strong mix of weaponry and high speed. Though production was delayed until 2596, the *Rapier* went on to become a staple of the Star League's heavy fighter lances.

## Capabilities

Featuring an innovative targeting system of their own design, Bauer's engineers choose the *Rapier's* weapons specifically to complement the advanced

Bauer-Scope 130Y. Twin Piledriver PPCs, mounted on the undersides of the cockpit, provided the craft's primary long-range armament. Cooling problems linked to the simultaneous firing of both PPCs caused the death of one test pilot and led to a lengthy redesign of the cockpit life support system. Though corrected prior to the fighter's combat release, most *Rapier* pilots still double check the PPCs' radiator cowls as part of their pre-flight checks.

A Cavalier Industries LRM-10 added to the *Rapier's* long-range punch; a relatively unknown system, it was capable of providing independent targeting data for each missile. When combined with the superior Scope 130Y's abilities, it enabled the pilot to make mid-flight corrections to the LRM's targeting solutions.

A nose-mounted Ranger AC/20 autocannon rounded out the craft's weaponry, delivering devastating close-in firepower. Combined with the Scope 130Y, the autocannon was able to achieve a range beyond most weapons of its type, often causing havoc for opponents unaware of the *Rapier's* unique capabilities.

## Deployment

Widely deployed in the SLDF, versions of the *Rapier*—lacking the advanced Scope 130Y targeting system at the SLDF's request—have also appeared within the Lyran Commonwealth's aerospace forces. Though its Tharkad-based factory was never attacked during the Succession Wars, the *Rapier* still suffered from the resultant loss of advanced technologies, and Bauer was unable to produce the targeting system or double heat sinks beyond the early years of the Second Succession War.

Though downgraded *Rapiers* were produced sporadically throughout the Succession Wars, the design never regained its prominence and was slowly phased out in favor of newer designs. Both ComStar and the Word of Blake are known to field Star League-era *Rapiers*.

Bauer Enterprises were reportedly looking into producing an upgraded version of the *Rapier*, slated for testing in 3068, though it is believed the factory lines were destroyed during the Word's assault of Tharkad in late 3067.

## Variants

Bauer Enterprises produced a number of variants of the *Rapier*, mostly for mission-specific roles. The RPR-101 was designed as a ground-attack craft and removed both the autocannon and LRM systems in favor of more energy-based weaponry. A third PPC was added to the nose, a medium laser was mounted in each wing to give the craft superior strafing abilities. Finally, a pair of aft-mounted medium lasers was installed to cover the craft's vulnerable rear. To help minimize losses from concentrated ground fire, the craft's armor was boosted by an extra three tons. The massive heat burden of the new weapons load were addressed with an extra eight double heat sinks, though careless pilots can still easily overheat the craft.

Produced exclusively for SLDF's Royal Regiments, the RPR-200 series featured the latest technological advances. Both PPCs were upgraded to ER versions, while the AC/20 was exchanged for an LB 10-X autocannon. Two extra double heat sinks help keep the fighter cool, while thirteen tons of ferro-aluminum armor provides a deadly surprise for craft of unwary opponents.

The downgraded Succession Wars variant, RPR-102, exchanged the PPCs for large lasers and used the freed mass to add four single heat sinks.

According to intercepted Blakist reports from Tharkad, *Rapiers* sporting heavy Gauss rifles and PPCs have been responsible for a high number of Blakist casualties, suggesting Bauer's production facilities may not have been entirely destroyed.

## Notable Pilots

**Captain McArthur Purvis Fullerton:** One of the most famous pilots to have never lived, Captain Fullerton was the star of long-running holo-drama *Wings of Glory*. Featuring the courageous exploits of the 2525th Independent Air Wing, the show captured public imagination across the Inner Sphere. The resulting positive publicity raised the *Rapier's* profile immeasurably, resulting in greatly improved sales—much to the satisfaction of Bauer Enterprises.

# RPR-100 RAPIER

Type: **Rapier**  
 Technology Base: Inner Sphere  
 Tonnage: 85  
 Battle Value: 1,540

**Equipment**

Engine: 340  
 Safe Thrust: 6  
 Max Thrust: 9  
 Structural Integrity: 8  
 Heat Sinks: 12 [24]  
 Fuel: 400  
 Cockpit: 3  
 Armor Factor: 192  
 Armor Value  
 Nose 63  
 Wings 40/40  
 Aft 49

Weapons and Ammo	Location	Tonnage	Heat	SRV	MRV	LRV	ERV
AC/20	Nose	14	7	20	—	—	—
Ammo (AC) 10	—	2	—	—	—	—	—
2 PPC	Nose	14	10	10	10	—	—
LRM 10	Nose	5	4	6	6	6	—
Ammo (LRM) 12	—	1	—	—	—	—	—

**Mass**  
 27

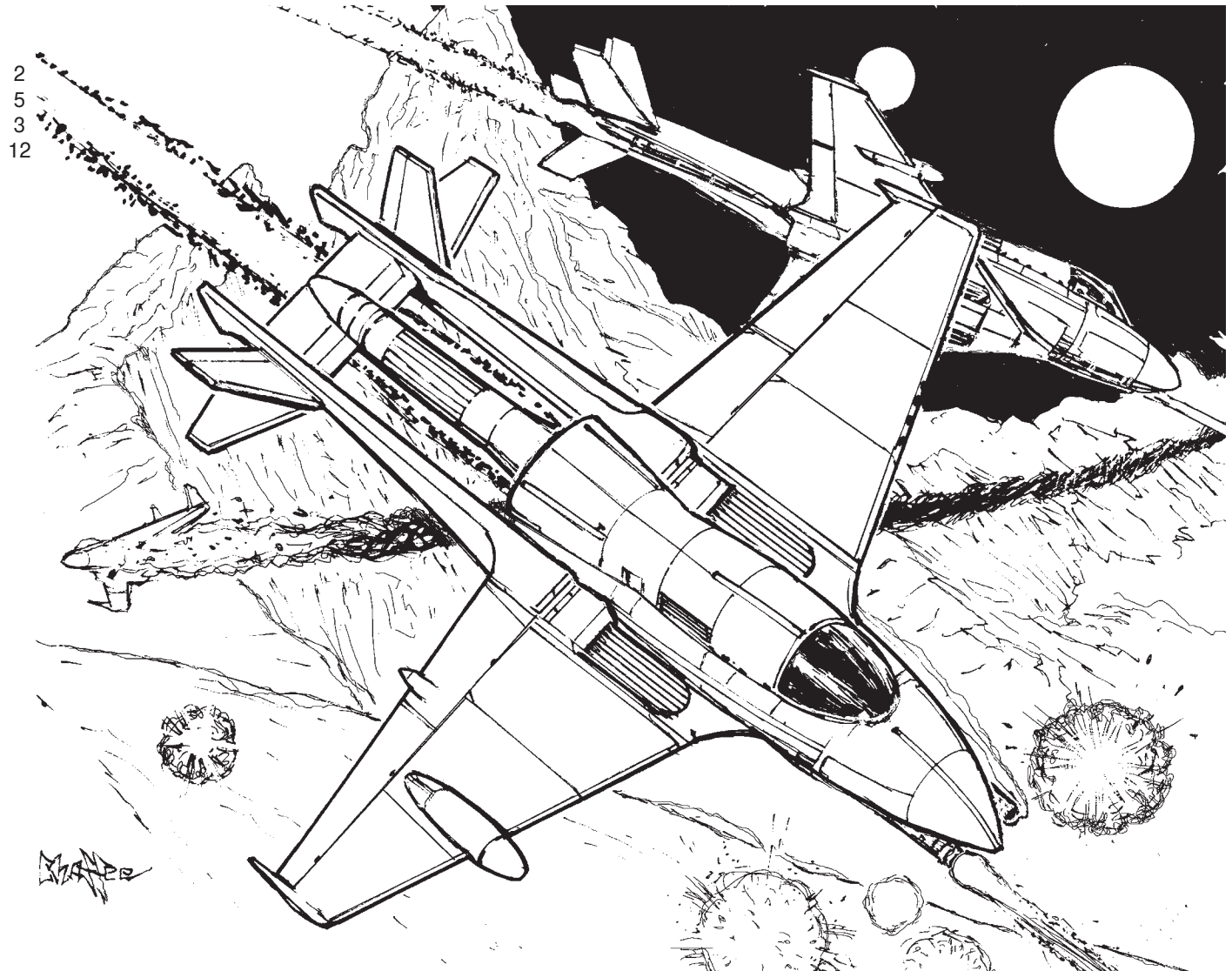



**Mass:** 90 tons

**Frame:** Wakazashi Heavy Unlimited

**Power Plant:** PlasmaStar 270

**Armor:** Force Plus

**Armament:**

- 1 Thunderbolt 2C Large Laser
- 1 Apple Churchill Guiding Light Narc Missile Beacon
- 2 Delta Dart LRM-20
- 2 Federated-6 SRM-6
- 2 Ceres Arms Medium Laser

**Manufacturer:** Bannock-Braigh Aerospace

**Primary Factory:** Terra

**Communications System:** MyComm LVR

**Targeting and Tracking System:** Antron 7

## Overview

Debuting in 2697, the *Ahab* heavy fighter made an immediate impact in combined-arms warfare. The *Ahab* was designed from the start as a highly mobile missile platform. SLDF commanders who had these craft assigned to them used them to devastating effect against heavily fortified installations. *Ahabs* were also a welcome sight in several task forces, and it was common for a full squadron to take down light- and medium-class DropShips in one pass.

Originally produced by the Harvard Company, Inc., *Ahab* production changed hands to Bannock-Braigh Aerospace in the early 3000s when HCI went under due to financial malfeasance. BBA built limited numbers of the fighter at first, concentrating on manufacturing spare parts and minor upgrade packages for

the remaining *Ahabs* in service to ComStar. BBA conveniently neglected to provide such packages to other military units; consequently, *Ahabs* in service to the Great Houses fell into disuse and disrepair.

In 3061, BBA began manufacturing two new variants of the venerable fighter. Though BBA began making parts and upgrade packages for the new SLDF and other House militaries, the new variants have not been seen outside of the Word of Blake military.

## Capabilities

The original *Ahab* featured both long- and short-range wing-mounted missile packs with enough ammunition to carry out several passes. When later coupled with a NARC beacon, the *Ahab's* delivery system was exceptionally accurate.

Perhaps the most glaring weakness of the design according to most pilots is the low acceleration rate of the PlasmaStar fusion engine. Likened to a “floundering moose in molasses,” the *Ahab* takes critical seconds to reach a desired speed. Though the design mounts two Ceres Arms medium lasers in the rear arc, the lighter armor is small comfort for edgy pilots performing precision strikes in heavily defended territory.

## Deployment

Of all the House militaries, the Free Worlds League fields the largest number of *Ahabs*. The League Admiralty assigns most of these heavy fighters to nadir and zenith stations for system defense instead of the League's newer WarShips.

The newer variants are mostly seen among Protectorate Militia forces, though *Ahabs* have featured in some of the more violent campaigns of the Jihad to date. Notably, several *Ahab* squadrons cracked the three main fortresses on Dieron during the Blakist siege of the planet, which finally turned the tide against the Combine.

Some mercenary forces employed by the Word of Blake are also noted to field some of the newer *Ahabs*, though always alongside Protectorate forces.

## Variants

The prototype version of the *Ahab* did not mount a NARC system but instead had three additional medium

lasers mounted alongside the Thunderbolt system in the nose. This version has not been seen in service in almost two hundred years.

Of the two newer versions seen today, the most common is the AHB-643, which mounts a heavy PPC in the nose flanked by two medium lasers. Gone are the long- and short-ranged launchers, replaced with underslung MRM-40s in the wings with a limited ammo supply. For an extra punch, two rocket pods are mounted on the wingtips.

The deadliest variant is also the most recent arrival and has not been seen among ground attack forces. A large pulse laser and two medium lasers are nose-mounted and guided by a targeting computer, giving this version some dog fighting capability. However, this new variant is known (and feared by many DropShip captains) for the Alamo hardpoints found under the MRM-40 launchers on each wing. Many commercial DropShips have surrendered without a shot fired when faced with a squadron of these deadly fighters and their nuclear arsenal.

## Notable Pilots

**Wing Commander Shawna White:** Commander of Wannamaker's Flying Widows, White immediately traded her venerable *Ironsides* for one of BBA's new AHB-643 variants, and her impulsive purchase put the Widows into “company store” debt with the Blakists. Commander White has no regrets, however, as the immense firepower at her fingertips has boosted her confidence to new heights as she took down a Wolf-in-Exile *Confederate* during the '68 “rescue mission” with two well-placed salvos.

**Major Hubert “Cat” Nevarro:** Nevarro's venerable fighter forms the cornerstone of Fronc's planetary defense force. Numbering exactly three fighters, all heavy, Nevarro has his work cut out for him. So far, the small defensive force has repelled exactly one raid, claiming two *Sparrowhawks* belonging to Warrick's War Riders, a new pirate band operating throughout the Reaches.

# AHB-443 AHAB

Type: **Ahab**  
 Technology Base: Inner Sphere  
 Tonnage: 90  
 Battle Value: 1,792

**Equipment**

		<b>Mass</b>
Engine:	270	14.5
Safe Thrust:	5	
Max Thrust:	8	
Structural Integrity:	9	
Heat Sinks:	14	4
Fuel:	400	5
Cockpit:		3
Armor Factor:	248	15.5
	<i>Armor Value</i>	
Nose	84	
Wings	59/59	
Aft	46	

**Weapons and Ammo**

	<b>Location</b>	<b>Tonnage</b>	<b>Heat</b>	<b>SRV</b>	<b>MRV</b>	<b>LRV</b>	<b>ERV</b>
Large Laser	Nose	5	8	8	8	—	—
Narc Missile Beacon	Nose	3	0	—	—	—	—
Ammo (Narc) 24	—	4					
LRM 20	RW	10	6	12	12	12	—
SRM 6	RW	3	4	8	—	—	—
LRM 20	LW	10	6	12	12	12	—
SRM 6	LW	3	4	8	—	—	—
Ammo (LRM) 36	—	6					
Ammo (SRM) 30	—	2					
2 Medium Lasers	Aft	2	3	5	—	—	—

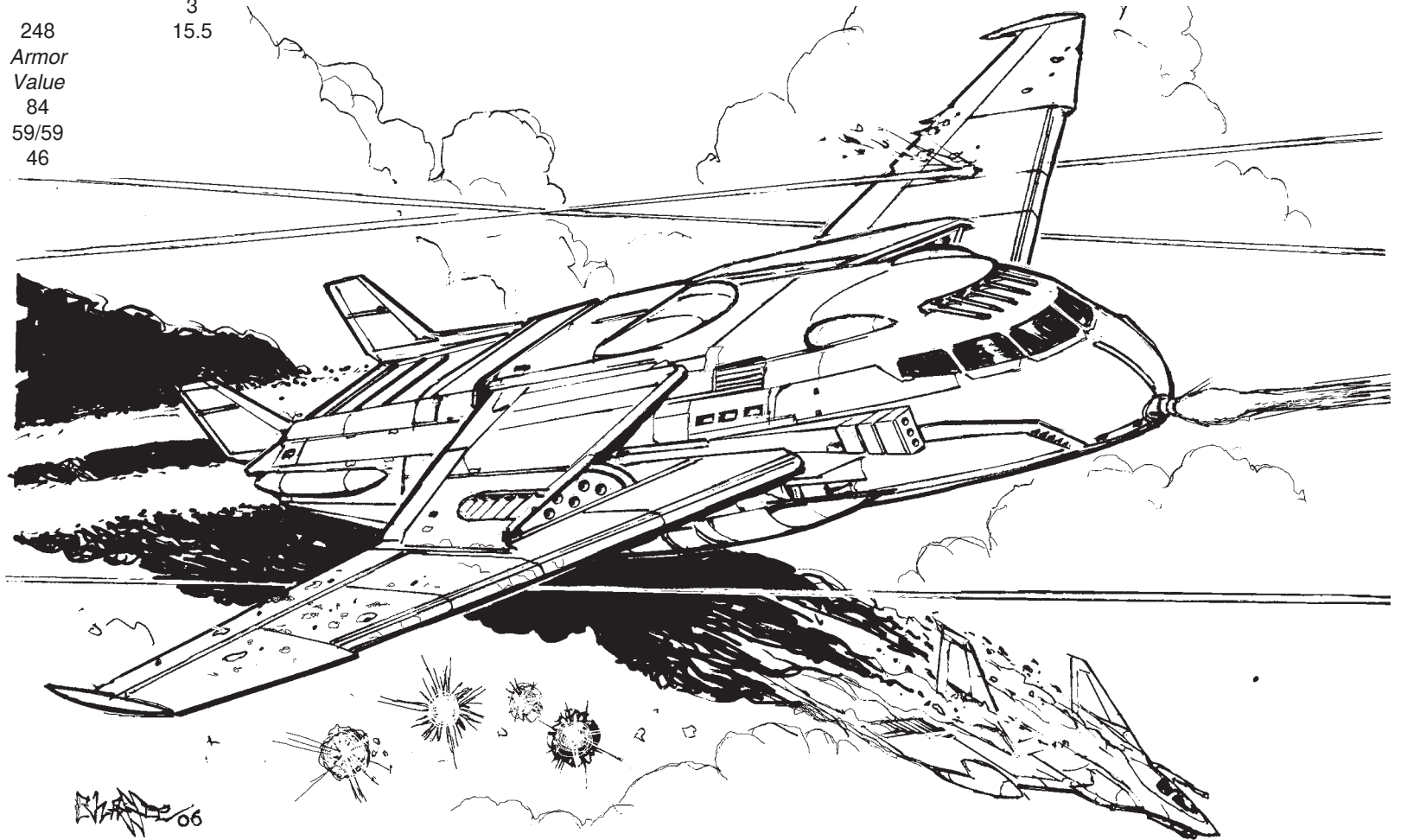

# TECHNOLOGICAL RENAISSANCE

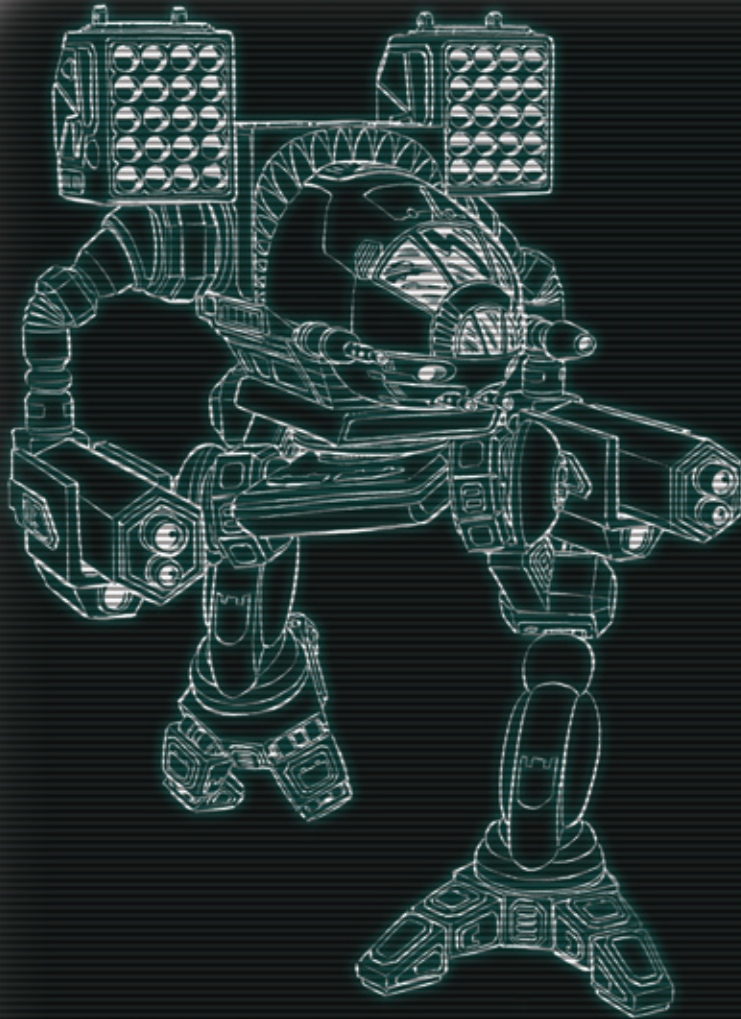

Over two hundred and fifty years ago, General Aleksandr Kerensky departed human-occupied space, taking three-quarters of the Star League Defense Force with him. They returned in 3050 as the Clans: a society dedicated to the highest warrior ideals and bent on conquering the Inner Sphere. With their OmniMechs and superior technology, they proved almost unstoppable until their defeat at Tukayyid and subsequent 15 year truce. The year is now 3071, and the Jihad rages. Inner Sphere 'Mechs, hastily upgraded with field modifications to counter the Clans, continue to prove their worth. Notable pilots rise to become heroes as new, time tested variants—sporting weapons right out of R&D labs—make their presence known. And over it all, Clan OmniMechs continue to prove they are still the cutting edge of technology.

Classic BattleTech Technical Readout: 3050 Upgrade™ fully updates this venerable product, fleshing out the history of each design, including notable MechWarriors/pilots, as well as providing fresh illustrations. Additionally, all the 'Mechs, vehicles and aerospace fighters originally found in the now out-of-print Technical Readout: 2750 are included.

FOR USE WITH  
CLASSIC  
**BATTLETECH**™

  
**CATALYST**  
game labs™

Under License From

**WK**™  
GAMES

